



2N[®] BRI Lite/Enterprise



User Manual

Firmware 1.25.0
Version 1.13

www.2n.cz

The 2N TELEKOMUNIKACE a.s. is a Czech manufacturer and supplier of telecommunications equipment.



The product family developed by 2N TELEKOMUNIKACE a.s. includes GSM gateways, private branch exchanges (PBX), and door and lift communicators. 2N TELEKOMUNIKACE a.s. has been ranked among the Czech top companies for years and represented a symbol of stability and prosperity on the telecommunications market for almost two decades. At present, we export our products into over 120 countries worldwide and have exclusive distributors on all continents.



2N[®] is a registered trademark of 2N TELEKOMUNIKACE a.s. Any product and/or other names mentioned herein are registered trademarks and/or trademarks or brands protected by law.



2N TELEKOMUNIKACE a.s. administers the FAQ database to help you quickly find information and to answer your questions about 2N products and services. On www.faq.2n.cz you can find information regarding products adjustment and instructions for optimum use and procedures „What to do if...“.



2N TELEKOMUNIKACE a.s. hereby declares that the 2N[®] BRI Lite/Enterprise product complies with all basic requirements and other relevant provisions of the 1999/5/EC directive. For the full wording of the Declaration of Conformity see the CD-ROM (if enclosed) or our website at www.2n.cz.



The 2N TELEKOMUNIKACE a.s. is the holder of the ISO 9001:2009 certificate. All development, production and distribution processes of the company are managed by this standard and guarantee a high quality, technical level and professional aspect of all our products.

Content

1. Product Overview	5
1.1 Product Description	6
1.2 Safety Precautions	9
1.3 Upgrade	10
1.4 Terms and Symbols Used	11
2. Description and Installation	12
2.1 Before You Start	13
2.2 Brief Installation Guide	17
2.3 Available ISDN BRI Extension Configurations	23
2.4 IP Voice Transmission	24
2.5 Types of 2N® BRI Enterprise Connection	27
3. Making Calls via BRI Gateway	30
3.1 Supported 2N BRI Gateway Functions	31
3.2 Call Routing Principles	32
4. First Launch	40
4.1 Ethernet Interface	41
4.2 Licence	43
4.3 Firmware Version	44
4.4 Factory Reset	45
4.5 Basic Configuration – Step by Step	46
5. Introduction to Configuration Interface	47
5.1 Configuration Web Interface	48
6. Advanced Configuration	100
6.1 LAN Communication Setting	101
6.2 GSM Gateway Behaviour	102
6.3 List of Terminal AT Commands	103
6.4 Status Messages	109
6.5 LOG Files	118
6.6 Call Data Records (CDR)	120
6.7 SMS Data Records (SDR)	121
6.8 Statistics - Description	122

7. Technical Parameters	126
8. Supplementary Information	128
8.1 Troubleshooting	129
8.2 List of Abbreviations	130
8.3 Directives, Laws and Regulations	132
8.4 General Instructions and Cautions	133

1. Product Overview

In this section, we introduce the **2N[®] BRI Lite / Enterprise** product, outline its application options and highlight the advantages following from its use.

Here is what you can find in this section:

- [1.1 Product Description](#)
- [1.2 Safety Precautions](#)
- [1.3 Upgrade](#)
- [1.4 Terms and Symbols Used](#)

1.1 Product Description

The **2N[®] Enterprise / BRI Lite** GSM gateway provides direct interconnection of the ISDN with GSM networks. It can also be used for direct interconnection of an ISDN PBX with a GSM network, ISDN telephone set and, via a terminal adapter, with an analogue apparatus or coin machine. The voice mode, i.e. outgoing and incoming calls, is the basic function of the gateway. Moreover, the BRI gateway provides connection to the VoIP-SIP networks. The gateway is equipped with all functions necessary for this mode and is very user-friendly. In addition, **2N[®] BRI Enterprise / BRI Lite** allows you to send and receive SMS messages. No additional devices (an external telephone, e.g.) are required for normal operation. All gateway parameters can be set using a configuration program (on an enclosed CD), or using the AT commands. Programmable parameters are pre-set to make it possible to make calls as soon as the supply cable, antenna a SIM cards are connected.

2N[®] BRI Enterprise / 2N[®] BRI Lite Differences

The **2N[®] BRI Enterprise** and **2N[®] BRI Lite** gateways are based on one and the same type of hardware and apply identical firmware and control (configuration) software. The only difference lies in the count of BRI ISDN interfaces:

Interface	2N [®] BRI Lite	2N [®] BRI Enterprise
BRI ISDN	1 (NT/TE)	2 (1 TE ; 1 NT)
Ethernet	YES*	YES*

*The VoIP-SIP support depends on Part No. (subject to licence).

Telephone Cost Cuts

- Having connected **2N[®] BRI Enterprise / BRI Lite** to your ISDN PBX, you can make calls to the mobile network directly. **This saves your PSTN – GSM connection costs.**
- **You do not pay for barred calls.** You can set groups of barred numbers in the gateway.
- A flexible setting of the Least Cost Router helps you **call GSM numbers at minimum operational costs.**
- You can route calls to alternative providers' networks via the VoIP/SIP interface.
- **As all gateway user calls are added up for billing purposes**, you are advised to use the most advantageous tariff offered by your provider.

2N[®] BRI Enterprise / 2N[®] BRI Lite Basic Features

- Integration of the best features of two communication technologies: ISDN and GSM
- VoIP–SIP telephony support with G.711a/u and G.729ab codecs¹
- Intelligent routing of incoming and outgoing calls
- Web interface for gateway configuration and SMS sending/receiving
- Automatic no answer SMS sending for GSM networks
- Automatic missed call SMS in the GSM network
- Simple recording of a welcome note, DISA voice message
- Automatic recording of call data and detailed statistics (CDR)
- ENBLOCK/OVERLAP ISDN dialling switch option
- Monitoring of ISDN BRI line statuses and alarm SMS sending option
- Automatic sending of Alive SMS in user-defined intervals
- Easy firmware upgrade via a configuration program
- External synchronising source connection option (BRI Enterprise)
- Mobility Extension² support.
- SNMP error traps¹
- Sending/receiving SMS via SMTP/POP3₁
- Sending/receiving SMS via SMPP₁

[1] Depending on the licence

[2] Will be available in early 2013

DialThru (2N[®] BRI Enterprise)

The difference between **2N[®] BRI Enterprise** and **2N[®] BRI Lite** lies in the DialThru functionality. DialThru enables the gateway to be connected between the PBX and the voice service provider line, i.e. PSTN. The GSM gateway in the DialThru mode routes, based on the LCR, calls into the PSTN or GSM/UMTS networks.

Refer to the figure below for a schematic diagram of the **2N[®] BRI Enterprise** connection.

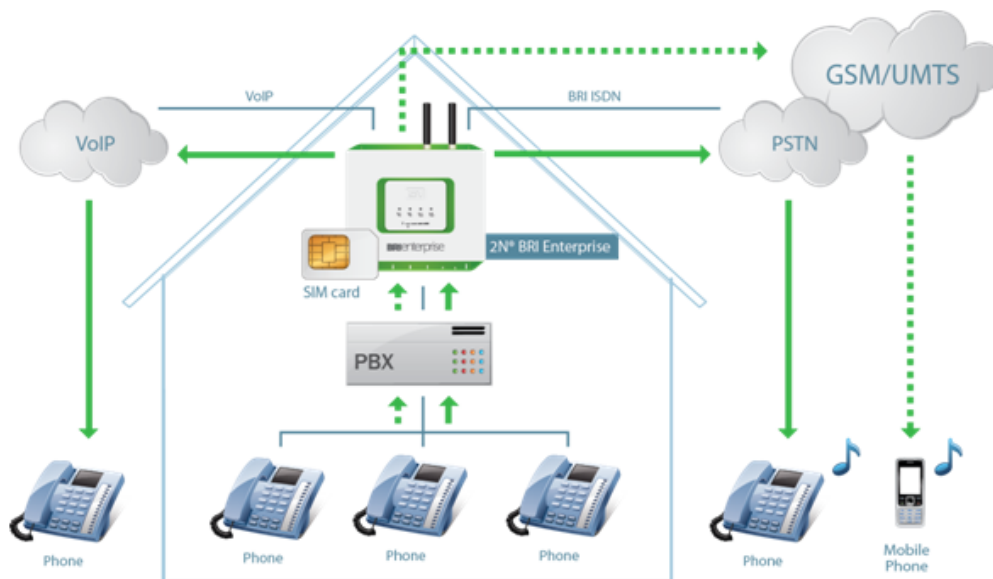

The gateway works as a dial-through router (using both the TE and NT ports in the DialThru mode) for calls to a mobile network, and a monitoring system, which, with the appropriate licence, sends SMS to the provider (in the case of line unavailability, e.g.).

The **2N[®] BRI Lite** GSM gateway contains just one ISDN BRI port and thus cannot work in the DialThru mode. It can be connected to a PBX on a trunk line or extension and route calls to the GSM/UMTS networks only – see the figure below.

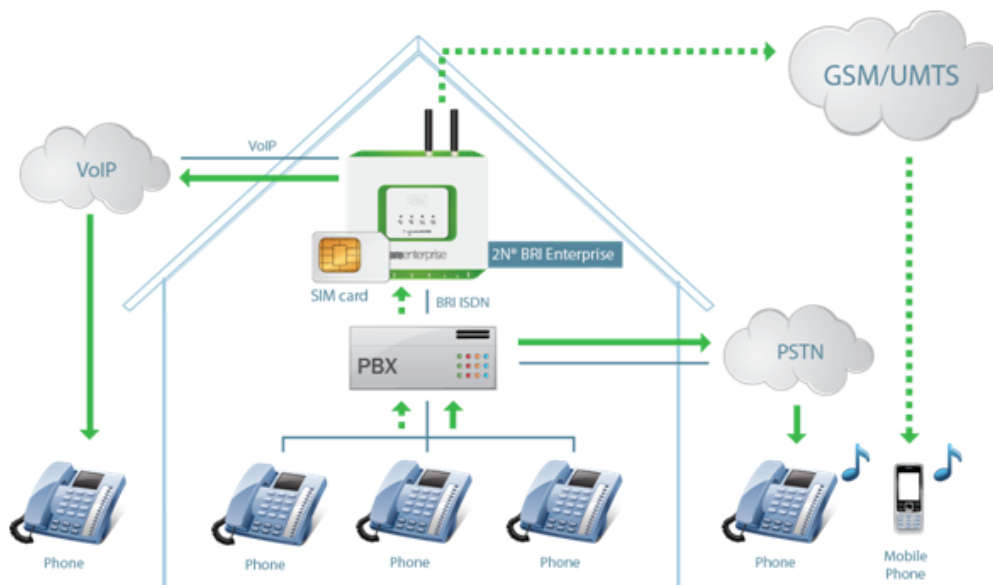

1.2 Safety Precautions

It is prohibited to use any transmitters, including the GSM/UMTS gateways, in areas where explosives are used, such as quarries.

It is prohibited to use the **2N[®] BRI Enterprise / BRI Lite** GSM gateways at petrol stations where mobile telephones are also prohibited.

GSM phones may affect sensitive life-saving devices in medical centres. Therefore, it is forbidden to use GSM/UMTS devices, including the GSM gateways, in such facilities.

In general, any prohibition regarding mobile phones based on RF energy radiation applies to GSM/UMTS devices too.

If necessary, the GSM gateways may be installed at a safe distance from the prohibited area and connected with the original place through an Ethernet cable.

Although GSM gateways are not intended for cars or aeroplanes, all relevant prohibitions and regulations regarding mobile phones apply to them too.

1.3 Upgrade

The manufacturer reserves the right to modify the product in order to improve its qualities.

In response to the customers' requirements, the manufacturer constantly improves the software contained in the product (firmware). For the latest **2N® BRI Enterprise / 2N® BRI Lite** firmware version and the User Manual refer to the 2N [web sites](#).

Refer to the [S. 2, Description and Installation](#), for a detailed description of the **2N® BRI Enterprise / 2N® BRI Lite** firmware upgrade.

Manual Version	Changes
1.0	The User Manual relates to the 2N® BRI Enterprise / BRI Lite firmware version 1.5.0 .
1.3	The User Manual relates to the 2N® BRI Enterprise / BRI Lite firmware version 1.5.0 . Text correction.
1.4	The User Manual relates to the 2N® BRI Enterprise / BRI Lite firmware version 1.14.0 .
1.5	The User Manual relates to the 2N® BRI Enterprise / BRI Lite firmware version 1.16.5 .
1.6	The User Manual relates to the 2N® BRI Enterprise / BRI Lite firmware version 1.17.0 .
1.7	The User Manual relates to the 2N® BRI Enterprise / BRI Lite firmware version 1.18.1 .
1.8	The User Manual relates to the 2N® BRI Enterprise / BRI Lite firmware version 1.19.1 .
1.9	The User Manual relates to the 2N® BRI Enterprise / BRI Lite firmware version 1.22.0 .
1.10	The User Manual relates to the 2N® BRI Enterprise / BRI Lite firmware version 1.22.0 . Text correction.
1.11	The User Manual relates to the 2N® BRI Enterprise / BRI Lite firmware version 1.23.0 .
1.12	The User Manual relates to the 2N® BRI Enterprise / BRI Lite firmware version 1.24.0 .
1.13	The User Manual relates to the 2N® BRI Enterprise / BRI Lite firmware version 1.25.0 .

1.4 Terms and Symbols Used

Manual Symbols

The following symbols and pictograms are used in the manual:

**Safety**

- **Always abide** by this information to prevent persons from injury.

**Warning**

- **Always abide** by this information to prevent damage to the device.

**Caution**

- **Important information** for system functionality.

**Tip**

- **Useful information** for quick and efficient functionality.

**Note**

- Routines or advice for efficient use of the device.

Future Functions, Innovations

The **grey-marked text** in this document designates the functions that are under preparation or development at present.

2. Description and Installation

This section describes the **2N[®] BRI Enterprise / 2N[®] BRI Lite** product and its installation.

Here is what you can find in this section:

- [2.1 Before You Start](#)
- [2.2 Brief Installation Guide](#)
- [2.3 Available ISDN BRI Extension Configurations](#)
- [2.4 IP Voice Transmission](#)
- [2.5 Types of 2N[®] BRI Enterprise Connection](#)

2.1 Before You Start

Caution

- Make sure that you are equipped with all system components necessary for putting **2N® BRI Enterprise / Lite** in operation (SIM card, ISDN phone and/or duly configured ISDN BRI line of your PBX or PSTN, an available Ethernet/USB socket and a PC for initial gateway configuration).

Product Completeness Check

Before installing this product, check whether the **2N® BRI** gateway delivery complies with the following packing list:

Package	BRI Lite	BRI Enterprise
2N® BRI Enterprise / Lite	1	1
Power supply adapter	1	1
Long antenna	1 - 2*	1 - 2*
Ethernet cable	1	1
BRI ISDN cable	1	2
Wall mounting set	1	1

*depends on the Part No.

Connector Lay-Out – Lower Side

The following connectors are available on the BRI gateway bottom:

Connector type	BRI Lite	BRI Enterprise
DC Jack 2.1mm supply connector	YES	YES
10/100BaseT Ethernet connector	YES	YES
ISDN BRI TE interface	NO	YES
ISDN BRI NT interface	NO	YES
ISDN BRI NT/TE interface	YES	NO

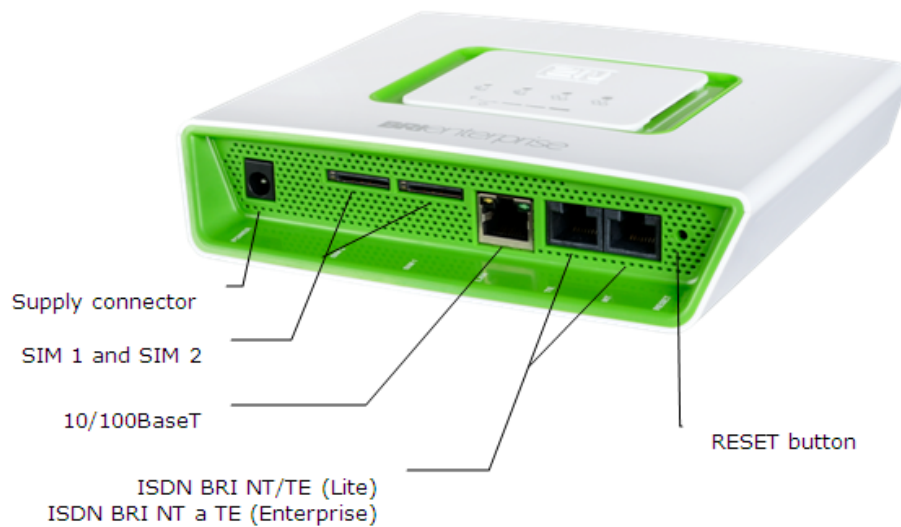

Caution





- **2N[®] BRI Lite** has two RJ-45 connectors, which, however, are cross-connected into one ISDN BRI. Be sure to connect just one ISDN BRI line to make the system work properly. Which of the RJ-45 connectors will be used depends on the type of the equipment to be connected (NT/TE) and the interconnecting cable (cross/straight).

Connector Lay-Out – Upper Side

There are SMA female antenna connectors to each GSM/UMTS module on the **2N[®] BRI Enterprise / Lite** upper side.

Status LED Indicators – 2N[®] BRI Lite





The **2N[®] BRI Lite** status is indicated by five LEDs on the front side. BRI 1 and BRI 2 indicate the status of ISDN BRI B-channels and CH 1 and CH 2 indicate the status of each GSM/UMTS module. Refer to the table below for the statuses

LED Indicators		
Power supply		green light – mains powered no light – device switched off
GSM/UMTS network		green light – call in progress red light – error green flashing – network registration, SMS red flashing – module restart Red/green flashing – signal intensity indication
ISDN port		green light – 2 calls in progress green flashing – ISDN synchronisation/active call red light – ISDN disconnected red flashing – synchronisation of lower ISDN layers
Ethernet port		green light + no orange light – disconnected green light + orange flashing – 100BaseT connected, in operation no green light + orange light – 10baseT connected, no operation green flashing + orange flashing – 10BaseT connection, in operation
Signal intensity		Signal intensity indication: one segment = less than –109dbm two segments = more than –95dbm three segments = more than –81dbm four segments = more than –65dbm

*If the devices have been interconnected, the layers will not be connected until the first call.

Status LED Indicators – 2N[®] BRI Enterprise

The 2N[®] BRI Enterprise status is indicated by five LEDs on the front side. BRI 1 and BRI 2 indicate the status of ISDN BRIs and CH 1 and CH 2 indicate the status of each GSM/UMTS module. Refer to the table below for the statuses.

LED Indicators		
Power supply		green light – mains powered no light – device switched off
GSM/UMTS network		green light – call in progress red light – error green flashing – network registration, SMS red flashing – module restart Red/green flashing – signal intensity indication
ISDN port		green light – 2 calls in progress green flashing – ISDN synchronisation/active call red light – ISDN disconnected red flashing – synchronisation of lower ISDN layers
Ethernet port		green light + no orange light – disconnected green light + orange flashing – 100BaseT connected, in operation no green light + orange light – 10baseT connected, no operation green flashing + orange flashing – 10BaseT connection, in operation
Signal intensity		Signal intensity indication: one segment = less than –109dbm two segments = more than –95dbm three segments = more than –81dbm four segments = more than –65dbm

* If the devices have been interconnected, the layers will not be connected until the first call.

**Remember to set the signal intensity indication in the gateway configuration menu.

Potential GSM/UMTS Troubles

All **2N**[®] **GSM** gateways work reliably under a long-time full load. The following problems may be caused by GSM/UMTS networks:

- The GSM/UMTS module(s) cannot log in, log in slowly, or log out occasionally. This problem may be caused by any of the following situations:
 - The GSM/UMTS signal is low. The minimum signal level should be approximately **–80dBm**. If lower, change the antenna position or type!
 - The GSM/UMTS cell (BTS) to which the GSM/UMTS modules are trying to log in is overloaded. Change the antenna position or reduce the count of the logged-in GSM/UMTS modules.
- One of the GSM/UMTS modules is permanently logged-out or fails to make outgoing calls:
 - The problem indicates a GSM/UMTS network overload on the installation site. To eliminate the problem, set the **Relax delay** parameter to **2 seconds**. If the GSM module fails to log in or rejects to make outgoing GSM calls even after the gateway restart, consult your GSM provider for your SIM card/GSM module availability.

The manufacturer shall not be held liable for any SIM card or provider service unavailability in the case of a breach of the provider's SIM terms and conditions for the SIM card use.

2.2 Brief Installation Guide

Installation Conditions

The following installation conditions have to be met for a proper installation:

- **2N[®] BRI Enterprise / BRI Lite** is to be installed on a site with enough free space.
- **2N[®] BRI Enterprise / BRI Lite** is to be mounted on a suitable vertical surface. For this purpose, a hanger is included in the gateway delivery, which is fitted to the wall using dowels and screws and used for gateway hanging.

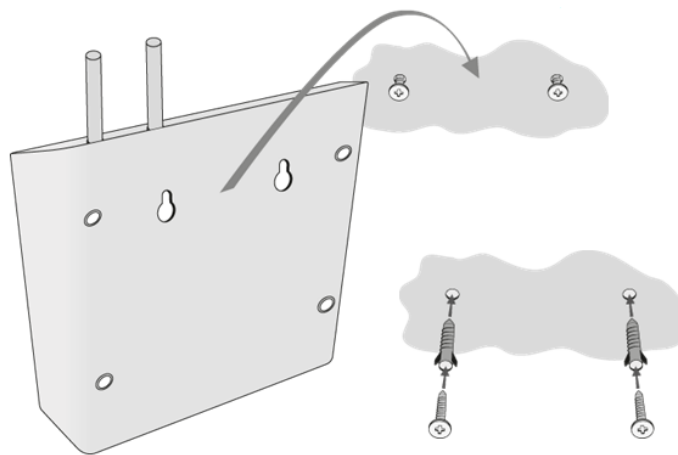

- It is possible to operate the gateway in another working position too, e.g. on a desk, for a short time for servicing and testing purposes, for example.
- Any excess of the allowed working temperature may not affect the **2N[®] BRI Enterprise / BRI Lite** function immediately but may result in faster ageing and lower reliability. For the allowed working temperature and humidity ranges refer to [S. 7](#).
- **2N[®] BRI Enterprise / BRI Lite** is not designed for high-vibration environments such as means of transport, machine rooms, and similar.
- **2N[®] BRI Enterprise / BRI Lite** is not designed for dusty environments or places exposed to high humidity and temperature changes.
- **2N[®] BRI Enterprise / BRI Lite** may not be exposed to aggressive gases, acid and solvent vapours (during cover cleaning, e.g.).
- **2N[®] BRI Enterprise / BRI Lite** is intended for indoor use. It may not be exposed to rain, flowing water, condensing moisture, fog, and so on.
- **2N[®] BRI Enterprise / BRI Lite** may never be exposed to direct sunshine or placed close to heat sources (radiators).
- A sufficient clearance must be kept over and under **2N[®] BRI Enterprise / BRI Lite** for cabling and air flow to carry off the heat.
- A sufficient GSM/UMTS signal intensity has to be provided for **2N[®] BRI Enterprise / BRI Lite**.
- An adequate capacity of the GSM/UMTS network has to be ensured (no BTS overload). Remember that multiple GSM gateways used in one location may overload the base transceiver station (BTS) you are currently logged in to. This may lead to a permanent or occasional rejection of GSM/UMTS calls!

- No strong electromagnetic radiation is allowed on the **2N[®] BRI Enterprise / BRI Lite** installation site.
- No strong electromagnetic reflections are allowed on the **2N[®] BRI Enterprise / BRI Lite** antenna installation site.
- An inappropriate location of **2N[®] BRI Enterprise / BRI Lite** or its antenna close to television, broadcasting and/or other rf-sensitive sets may impair the function of these sets.
- Being a source of radio frequency emissions, the **2N[®] BRI Enterprise / BRI Lite** antenna should not occur in the close vicinity of the human body. The health hazard is higher than with mobile phones as, generally, gateways shared by multiple users show a very high traffic.
- It is recommended that the power supply adapter should be connected to a network with a UPS back-up and due overvoltage protection.

SIM Card Inserting/Removing

Insert the SIM card in the **2N[®] BRI Enterprise / BRI Lite** bottom as shown in the figure. As the SIM slots are of the Push/Pull type, just slide the card in and push it into position. Push the SIM gently to slide it out of the slot.

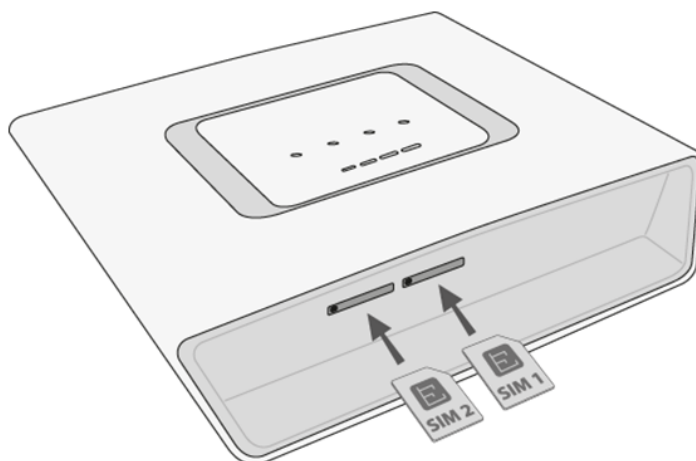

Caution

- Be sure to **set** such provider/SIM card services as call forwarding, call barring, preferred networks, SMS centre, etc. in your mobile phone **before inserting the SIM card** into **2N[®] BRI Enterprise / BRI Lite**.
- If two SIM cards are used, make sure that both the SIM cards have **one and the same PIN** or **PIN code request disable**.
- **Having inserted the SIM card, restart 2N[®] BRI Enterprise / BRI Lite** to make the SIM card log in.
- Remember to **disable** the **Another call on line** service before using the SIM cards!

Antenna Connection

2N® BRI Enterprise / BRI Lite is equipped with a SMA female antenna connector for all the GSM/UMTS modules. The external antenna should always be installed vertically on a site with a good wireless signal.

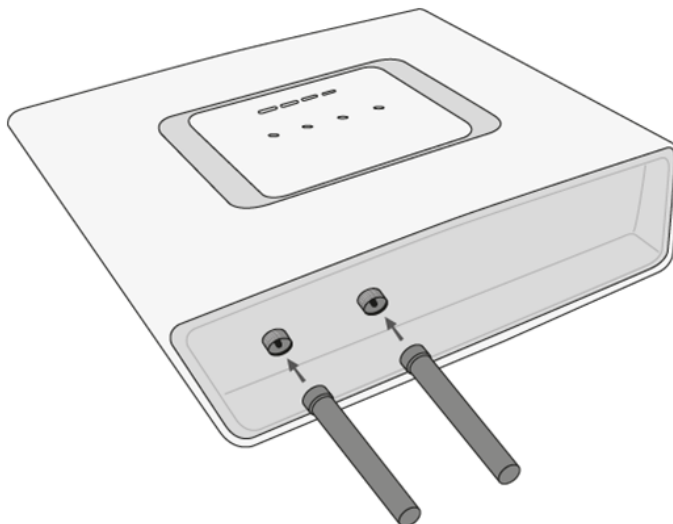

⚠ Warning

- Tighten the antenna connector gently with your hand – **never use a wrench!**
- Being a source of radio frequency emissions, the **2N® BRI Enterprise / BRI Lite** antenna should not be very close to the human body. The **health hazard** is higher than with mobile phones as, in general, gateways shared by multiple users show a very high traffic.

ℹ Note

- The antenna has a sufficient gain for a trouble-free operation under normal conditions. If the signal is poor or you want to place your antenna away from **2N® BRI Enterprise / BRI Lite**, you can use an antenna with an SMA-connector terminated cable. The antenna should be mounted vertically.
- Refer to [S.7](#), **Technical Parameters**, for the antenna parameters.

Power Supply Connection

Use only the power supply adapter included in the delivery. Make sure that the electric distribution network voltage is in compliance with the data on the supply adapter plate before plugging the adapter and that the antenna is connected properly. If you connect the power supply without having connected the antenna, the GSM module transmitter may get damaged. Plug the supply adapter into the mains socket and only then connect the adapter connector to the gateway. Refer to the status indicators.

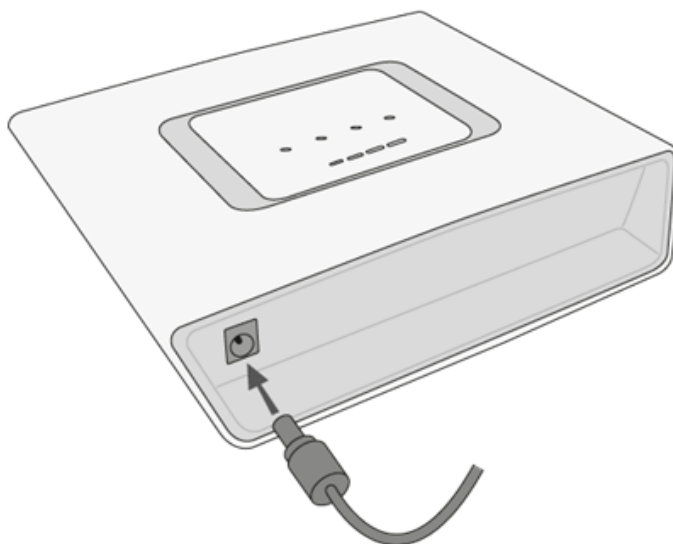

Warning

- Connecting a defective or inappropriate power supply adapter may lead to a temporary or permanent **2N[®] BRI Enterprise / BRI Lite** error!
- Check whether the antenna is connected before plugging the adapter. **Feeding the device without antenna connection may result in the GSM module transmitter damage.**

Ethernet Cable Connection

To connect **2N[®] BRI Enterprise/Lite** into the Ethernet network, use a standard straight cable terminated with RJ-45 connectors (included in the package). The GSM gateway supports the 10BaseT and 100BaseT standards, the Ethernet connection status is indicated by the status LED indicators located on the RJ-45 connector (refer to [S. 2.1](#) for details).

Caution

- The Ethernet interface is used for remote supervision and configuration only, i.e. does not contain the VoIP interface.
- With a proper licence, the device provides the VoIP-SIP support.

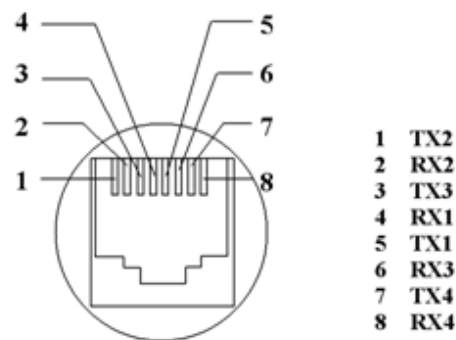
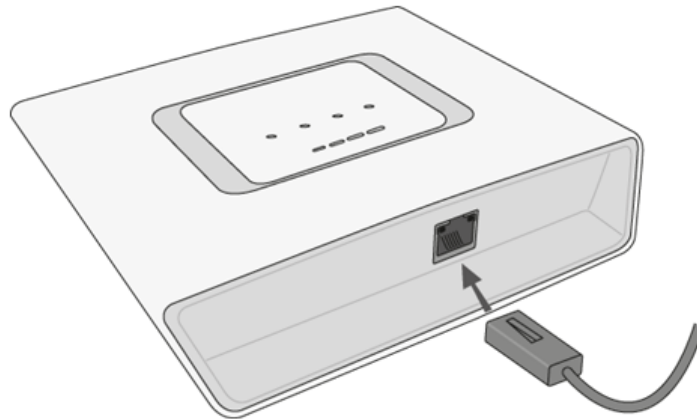

RJ-45 LAN Connector

NT and TE Connectors

ISDN devices are connected to the NT/TE connectors depending on the configuration of your telecommunications equipment. They are connected via a 4-wire passive bus with the aid of RJ-45 connectors. Refer to the figure below for the NT/TE connector pin lay-out.

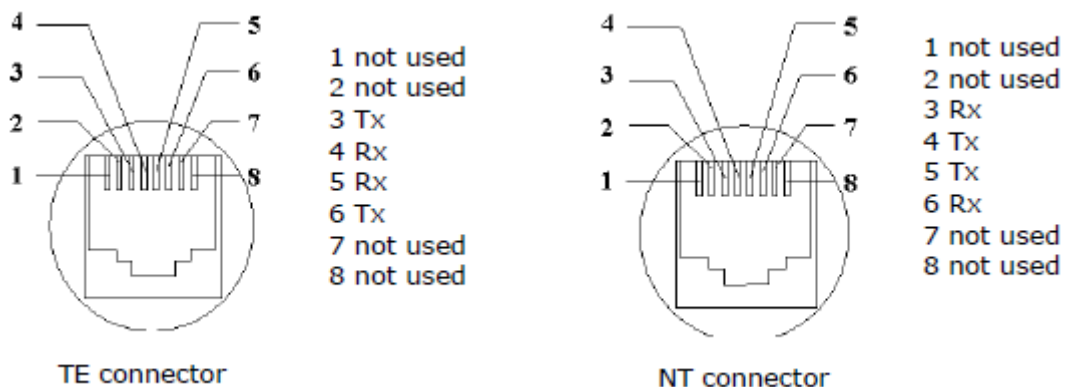

TE connector The figure below shows **2N[®] BRI Enterprise / BRI Lite** connected as network termination (NT) – extension for your ISDN PBX or ISDN phone, i.e. your own equipment.

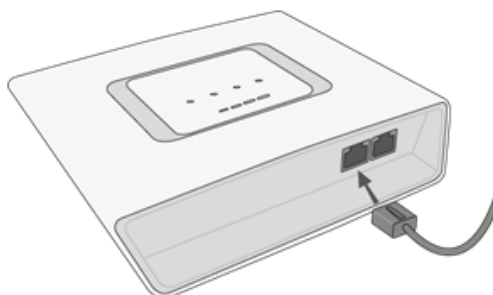

The figure below shows **2N[®] BRI Enterprise / BRI Lite** connected as terminal equipment (TE) – extension from the ISDN (PSTN), i.e. from your service provider.

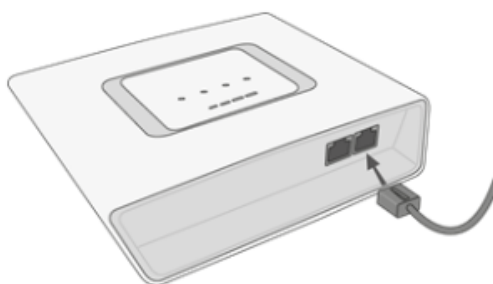

An example of the **2N[®] BRI Enterprise** connection in the ISDN mode follows.

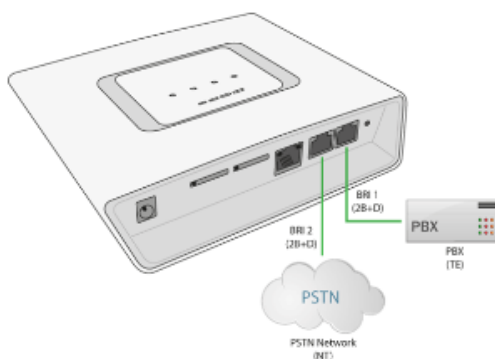

⚠ Caution

- **2N[®] BRI Lite** is equipped with just one ISDN BRI. Hence, two independent devices cannot be connected at the same time!

2.3 Available ISDN BRI Extension Configurations

You have to know the way of connection of your ISDN devices in order to configure your **2N[®] BRI Enterprise / BRI Lite** GSM gateway correctly. For information on your ISDN type, check your ISDN extension provider's registration form or contact your telephone network administrator.

Point-to-Point Configuration

The Point-to-Point (EuroISDN with DDI) configuration interconnects directly one ISDN terminal (TE) and a network terminal (NT) (see the figure below). This type is applied mainly where PBXs are connected to the ISDN.

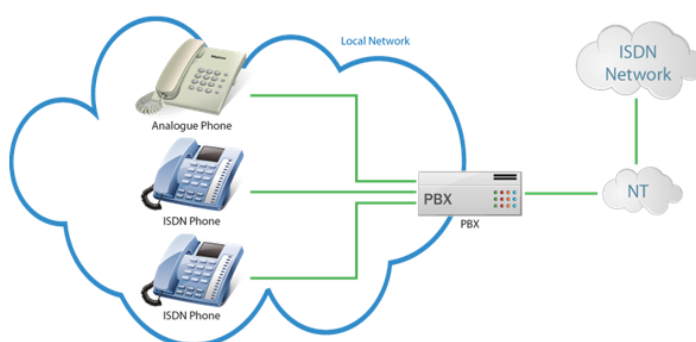

Point-to-Multipoint Configuration

Point-to-Multipoint (EuroISDN with MSN) is another type of ISDN terminal interconnection. Here the network terminal (NT) is interconnected with up to eight ISDN terminals through a 4-wire passive bus as shown in the figure below.

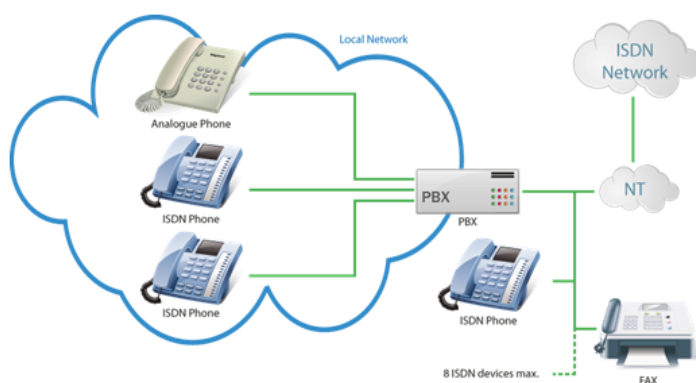

2.4 IP Voice Transmission

Speech Encoding Methods

Voice transmission is strictly separated from signalling in VoIP networks. Modern VoIP networks mostly use the RTP (Realtime Transport Protocol) for voice transmission. The purpose of the RTP is only to transmit data (voice) from a source to a destination at real time. Codecs are used to save the channel data capacity. Codecs process the voice signal using variable algorithms to minimise the volume of user data. The degree of compression used by the codec affects the quality of voice transmission. Thus, the better voice transmission is required, the wider data range (the higher transmission rate) is needed. The MOS (Mean Opinion Score) scale is used for rating voice transmission quality, where 1 means the worst and 5 the best quality. For a survey of the codecs supported by **2N® BRI** gateway refer to the table below.

Codecs supported			
Standard	Algorithm	Transmission rate [kbps]	MOS
G.711a	PCM	64	4.1
G.711u	PCM	64	4.1
G.729 G.729 is an optional part of the system.	CS-ACELP	8	3.92

For **2N® BRI** gateway, quadruple the above mentioned rates (two fully duplex calls) and add the TCP and IP header transmission rate to the result to get the resultant transmission rate.

It is important to keep both a stable appropriate transmission rate during connection and a small and identical transmission time per data packet in order to maintain a high-quality voice transmission.

- **G.711** – this codec is used in digital telephone networks. The PCM (Pulse Code Modulation) is used for voice signal encoding. The sampled signal is encoded in 12 bits and then compressed using a non-linear scheme into the resultant 8 bits. Europe uses the A-law compression system while North America and Japan obey the μ -law. The resultant data flow is 64 kbps.
- **G.729** – this codec uses the CS-ACELP (Conjugate-Structure Algebraic-Code-Excited Linear-Prediction) algorithm with the resultant transmission rate of 8 kbps. The speech signal is split into blocks of 10 ms each. The parameters of these blocks are then inserted in frames of the size of 10 bytes. 2-byte frames are generated for noise transmission.

During call set-up, a codec is selected automatically for voice transmission. **2N® BRI** gateway supports the codecs included in the table above. The type of codec to be used depends on your VoIP network (individual devices) and your **2N® BRI** gateway configuration. **2N® BRI** gateway is designed primarily for VoIP corporate networks and tries to meet the opponent's codec requirements. If a codec is requested that is incompatible with **2N® BRI Enterprise**, the call will be rejected.

The SIP and ITU-T H.323 recommended protocols are mostly used for connection establishing, maintaining and cancelling. **2N® BRI** gateway uses the **SIP** (Session Initiation Protocol) signalling.

 **Tip**

- In the case of separated direct connection of your SIP Proxy and **2N[®] VoiceBlue Next**, use the G.711 codec to achieve a high voice quality.

SIP Components

The following components are involved in the SIP message exchange:

- **UAC (User Agent Client)** – the terminal device client, which initiates SIP signalling.
- **UAS (User Agent Server)** – the terminal device server, which responds to SIP signalling from the UAC.
- **UA (User Agent)** – a SIP network terminal (SIP phones, gateways to other networks, etc.), which contains the UAC and UAS.
- **Proxy server** – receives connection requests from the UA and transfers them to the next Proxy server if the given station is not under its administration.
- **Redirect server** – receives connection requests, but, instead of sending them to the called line, sends them back to the requesting device asking for where to route the request.
- **Location server** – receives registration requests from the UA and updates the terminal database accordingly.

All the server components (Proxy, Redirect, Location) are mostly on one physical device called Proxy server, which is responsible for keeping a client database and connection establishing, maintaining and terminating, as well as call routing.

The **2N[®] BRI** gateway VoIP-GSM gateway acts as a UA in any case (has the same functions as a VoIP phone), i.e. receives call set-up requirements and, on the basis of its inner LCR table, routes calls to GSM networks.

None of the SIP-defined server components are integrated in the **2N[®] BRI** gateway gateway.

SIP Signalling Messages

Below is a list of messages sent via the SIP:

- **INVITE** – connection set-up request;
- **ACK** – INVITE confirmation by the final message addressee;
- **BYE** – connection termination;
- **CANCEL** – failed connection cancellation;
- **REGISTER** – UA registration with the SIP Proxy;
- **OPTIONS** – server capability query.

The answers to the SIP messages are numerically coded as the case is with the http protocol. Below are the most important ones:

- **1XX** – information messages (100 – trying, 180 – ringing, 183 – progress);
- **2XX** – successful request completion (200 – OK);
- **3XX** – request forwarding needed (302 – temporarily moved, 305 – use Proxy);
- **4XX** – error (403 – forbidden, 486 – busy here);
- **5XX** – server error (500 – Server Internal Error, 501 – not implemented);
- **6XX** – global failure (606 – not acceptable).

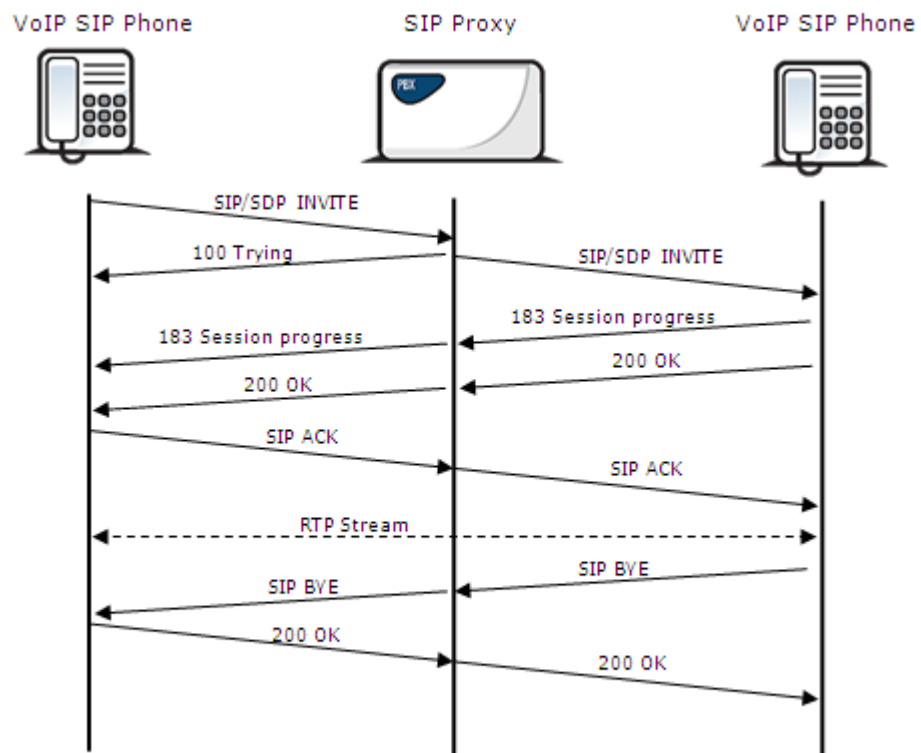

SIP Message Sending during Call Set-up and Cancellation

2.5 Types of 2N® BRI Enterprise Connection

This subsection deals with the types of connection of the **2N® BRI Enterprise** gateway to the main ISDN BRI extension.

ISDN TE – 2N® BRI Enterprise Connection

The connection type shown in the figure below provides communication via a GSM/UMTS gateway without PSTN connection. The ISDN telephone sets are connected to the NT port of the GSM gateway, while a mains adapter simulating power supply from the PSTN is connected to the TE port. The adapter is available under Part No. 5020002.

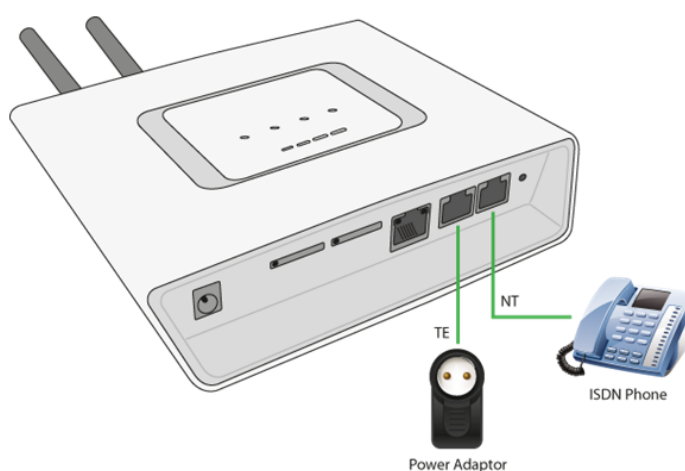

2N® BRI Enterprise Point-to-Point Connection

This type of connection is especially suitable for direct calls from an ISDN branch network to a GSM/UMTS network.

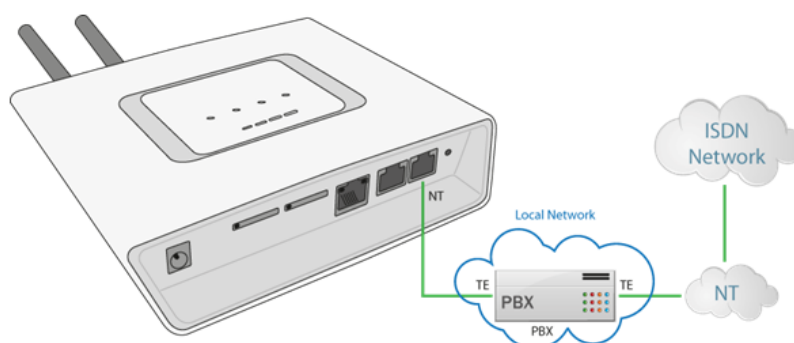

Another possible connection type is NT, where gateway synchronisation is derived from the PSTN BRI extension.

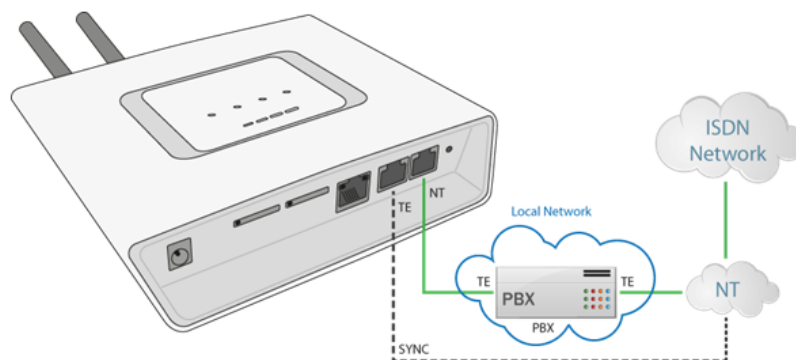

With multiple GSM gateways, the connection lay-out is as follows:

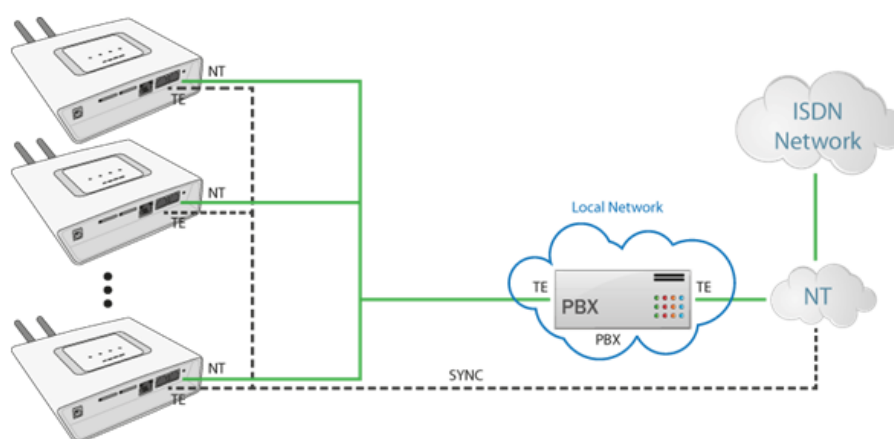

2N[®] BRI Enterprise Connection as DialThru Router

This type of connection saves one BRI port to the PBX. Incoming PSTN calls are treated by the GSM/UMTS gateway in the DialThru mode while outgoing calls are routed according to the LCR table.

The figure below shows the gateway as a DialThru router for the Point-to-Multipoint extension. Calls are routed automatically into GSM, UMTS or ISDN based on the internal LCR rules.

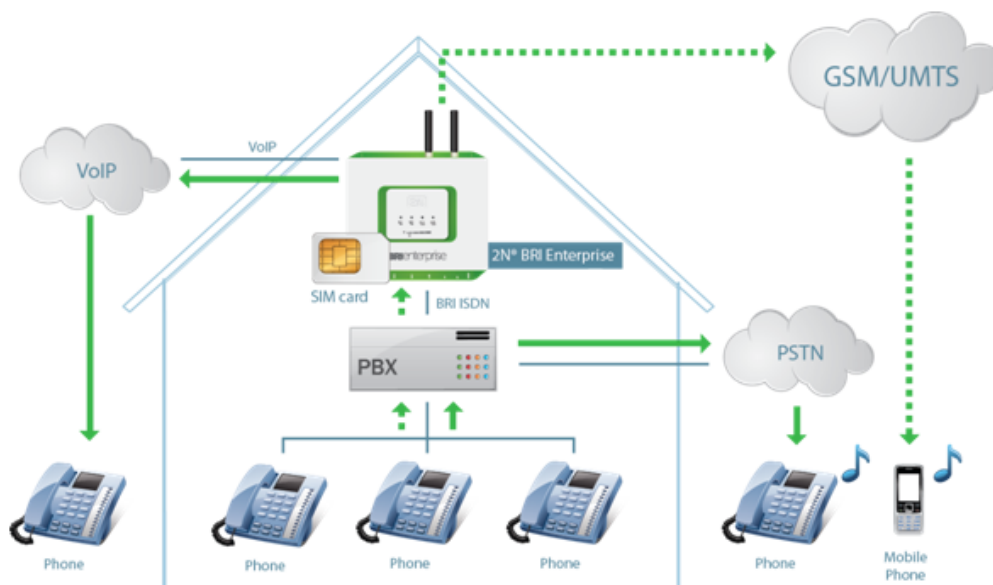

3. Making Calls via BRI Gateway

This section describes the call routing techniques via an ISDN BRI GSM gateway. The purpose of the settings is to improve your call efficiency and cut your call costs.

Here is what you can find in this section:

- [3.1 Supported 2N BRI Gateway Functions](#)
- [3.2 Call Routing Principles](#)

3.1 Supported 2N BRI Gateway Functions

- Time/destination based call routing
- B-channel based call routing
- Intelligent incoming CLIP routing (based on Calling Line Identification Presentation)
- Auto CLIP routing (automatic incoming call routing to a line stored in the AutoCLIP table)
- Time LCR (Least Cost Router) based outgoing call routing
- DISA (tone dialling)
- DISA into GSM (tone DID from ISDN ports to GSM networks)
- CallBacks to GSM
- SMS sending/receiving
- SMS at no answer
- Configuration via web interface
- Access password for configuration on all ports
- CLIP and CLIR for incoming GSM calls
- ENBLOCK/OVERLAP dialling transmission to ISDN
- Generation/retransmission from GSM of AoC pulses
- Table of allowed/barred numbers calling from GSM
- ISDN BRI monitoring with Alert SMS option
- Alive SMS in user defined intervals
- **2N[®] Mobility Extension** feature

3.2 Call Routing Principles

2N[®] BRI Lite

The gateway is equipped with one BRI ISDN and one VoIP-SIP ports. You can select one of the following incoming call processing modes for each of the ports via the web interface:

- **Use LCR table** – in this case, calls will be routed as set in the LCR table
- **Reject calls** – all incoming calls will be rejected
- **Route to port** – all calls will be routed to the selected port without change

If your BRI gateway is connected to a PBX subscriber line, you can activate DTMF. If you do so, the GSM gateway automatically answers any incoming call from BRI ISDN and offers the caller dialtone for another DTMF dialling. The call will then be routed to the GSM/UMTS modules.

Incoming GSM/UMTS calls can be either DTMF-processed or automatically routed to the ISDN BRI / VoIP-SIP interface according to the active intelligent GSM gateway rules functions (Auto CLIP, CLIP routing). They are routed to the ISDN NT or ISDN TE interface depending on the GSM gateway configuration.

Incoming GSM/UMTS calls can also be rejected and, with the aid of CLIP, used for CallBack.

The LCR algorithm routes outgoing calls on the basis of the call type, current time tariff, day in a week and, if available, free minutes of GSM providers.

2N[®] BRI Enterprise

The gateway is equipped with two BRI ISDN and one VoIP-SIP ports. You can select one of the following incoming call processing modes for each of the ISDN ports via the web interface

- **Use LCR table** – in this case, calls will be routed as set in the LCR table
- **Reject calls** – all incoming calls will be rejected
- **Route to port** – all calls will be routed to the selected port without change

If your BRI gateway is connected to a PBX subscriber line, you can activate DTMF. If you do so, the GSM gateway automatically answers any incoming call from BRI ISDN and offers the caller dialtone for another DTMF dialling. The call will then be routed to the GSM/UMTS modules.

Incoming GSM/UMTS calls can be either DTMF-processed or automatically routed to the ISDN BRI interface according to the active intelligent GSM gateway rules functions (Auto CLIP, CLIP routing). They are routed to the ISDN NT, or ISDN TE interface depending on the GSM gateway configuration.

Incoming GSM/UMTS calls can also be rejected and, with the aid of CLIP, used for CallBack.

The LCR algorithm routes outgoing calls on the basis of the call type, current time tariff, day in a week and, if necessary, free minutes of GSM providers.

✔ Tip

- **2N® BRI Enterprise / BRI Lite** can also route outgoing calls into the GSM/UMTS networks according to the B-channel used. In that case, the GSM/UMTS module is paired with a specific B-channel of the ISDN BRI line.

2N® Mobility Extension

2N® Mobility Extension (ME) is a function that turns your mobile phone into an SIP phone taking advantage of all the PBX functions. To make your **2N® Mobility Extension** work efficiently, use the **2N® BRI Lite/Enterprise** gateway to assign your mobile phone an account with the same SIP parameters (ID/user/password) that help connect your office SIP phone to the SIP Proxy server. After this account gets registered with the SIP Proxy server via **2N® BRI Lite/Enterprise**, your mobile phone will work as **2N® Mobility Extension** and make use of the services described below.

Advantages:

- You never miss any important call as you are available at all times.
- You can get information SMS messages on missed calls.
- You can control your company PBX call forwarding services from your mobile phone.
- You can make use of a comfortable DTMF code control.
- You need not make complicated forwarding actions as the function is fully automatic.
- ME can work with any SIP Proxy PBX.
- ME can replace any standard VoIP phone.
- Calls to your mobile phone are free of charge or at a moderate cost⁴.
- You need not integrate a costly DECT system any longer.

Model Situation

“Follow me” function

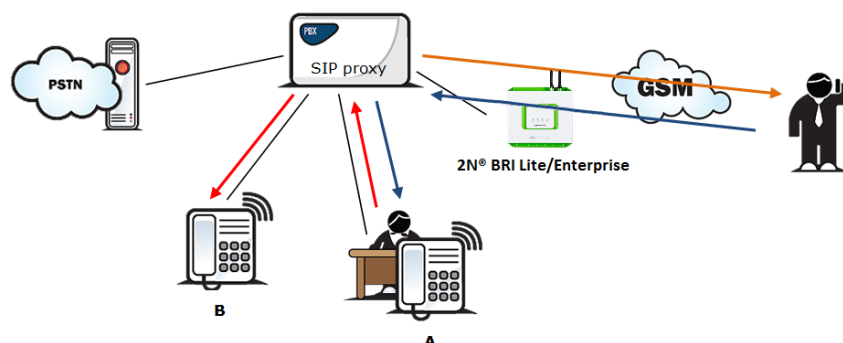

Figure 1: Follow Me Function

Fig. 1 shows routing of calls in the case of absence of a subscriber in the VoIP network. Subscriber A calls subscriber B, for whom the **2N[®] Mobility Extension** function has been permitted with the active "Follow me" function. Subscriber B does not answer the call in the VoIP network and so the call is rerouted to its mobile telephone.

"SMS at no answer" function

In the case of a missed call in the VoIP network, the **2N[®] Mobility Extension** provides sending of an information text announcement. This function is called "SMS at no answer". Like with call forwarding, it is possible to use the DTMF option to activate and deactivate the service of sending text announcements for missed calls.

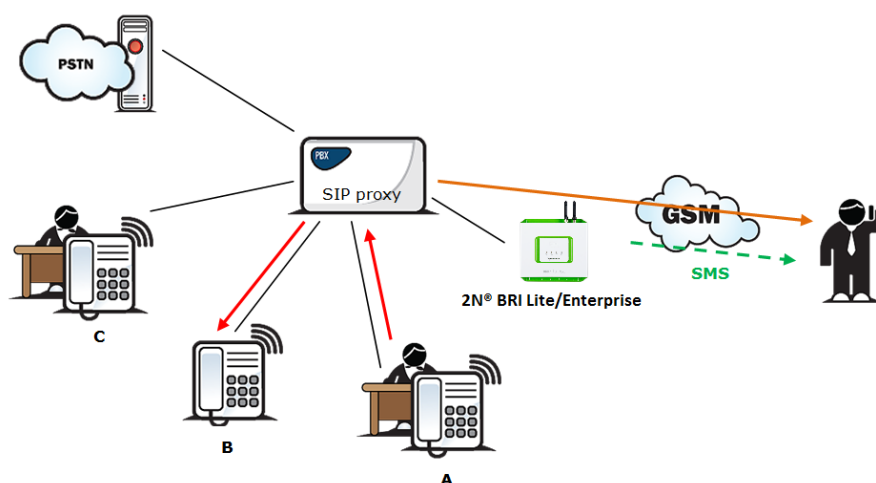

Figure 2: SMS at No Answer Function

Fig. 2 shows sending of information texts if an incoming call is not answered. Subscriber A calls subscriber B, for whom the **2N[®] Mobility Extension** has been permitted with activated "Follow me" and "SMS at no answer" services. Subscriber B does not answer the call in the VoIP network and so the call is rerouted to its mobile telephone. Subscriber B does not answer the mobile phone call and is sent a text announcing that the call from subscriber A has been missed.

"Call forwarding" function

In addition to rerouting calls in the event of absence, the **2N[®] Mobility Extension** allows calls to be forwarded within a VoIP network, which brings the services of the SIP Proxy to a mobile telephone. The description of this function is shown in Fig. 3.

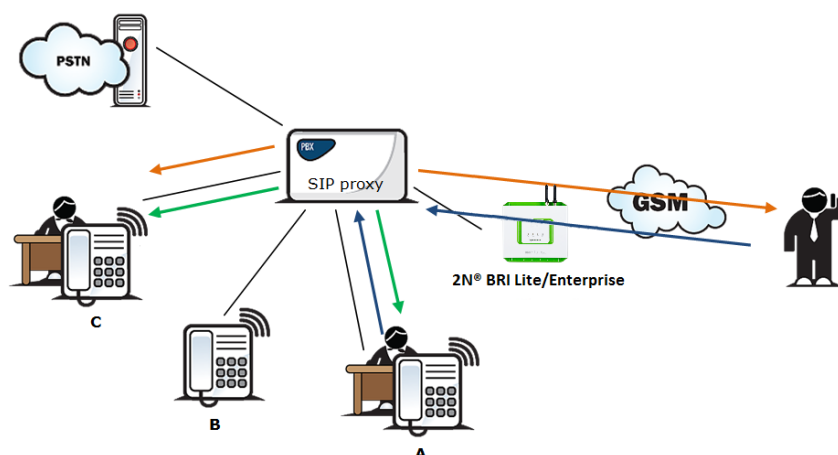

Figure 3: Call Forwarding Function

In Fig. 3 subscriber A is talking to subscriber B, for whom the **2N[®] Mobility Extension** has been permitted. Subscriber A would like to be forwarded to subscriber C. For this reason, subscriber B holds the call with A (7* in the default setting), dials the number of subscriber C, terminates dialling with the dialling end character (# in the default setting), notifies subscriber C of the call to be forwarded and hangs up to forward the call. If subscriber C does not want to talk to subscriber A, subscriber B terminates the call with C (9# in the default setting) and returns to the call with A.

"Quick call forwarding" function

In Fig. 4 subscriber A is talking to subscriber B, for whom the **2N[®] Mobility Extension** has been permitted. Subscriber A would like to be forwarded to subscriber C. Subscriber B wants to forward the call without having to talk to subscriber C. So subscriber B puts the call with A on hold (7* in the default setting), dials the quick forwarding character (default value #) and dials the telephone number of subscriber C, terminating the dialling with the dialling end character (default value #). Having received the dialling end character, **2N[®] BRI Lite/Enterprise** terminates the call between A and B and attempts to make a call between subscribers A and C. Subscriber A then receives the ring tone.

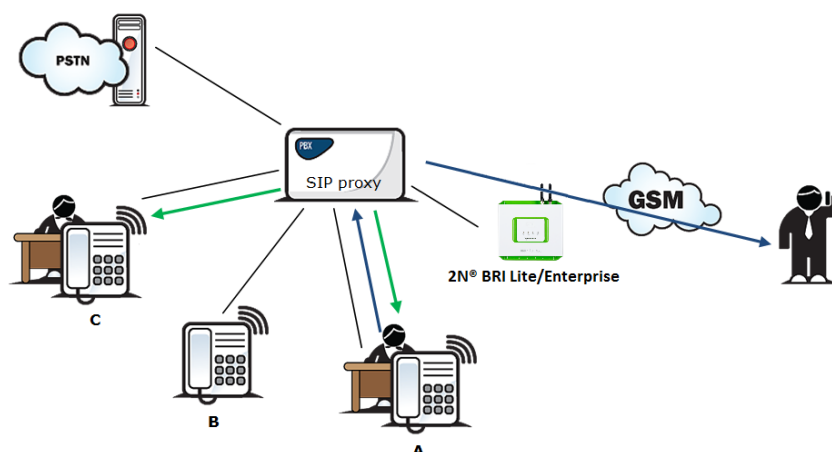

Figure 4: Quick Call Forwarding Function

Correct ME configuration

- Connect the GSM gateway to your PBX/SIP Proxy.
- Check whether the **2N[®] Mobility Extension** licence key has been entered correctly.
- Enter all ME users in the **Gateway configuration / Mobility Extension** menu.
- Enter the prefix matching the ME user mobile number in the **Gateway configuration / prefixes** menu.

LCR Table

The LCR (Least Cost Routing) table is the key telephone cost cutting tool. It helps you select call routes according to the called subscriber's number, daytime and weekdays. By adding bank holidays (with routing rules as on Sundays) to the LCR table you achieve even higher call cost savings.

To make your prefix and LCR routing work properly, enter the prefix of the number to be called to the GSM/UMTS network into the **Table of accepted prefixes** in the **Gateway configuration / Prefixes** menu. The number to be called may not exceed the **Default count of digits** or the higher priority **Count of digits** setting in the **Table of accepted prefixes**. The table is searched from top to bottom starting with the first match.

Apply the **Table of replaced prefixes** to modify the number to be called to the GSM/UMTS network. Every modification is displayed in the "**prefix**"/"**replace with**" format (99/+420, e.g.). The **Table of replaced prefixes** must always contain one record at least or the "/" record if no prefix modification is made. The digits removed from/added to the number in the **Table of replaced prefixes** are not included in the **Count of digits**. The table is searched from top to bottom starting with the first match.

GSM network ID is an optional parameter, which is assigned to each LCR record to make the LCR search more convenient. If this parameter is not completed, the list number is only used for identification (1-8).

i Poznámka

- **Count of digits** defines the minimum count of digits to be dialled. Hence, a call is successful if the count of the called number digits is equal to or higher than the value set in the **Count of digits**.
- The **Count of digits** does not include the digits removed from/added to the number in the Table of replaced prefixes.
- The **Count of digits** set in the Table of accepted prefixes has a higher priority than the **Default count of digits**.
- The **Table of replaced prefixes** must always contain one record at least or the "/" record if no prefix modification is made.

Make sure that the appropriate provider's SIM card is inserted in the GSM gateway. Assign the incoming and outgoing groups in the **Gateway configuration / GSM groups assignment** menu.

For a call setup, the LCR table is searched sequentially from top to bottom. Each LCR table row is assigned a **Prefixlist** in which the prefix match is searched for. If a match is found, the call will be routed according to the routing group parameters (**Groups** in the LCR table) as set in the **Gateway configuration / GSM outgoing groups** table. The call will be connected via the GSM module as assigned to the **GSM outgoing groups** in the **GSM groups assignment** table.

If the selected GSM/UMTS module is busy, the call is routed according to the next routing rule included in the **Groups** and defined by the **GSM outgoing groups** table. Again, the **GSM outgoing group** is assigned to a GSM module in the **GSM groups assignment** table.

The LCR row is checked in this way until a free GSM/UMTS module is found. If no available GSM/UMTS module (**GSM outgoing groups**) is found, the call is rejected.

Outgoing GSM Call Routing from Internal ISDN

If the GSM/UMTS gateway is connected to a subscriber line of your PBX, you are advised to enable the DISA function to GSM to make your GSM gateway answer every call routed to it by the PBX and wait for further dialling to GSM networks.

The GSM/UMTS gateway routes outgoing calls to GSM as follows:

- The calling subscriber dials a user number.
- If the user dialling is evaluated as **Access to GSM gateway**, the gateway barred number table is searched through and, if a match is found, the call setup request is rejected.
- With an outgoing call, the gateway waits for further digits to be dialled. This timeout results in a certain delay between the subscriber's dialling and the subsequent dialling by the GSM gateway. Therefore, select the **Count of dialled digits** for the called destinations while configuring your gateway. Then, the gateway initiates the outgoing call processing algorithm on receiving the last digit.
- The dialling prefix is first checked against the prefixes included in the first row of the LCR table. If no match is found, the following row is used for check and so on.
- In case the prefix and call time comply with the routing rules, the call is routed according to the first LCR rule to the module corresponding to the particular **Outgoing GSM group** included in the **Groups** list.

- If the selected GSM module is busy or has a low credit, the preceding step is repeated and the next LCR row is checked.
- In case the selected GSM module is free and has a sufficiently high credit, the GSM gateway starts dialling the GSM number.
- If the calling subscriber number has an unknown prefix or all routes are busy, the GSM gateway rejects the call setup request.
- An outgoing call is not billed until the called party answers the call.
- The GSM network signals the off-hook and the GSM gateway transfers this information to the PBX.
- The gateway is able to generate the AoC tariff pulses during an outgoing call, which, if the GSM gateway is connected to the PBX, allows for call cost logging per user.

Incoming GSM Call Routing

Incoming GSM calls are routed by the algorithm described in the following steps.

Incoming calls are processed according to the **Mode** parameter in the **Incoming GSM calls** table. The following options are available:

- **Reject/Ignore incoming calls** – incoming calls are not routed to extensions. The call setup request can either be rejected or ignored on the GSM side (the calling party hears the check ringing tone).
- **Report to PC** – information on an incoming call is sent to a PC equipped with the management software. The calling subscriber gets a voice message or the check ringing tone. The management software then completes the call routing procedure.
- **CallBack** – this function helps establish connection on the account of the SIM card inserted in the gateway. The incoming call is either ignored or rejected. After the calling subscriber hangs up, the GSM gateway sets up connection to the defined extension. When the extension answers, the GSM gateway replays the CallBack message to the extension while establishing connection to the previously calling GSM/UMTS subscriber. After the CallBack message, the GSM gateway interconnects the call. If CallBack with incoming call ignoring is enabled and the calling party fails to hang up within a defined timeout (default=10s), the CallBack function is disabled for this call and the subscriber can go on dialling the extension number. Set the CallBack function in the CLIP routing table.
- If none of the above mentioned options is selected, the AutoCLIP routing table is checked. If the calling number is found, the call is routed to the extension whose number is assigned to the calling number in the table.
- In case the calling number is not included in the AutoCLIP routing table, or the AutoCLIP routing function is disabled, the gateway receives the incoming call and either replays a voice message or transmits the dialtone to the calling subscriber. Then the gateway awaits the count of digits necessary for call setup. Define the minimum and maximum counts of DTMF digits in the **Incoming GSM calls** menu.
- If the gateway does not receive the minimum count of digits and no other digit comes from the GSM network within the timeout defined in the **DTMF dialling delay**, the call is rerouted to the extension included in the **List of called numbers**.
- If call forwarding to extension is inactive, the incoming call is rejected.

DISA Message

With DISA activated and DISA welcome note recorded, the message is played to every incoming call whose CLIP is not included in the AutoCLIP table. After playing, the gateway waits for the first DTMF digit for the time period defined in the **Incoming GSM calls – DTMF dial timeout** table. Having received the count of digits defined in the **Incoming GSM calls – Minimum DTMF digits** parameter, the gateway activates connection to the SIP proxy or telephone via the port included in the **ISDN parameters** table with the **DTMF – received number**. You can upload the DISA message using the GSM gateway web interface.

Or, you can record the message using your PC as disa.wav and load it into the gateway using the configuration program via the web interface.

DISA Recording via PC and Web Interface

The DISA voice message parameters for PC recording are as listed below: maximum duration of 65s, compression according to ISDN A-law, mono, sampling frequency of 8kHz. Name the file Disa.wav and load it via the **Gateway control / Voice messages** web interface into the gateway.

DISA voice message parameters:

- **Sound format:** WAV
- **Sampling frequency:** 8 kHz
- **Channels:** 1 mono
- **Codec:** ISDN A-law

4. First Launch

Having completed the physical installation, get acquainted with the factory settings and operation of the **2N® BRI Enterprise / BRI Lite** gateway.

Here is what you can find in this section:

- [4.1 Ethernet Interface](#)
- [4.2 Licence](#)
- [4.3 Firmware Version](#)
- [4.4 Factory Reset](#)
- [4.5 Basic Configuration – Step by Step](#)

4.1 Ethernet Interface

The BRI gateway can be fully configured via the web interface at http://IP_gateway_address. Make sure that a device equipped with a web browser (PC, NB, Tablet, etc.) has been connected for successful connection to the BRI gateway configuration interface. The device also supports configuration via an extended AT command set on the Telnet interface (IP port 23).

 **Tip**

- The device also supports configuration via an extended AT command set on the Telnet interface (IP port 23). Refer to [Subs. 6](#), page for details.

The BRI gateway supports DHCP (client). By default, the DHCP support is disabled.

 **Tip**

- If DHCP is active, use specialised detection software (for LANs only) to identify the assigned IP address. Refer to the www.2n.cz web sites, BRI Gateways (IP Scanner) for the software.

Use the web configuration interface in the Gateway configuration – Ethernet configuration section to set the Ethernet interface.

Ethernet Interface Factory Settings

IPv4 address	192.168.1.2
IP mask	255.255.255.0
Gateway	192.168.1.1
User name	Admin
User password	2n

 **Caution**

- **Change** the user name and password during your **first** gateway configuration to avoid unauthorised access to your gateway configuration! Refer to page for details!

 **Tip**

- In the event of data loss or configuration interface unavailability, perform the factory reset to retrieve the data. Doing so, however, you reset all the default values in your gateway. Refer to [Subs. 4.4](#), p. for details.

MAC Address

The BRI gateway has a unique, factory-set MAC (Media Access Control) address. Refer to the rear side label of your device or the gateway web interface for the MAC address.

Ethernet

MAC address:

7C-1E-B3-00-7B-7C

The MAC address can be user-changed.

✔ Tip

- If you use DHCP, you are advised to set permanent assignment of one and the same IPv4 address to the defined MAC address to avoid unexpected change of the gateway IPv4 address and subsequent VoIP-SIP setting errors.

4.2 Licence

The BRI gateway can contain different licence keys depending on the Part No. Refer to the Gateway control – Firmware/Licence section via the web interface for the current licence key status.

Information for gateway licence	
Serial number:	M203-5405540001
Active:	DSS1 G729 SIP TUN ME8
Gateway limitation:	688 hours (no limit)
Licence status:	Unlocked
Networks:	(all)

Use this section to download a new licence key into your gateway in order to change the current software licence status.

Gateway licence change	
	Warning: It will cause gateway restart!
Licence key for gateway:	<input type="text"/>

Caution

- The **2N® BRI Enterprise / BRI Lite** gateway can contain time-limited software licences (for SIP signalling, Mobility Extension, etc.). Such licences are limited to a certain period of time (hours) during which the gateway provides its services. Every GSM gateway restart adds one hour to the internal licence counter value!
- A **2N® BRI** gateway with an expired licence processes no incoming or outgoing calls! Ask your dealer for licence term prolongation or an unlimited licence in due time.

Restricted Use in GSM / UMTS Networks

Some types of BRI gateways may be locked for use in specified GSM/UMTS networks only. This means that you will not be able to use such gateways in networks other than the recommended GSM/UMTS networks. This state is signalled by a red LED in the given GSM/UMTS module and a 'netw-err' cause in the diagnostics. Contact your dealer please for more information.

Tip

- Contact your dealer please for more information.

4.3 Firmware Version

Upgrade your **2N® BRI Enterprise / BRI Lite** gateway with the latest firmware version available for this GSM gateway type before installation. Refer to www.2n.cz for the latest firmware version.

⚠ Warning

- Use the **firmware certified** for this GSM gateway type only to avoid **irreversible damage** to your system!

Download the new firmware version comfortably using the gateway configuration interface as follows:

- Connect the PC and gateway to the Ethernet.
- Open the web browser (MS Internet Explorer 9 and higher or Mozilla Firefox v. 4 and higher are recommended).
- Log in to the GSM gateway web interface by entering http://IP_gateway_address
- Click on **Management / Firmware update**, then on **Browse** and select the new firmware file.
- Click on the **Download firmware** icon in the bottom part of the web site.

The BRI gateway will perform upgrade automatically.

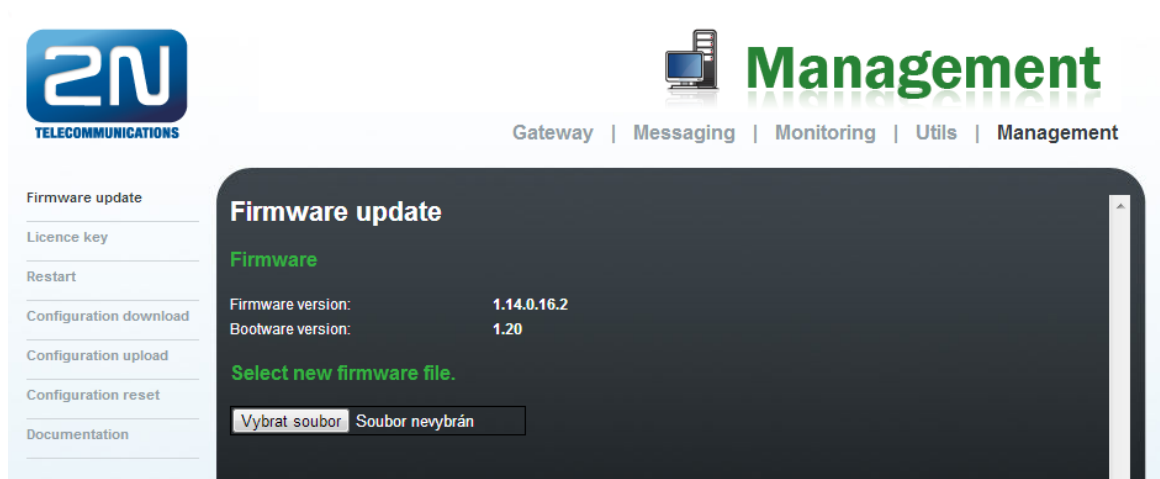

4.4 Factory Reset

Should you forget your password or set the IP interface incorrectly, you can reset the factory values. Press the **Reset** button right to the BRI ISDN connector for a rather long time to reset the default values.

Doing so, you reset all the factory configuration values for all the parameters including those related to the Ethernet interface and access data.

Caution

- By resetting the default configuration values, you change the Ethernet interface settings and have to reconfigure the gateway subsequently.



Note

- To reset the factory values, press the Reset button until the LED indicators start flashing red.

Note

- Press the **Reset** button for a short time (0.5 s) to restart the GSM gateway.

4.5 Basic Configuration – Step by Step

This subsection helps you put your BRI gateway in operation for the first time. Refer to the paragraphs of [S. 3](#) for more detailed settings.

- Install the GSM gateway as instructed in [Subs. 2.2](#). Remove the SIM cards or insert the PIN-disabled SIM cards before the first launch.
- Connect the GSM gateway to the Ethernet to be able to get connected to the address mentioned in [Subs. 4.1](#), page from the web interface. If the default IP address of your gateway is not suitable for your Ethernet installation, change the IP address setting as follows:
 - Disconnect the configuration terminal from the Ethernet.
 - Disconnect the GSM gateway from the Ethernet.
 - Get an Ethernet switch or an Ethernet crossed cable.
 - With the crossed cable, interconnect the configuration terminal directly with the GSM gateway.
 - With the Ethernet switch, connect the configuration terminal and GSM gateway to the switch. We do not recommend you to connect any other device.
 - Change the IPv4 setting in your configuration terminal Ethernet settings to, e.g.: IP=192.168.1.200, Net mask: 255.255.255.0
 - Open your web browser and enter the IP address of your GSM gateway.
 - Complete the factory login data.
 - Change the required settings in the Gateway configuration – Ethernet configuration section and save the changes into the GSM gateway.
 - Connect the GSM gateway to a standard Ethernet.
 - Rechange the IP settings of the configuration terminal and reconnect the terminal to a standard Ethernet.
- Enter the new IP address of your GSM gateway to get connected to the web interface.
- Set the current time and date for the GSM gateway in the Gateway control – Date/Time menu.
- Check the **Licence status** for 'unlocked' in the Gateway control – Firmware/Licence menu. If the status is not unlocked, your GSM gateway is not equipped with the proper licence (refer to [Subs 4.2](#)). Contact your dealer for the licence key.
- Set the correct PIN code value in the Gateway configuration – System parameters menu to meet the PIN code of the SIM cards used.
- Set new login data in the Gateway configuration – Login configuration menu.
- Switch off the GSM gateway and insert the SIM cards. Connect the antenna to the GSM gateway and switch the gateway on.
- The GSM gateway factory configuration allows you to make outgoing calls without any additional programming. All you have to do is set the correct values for the BRI ISDN and VoIP interfaces.

Should you have problems with the gateway functions, follows the instructions below please:

- Read the User Manual carefully and check all the parameters.
- Find answers to your questions at <http://faq.2n.cz> (Frequently Asked Questions).
- Contact your servicing centre.

It is recommended that you should attend certified training courses at 2N to be able to install the whole system successfully.

5. Introduction to Configuration Interface

This section introduces the configuration interface of the **2N[®] BRI Enterprise / BRI Lite** product.

Here is what you can find in this section:

- [5.1 Configuration Web Interface](#)
 - [Gateway Control](#)
 - [Gateway Configuration](#)
 - [Messaging](#)
 - [SMTP/POP3 Basic Configuration – Step by Step](#)
 - [SMPP Basic Configuration – Step by Step](#)
 - [Monitoring](#)
 - [List of SNMP traps](#)
 - [Utils](#)
 - [Management](#)
 - [Others](#)

5.1 Configuration Web Interface

Essential Data

The **2N[®] BRI Enterprise / BRI Lite** web interface supports the following web browsers:

- MS Internet Explorer v9
- Mozilla Firefox v4 and higher

Any other web browsers may cause troubles. The recommended screen resolution is 1280x1024 and colour quality 32bit and higher. The configuration interface is available in the English language version only at present.



Tip

- Use the F11 key to display the full-screen mode.

Login

Enter the server IP address into your web browser to log in to the web configuration interface of your BRI gateway. The following login dialogue will get displayed.

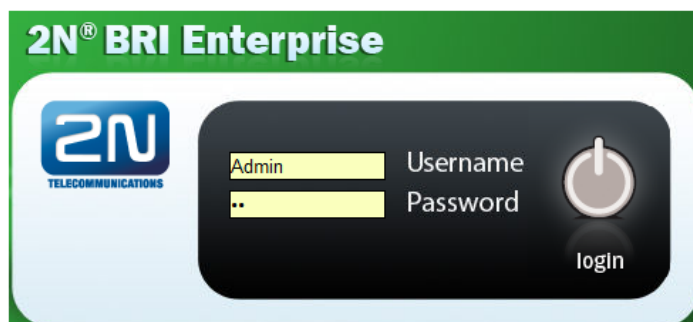

Just one user may be logged in at one time. Refer to [Subs. 4.1](#), page for access data default values.



Tip

- The one-user limitation applies to the web interface access only. If Telnet is used, ten users may be logged in at the same time.







Auto logout in 297 seconds (Refresh)

A five-minute⁴ time limit is defined for login, which is renewed automatically when the user keeps active on the web interface. When this time interval expires, the user is logged out automatically. Click on **Refresh** to restore the maximum time limit.

Caution

- You are recommended to change these default login data upon the first login to increase security of your system significantly.

Web Icons

Icon	Meaning
	Download factory default values
	Save current configuration into GSM gateway
	Reset default values in GSM gateway configuration
	Save to local disk of connected terminal
	Refresh displayed data
	Confirm action (configuration file download, e.g.)

Caution

- Remember to press the **Save settings** button to save the changes in order to avoid **loss** of new data after leaving the current configuration window!

[4]Set the time limit value in the Gateway – Web configuration – Auto logout section.

Home Page

Upon login, you get onto the home page (see the figure below) of the Gateway section. There is a menu to the left, divided into the **Gateway control** and **Gateway configuration** items. You can see the current login time counter status and the **Refresh** button for time limit refreshing in the right-hand upper corner. The **Logout** button on the home page is used for user logout. You will be notified of every successful logout to avoid reuse of your login data. The following sections are located in the upper menu too:

- **SIM client** – for connection to the **2N® SIM Star** system.
- **SMS** – for receiving/sending SMS via the web interface.
- **Messaging** – for receiving/sending SMS via SMPP or SMTP/POP3
- **Monitoring** – for gateway monitoring via SNMP
- **Utils** – including extending system tools (Network capture, Report capture).
- **Management** – for firmware update, license upload and configuration upload/download.

The main window also provides information on the gateway licence status, firmware and bootware versions and BRI gateway Ethernet interface MAC address. You can download a new licence here too.

The screenshot displays the '2N® BRI Enterprise Gateway' web interface. The main content area is titled 'Firmware/Licence' and contains the following information:

Firmware	
Firmware version:	1.17.0.20.3
Bootware version:	1.20

Ethernet	
MAC address:	7C-1E-B3-00-88-21

Information for gateway licence	
Serial number:	M203-5406030017
Active:	DSS1 MONI G729 SIP TUN ME8 SMSU32 SMSS SMSE SMSW SNMP
Gateway limitation:	1138 hours (no limit)
Licence status:	Unlocked
Auto licence:	Yes
Networks:	(all)

The interface also features a sidebar with navigation options like 'Gateway control', 'Gateway configuration', and 'Logout'. The top navigation bar includes 'EN', 'CZ', and 'ES' language options.

Gateway Control

Gateway control helps you:

- Monitor the current state of each GSM gateway parts;
- Check and set the GSM gateway licence;
- View and save the LOG file and CDR.

Firmware / Licence

Use this window to display information on the gateway licence status, firmware and bootware versions and Ethernet interface MAC address. Use the web interface to download a new licence via **Management / Licence**.

- **Firmware version** – displays the current firmware version for the GSM gateway connected.
- **Bootware version** – displays the current bootware version for the GSM gateway connected.
- **MAC address** – shows the MAC address of the GSM gateway Ethernet interface.
- **CPU serial number** – shows the GSM gateway serial number in the M203-xxxxxxxxxx.bin format.
- **Active** – protocols allowed by the licence:
 - **SIP** – SIP support;
 - **MExx** – Mobility Extension support, where 'xx' means the maximum count of users;
 - **G729** – G.729ab voice codec support;
 - **DSS1** – ISDN BRI DSS1 protocol support;
 - **TUN** – GSM-CSD remote supervision support.
 - **SMSU** – count of SMS users.
 - **SMSS** – SMPP support.
 - **SMSE** – SMS@email support.
 - **SMSW** – SMS via web support.
 - **SNMP** – SNMP monitoring support.
- **Gateway limitation** – displays the gateway operation limit (or licence limitation).
- **Licence status** – displays the current licence status (unlocked/locked).

Caution

- When the licence code expires, the licence-based protocols will be locked!

- **Networks** – displays the list of allowed/disallowed GSM/UMTS networks.

Tip

- Upon the dealer's request, the gateway may be locked against certain types of GSM/UMTS networks. This state is signalled by a red LED Ch 1/Ch 2 and a 'netw-err' cause in the GSM module diagnostic window. Contact your dealer please for more information.

- **Licence key for gateway** – helps you insert a new GSM gateway connection licence.

Caution

- By inserting a new licence code you restart the GSM gateway and discontinue all the currently made calls!

Date / Time

Use this window to set the current date and time for your gateway. Tick **Synchronise with local PC** to set the time a date items automatically according to your PC data.

Date/Time

Synchronise with local PC:

Time: 17 : 25 : 04

Date: 1 . 5 . 2012 . Tuesday

Caution

- The internal power source keeps the internal clock source running for a few hours only! Therefore, check the current gateway date and time after long BRI gateway disconnection!

Voice Messages

This window is used for recording, checking and downloading voice messages. Supported format is PCM–Alaw, Mono, 8000 Hz, 8 bits.

Index	Type of message	Use	Max. length(s)
0	DISA message	Inc. calls from GSM/UMTS	64
1	ME"Hallo"	Mobility Extension calls	4
2	ME"Mobility extension"	Mobility Extension calls	4
3	ME"Please dial number"	Mobility Extension calls	4
4	ME"Text message"	Mobility Extension calls	4
5	ME"Activated"	Mobility Extension calls	4
6	ME"Deactivated"	Mobility Extension calls	4
7	ME"beep"	Mobility Extension calls	4
8	ME"be,be,be"	Mobility Extension calls	4
21	GSM outgoing group 1	Calls via Out. GSM group 1	8
22	GSM outgoing group 2	Calls via Out. GSM group 2	8
23	GSM outgoing group 3	Calls via Out. GSM group 3	8
24	GSM outgoing group 4	Calls via Out. GSM group 4	8
25	GSM outgoing group 5	Calls via Out. GSM group 5	8
26	GSM outgoing group 6	Calls via Out. GSM group 6	8
27	GSM outgoing group 7	Calls via Out. GSM group 7	8
28	GSM outgoing group 8	Calls via Out. GSM group 8	8
30	Message 30	Voice message detector	8
31	Message 31	Voice message detector	8
32	Message 32	Voice message detector	8
33	Message 33	Voice message detector	8
34	Message 34	Voice message detector	8
35	Message 35	Voice message detector	8
36	Message 36	Voice message detector	8
37	Message 37	Voice message detector	8

You can choose which message will be uploaded or use detection by file name. Detection requires file name: "mess[index of message][optional remark].wav". You can upload more than one message in .tar file.

Note

- Voice messages with indexes 30 – 37 are used for detection of the mobile provider's voice message played before call connection. If a match is found of the voice message with any of the voice messages recorded in the gateway, the call is terminated automatically or established via the last GSM outgoing group set in the LCR table (on condition that the ITD – Ignore tone detection in last group parameter is active) in the **Gateway Configuration / LCR table** section. Refer to the **Gateway Configuration / GSM basic parameters / Voice message detector settings** for details.

LOG file

The LOG file helps you read out the gateway LOG file. There are LOG file saving and LOG listing updating icons in the lower part of the window.

date	time	event	text
** 5.01.00/19:01:23	POWER	[Warm boot]	
** 5.01.00/18:40:17	POWER	[Warm boot]	
** 2.01.00/19:11:26	POWER	[Warm boot]	
** 2.01.00/01:12:27	POWER	[Warm boot]	
** 2.01.00/01:12:19	BRDRES	SYSTEM RESET CMD	
** 2.01.00/01:10:03	POWER	[Warm boot]	
** 1.01.00/00:00:00	POWER	[Warm boot]	
** 1.01.00/00:00:00	INIT	Clock has been lost	

Refer to [Subs.7](#), page for details on LOG records.

CDR File

The CDR file window helps read out the Call Data Records (CDR) of the gateway. The bottom part of the window includes icons for saving the CDR into a file and refreshing the CDR listing in the web window. Refer to Subs. CDR line description for more details on the CDR format.

Caution

- The maximum capacity is 100,000 call records. When this limit is reached, the oldest record(s) will be deleted automatically!
- The latest 1,000 call records are displayed in the web interface.
- Downloading of a high amount of CDR may take up to several tens of seconds.

SDR File

The SDR file window helps read out the SMS Data Records (SDR) of the gateway. The bottom part of the window includes icons for saving the SDR into a file and refreshing the SDR listing in the web window. Refer to Subs. SDR line description for more details on the SDR format.

Caution

- The maximum capacity is 100,000 SMS records. When this limit is reached, the oldest record(s) will be deleted automatically!
- The latest 1,000 SMS records are displayed in the web interface.
- Downloading of a high amount of SDR may take up to several tens of seconds.

Module status

The window displays the current status of each GSM/UMTS channel. Refer to [Subs. 6.4](#), page for more details.

Module control

The window helps you control the selected GSM/UMTS module manually.

Statistics

The window displays the current statistic data on calls. There are LOG file saving and LOG listing updating icons in the lower part of the window. Refer to [Subs. 6.7](#), page for the statistic data format details.

Current call info

The window displays the currently made calls. There are LOG file saving and listing updating icons in the lower part of the window.

Connection state

The window shows the state of all available configuration sessions. There are LOG file saving and listing updating icons in the lower part of the window.

AutoCLIP routing table

The window displays the current state of the AutoCLIP table. There are LOG file saving and listing updating icons in the lower part of the window.

Note

- The maximum AutoCLIP routing table capacity is 256 records.

SIP registration

The window displays the current state of the gateway SIP registration.

ISDN lines

The window shows the state of each ISDN BRI interface of the gateway.

Online report

The window provides online GSM gateway tracing.

Gateway Configuration

System Parameters

General

- **Saving call data (CDR)** – define the call types for which the GSM gateway shall store information in the CDR.
- **Gateway ID** – provides **2N® BRI** gateway with a numerical code in the CDR in case multiple devices generate CDRs in the network.
- Number for remote control.

System Restart

- **Enable system restart** – enable/disable the feature.
- **Time of system restart [hh:mm]** – set the time for system restart.

Note

- If there are active calls, restart will be executed 10 seconds after the end of the last call.

Mobility Extension (DTMF settings)

- **Start dialling (quick call forwarding)** – set the DTMF code for quick call forwarding start.
- **End dialling (quick call forwarding)** – set the DTMF code for quick call forwarding end.
- **Hold call** – set the DTMF code for the current call holding.
- **Hang up call** – set the DTMF code for the current call termination.
- **'Follow me' activation** – activate the **Follow me** function to make the GSM gateway start routing calls to the defined GSM/UMTS user number. The default value is *55.
- **'Follow me' deactivation** – deactivate the **Follow me** function. The default value is #55.
- **'SMS at no answer' activation** – activate the **SMS at no answer** function for a registered user. The default value is *33.
- **'SMS at no answer' deactivation** – deactivate the **SMS at no answer** function for a registered user. The default value is #33.

Tip

- Activate/deactivate the **SMS at no answer** and **Follow me** functions by dialling the above mentioned DTMF access codes into the GSM gateway from a registered mobile user number. You can change the function values via the configuration interface too (see below).

Others

- **PIN** – set the PIN code for the PIN-secured SIM cards.

Caution

- A PIN-active SIM card with a PIN value other than that set in the GSM gateway configuration will be blocked by the gateway with the 'pin-err' cause. Enter the correct PIN on your mobile phone to unlock the SIM card!

- **End of dialling (empty=off)** – set the DTMF code for DTMF dialling end for DISA incoming calls. The default value is „#”.

List of emergency numbers

The window displays a list of emergency numbers, which are normally routed to the BRI interface. If the BRI line is disconnected, the emergency numbers are dialled automatically via any GSM/UMTS module according to the following rules:

- Search of a logged-in GSM/UMTS module (regardless of free minutes);
- Search of a blocked or network searching GSM/UMTS module.

The table includes an exact format of the number to be called (112,911, etc.). The 'x' placeholder stands for any digit in the number to be called. The '{ }' placeholder means the rest of the number. For example:

Format	Allowed numbers
123	123 only
14x0	1400,1410,1420,...1490
999_	All numbers starting with 999

LED indication

- **GSM signal mode** – set the GSM module signal LED indication.
 - **None**
 - **Module1 only**
 - **Module2 only**
 - **All modules**

VoIP Parameters

VoIP functions

- **Day of deleting statistics on VoIP (every month)** – set the day for automatic deletion of call statistics via the VoIP interface. None = statistics will not be deleted automatically.

SIP protocol settings

- **Use CLIP from INVITE field** – define that CLIP from the 'Contact' or 'From' field shall be used for call routing to GSM/UMTS.
- **Send 180 ringing instead of 183 session progress.**
- **Send 200 OK instead of 180/183.**
- **Send 200 OK and BYE when rejected from GSM.**
- **Send 200 OK on REGISTER request** – virtual registration of device in **2N® BRI** gateway (for registration requiring equipment).
- **Replace CLIP from GSM with Caller ID.**
- **Deny DTMF according to RFC2833.**
- **Forward DTMF for ME.**

SIP registration

- **Registration expires [s]** – set the expiration time for the **2N® BRI** gateway registration data with SIP proxy.
- **Reattempt registration [s]** – set the time interval after which the request shall be resent.
- **Registration domain (realm).**
- **Caller ID.**
- **Username** – registration data with SIP proxy.
- **Password** – registration data with SIP proxy.

Voice parameters

- **First RTP port (even: 1024 – 65524)** – set the number of the first RTP port. The RTP port number must be even according to the recommendation.
- **Last RTP port (even: first RTP+10 – 65534)** – set the number of the last RTP port. The RTP port number must be even according to the recommendation. The recommended minimum RTP port range is 10.

Codecs settings

Set details for the G.711a/u or G.729 codecs.

Codecs priority

Set the types of the speech codecs to be preferred.

- **Priority 1**
- **Priority 2**
- **Priority 3**

IP addresses

- **SIP proxy (IP / GSM)** – the SIP proxy IP address from which **2N® BRI** gateway awaits the GSM outgoing call requests.

Tip

- If you keep the default values (0.0.0.0), **2N® BRI** gateway will receive requests from any IP address.

- **SIP proxy (GSM / IP)** – the SIP proxy IP address to which **2N® BRI** gateway turns in the case of GSM incoming calls.
- **SIP registrar** – SIP registration server IP address.

✓ Tip

- You can use the domain name **Registration domain (realm)** for the **SIP proxy (IP / GSM)**, **SIP proxy (GSM / IP)** and **SIP registrar** IP addresses on condition that you complete the domain name **Registration domain (realm)** and set the **DNS server address** properly in the **Web configuration / Ethernet configuration** section. The **SIP proxy** and **SIP registrar** IP addresses must be set to the default value (0.0.0.0).

- **NAT firewall** – NAT firewall IP address.
- **STUN server** – STUN server IP address (Simple Traversal of UDP through NATs (Network Address Translation)) for obtaining the public IP address with which **2N® BRI** gateway operates in the Internet. You are recommended to complete this field if **2N® BRI** gateway is installed in a private network separated from the Internet via NAT or firewall. The pre-set port for sending requests to STUN is 3478.
- **Next STUN request (60–6553, 0=off) [s]** – update of information on the **2N® BRI** gateway public IP address. Use this parameter to configure the frequency of queries routed to the STUN server.

i Note

- In case the GSM gateway is installed behind the NAT, make proper routing settings in the NAT router for the relevant ports (SIP, RTP, STUN). Integrated firewalls can also affect VoIP calls!

✓ Tip

- Should you have call troubles (such as unilateral audibility, connection errors), make sure that all the active elements on the VoIP call route have been set properly. For easy troubleshooting, try the point-to-point connection with the software IP phone (SJ phone, e.g.) in your PC and, at the same time, apply network analyzer tracing (Wireshark – www.wireshark.org).
- Refer to [Subs 5.1](#) for easy tracing by the BRI gateway.

Tones generated to VoIP

- **Ring tone to VoIP** – enable generation of a user ring tone or transfer of the real ring tone from the GSM/UMTS networks.

ISDN Parameters

Use this window to set the BRI ISDN port parameters. The appearance and count of the parameters may be different in **2N® BRI Lite** and **2N® BRI Enterprise** due to different counts of ISDN BRI ports.

BRI mode selection

- **Mode** – set the BRI1 and BRI2 (for **2N® BRI Enterprise** only) ports.

BRI1 and BRI2

- **TEI Address** – set a fixed TEI address for connection of port(s) in the Point-to-Point mode.
- **MTP** – activate assignment of the dynamic TEI address (Point-to-Multipoint mode).

Progress indicator value – set the value for each progress element for call setup. Please respect the PBX and PSTN settings to avoid wrong evaluation of messages sent by the BRI gateway and, subsequently, call setup errors. Refer to the table for the decimal numbers to be assigned to the progress messages.

Number	Meaning
OFF	Progress element is not sent in the message
1	Connection is not end-to-end ISDN, following progress messages will be sent in the speech band
2	Call destination address is not ISDN
3	Call initiator address is not ISDN
4	Call is returning to ISDN
8	Communication between interconnected systems has lead to a change of the telecommunication service (for end-to-end ISDN connection only)
10	Delay due to speech interface

BRI functions

- **Day of deleting statistics on BRI (every month)** – set this item to '0' to disable periodical (monthly) deleting of statistics. Set this value to 'x' other than '0' to enable deletion of statistic data on x-th day of a month.
- **Digits count in SETUP (en-block)** – set the count of outgoing dialling digits to be sent by the gateway in the SETUP message in the ENBLOCK format. The remaining digits will be sent in the OVERLAP format, i.e. in the information element following the SETUP message. The OVERLAP mode is used in analogue networks.

Example:

SETUP digit count: 7, user number: 601234567

Call setup messages:

```
SETUP (601234567)
INFO (6)
INFO (7)
```

- **Receive dial number from Subaddress** – use this parameter to receive dialling from the subaddress element instead of standard CDN.
- **Don't send Connect ACK on TE** – use this parameter to enable/disable sending of the CONNECT ACK message to the TE port.
- **Use CLIR if requested from ISDN (SETUP)** – enable automatic CLIR resending to GSM/UMTS if required so by the ISDN.

Tone signalling for calls from ISDN

- **Dial tone to BRI1 with empty SETUP** – set the dial tone type to be generated by the BRI gateway.
- **Ring tone** – set the ring tone type to be generated by the BRI gateway.
- **Generate busy tone to BRI1** – set the busy tone type to be generated by the BRI gateway into the BRI 1 interface.
- **Generate busy tone to BRI2** – set the busy tone type to be generated by the BRI gateway into the BRI 2 interface.

Numbering plan settings

CDN, CGN – use these parameters to set the **Numbering plan** for the called (CDN) and calling (CGN) numbers.

Binary value	Decimal value	Description
0000	0	Unknown numbering plan
0001	1	ISDN/Telephony numbering plan
0011	3	Sata numbering plan
0100	4	Telex numbering plan
1000	8	National standard numbering plan
1001	9	Private numbering plan
1111	15	Reserved for Extension

ISDN Parameters – Monitoring

Upozornění

- This service is subject to licence! Refer to **Management/Licence key** for the current GSM gateway licence state details.

BRI1 alerts

- **Still activated ISDN layer 1** – enable/disable keeping of ISDN layer 1 active.
- **Still activated ISDN layer 2 (SABME/UA)** – enable/disable keeping of ISDN layer 2 active.
- **Send SMS at state changes** – enable/disable alert sending upon BRI1 state change.

BRI2 alerts

- **Still activated ISDN layer 1** – enable/disable keeping of ISDN layer 1 active.
- **Still activated ISDN layer 2 (SABME/UA)** – enable/disable keeping of ISDN layer 2 active.
- **Send SMS at state changes** – enable/disable alert sending upon BRI1 state change.

BRI common settings

- **Timeout for ISDN line deactivation detection [s]** – an SMS alert on BRI1/BRI2 deactivation is sent after this timeout.
- **Timeout for ISDN line activation detection [s]** – an SMS alert on BRI1/BRI2 activation is sent after this timeout.
- **Numbers where SMS will be sent to** – list of numbers to which the SMS alert shall be sent.
- **Text of SMS** – SMS alert text with the following parameters:
 - %P(x|y), where "x" represents any text concerning BRI1 and "y" represents any text concerning BRI2.
 - %A(x|y), where "x" represents any text for interface deactivation and "y" represents any text for interface activation.

Settings of Alive SMS interval

- **Send Alive SMS** – enable/disable sending of ALIVE SMS.
- **Time [hh:mm]** – ALIVE SMS sending time.
- **Days interval** – ALIVE SMS sending interval.
- **Numbers where SMS will be sent to** – list of numbers to which the ALIVE SMS shall be sent.
- **Text of SMS** – ALIVE SMS text.

GSM Basic Parameters

GSM selection

- **Assignment of GSM-channel**
 - Cyclical
 - Locked - peer to ISDN channel
 - Smart - least used minutes
 - Smart - most remaining minutes
 - Linear - always first free module

Caution

- The **Locked - peer to ISDN channel** selection has a higher priority than the LCR table. All outgoing/incoming calls are locked in the GSM-ISDN channel pair. The GSM channel is selected cyclically for outgoing VoIP calls.
- The **Smart – least used minutes and Smart – most remaining minutes** rules are useful where different limit settings are used for SMS.

Number of digits dialled from VoIP

- **Minimum numbers from VoIP** – set the minimum count of digits to be dialled into the GSM network.
- **Maximum numbers from VoIP** – set the maximum count of digits to be dialled into the GSM network.
- **Wait for next digit [s]** – set the timeout for 2N® BRI gateway to wait for the next digit dialled from VoIP to GSM.

Calls

- **Relax timeout [s]** – set the timeout between the end of the last call and beginning of the next call made via one and the same GSM module (incoming and outgoing calls are rejected during this timeout). The recommended relax value is 2 seconds – please do not change this setting unless absolutely necessary.
- **Timeout for ringing to GSM [s]** – ringing timeout for outgoing calls to GSM. If not answered or terminated within this timeout, the call will be terminated automatically by the gateway when this timeout elapses.
- **Source interface for CallBack** – select the CallBack source interface for CallBack routing. The LCR table must include the appropriate outgoing traffic rule: if, for example, a VoIP port is the CallBack source interface, routing from VoIP to GSM must be defined in the LCR.
- **Delay for fast CallBack [s]** – set the delay between the CallBack request and outgoing call if Auto end to CallBack request is active.

Holiday list

List of days on which calls will be routed like on weekends in the LCR.

DTMF settings

Minimum delay between two identical DTMF characters [s/100] received.

Tone detector settings

The GSM gateway can automatically detect user defined tones transmitted by GSM/UMTS for setting up outgoing calls to the GSM/UMTS networks. In general, they are tones of a transferred number. For the purpose of such detection, the GSM gateway automatically terminates the call and tries to set it up via another available outgoing group (if defined in the LCR).

- **Frequency 1;2;3;4** – define the frequencies for the tone to be detected.
- **Sequence list** – set the sequence of the tones to be detected.

Voice message detector settings

- **Minimum percent to match** – set the match percentage range in which the voice message is detected as identical with one of the voice messages recorded in the **Gateway control / Voice messages** section under index 30 - 37. The recommended value is 70-90%.

Cinterion Module Settings

- **Transmission volume [dB]** – set the module volume for the outgoing direction.
- **Reception volume [dB]** – set the module volume for the incoming direction
- **Enable connection tone** – enable the connection tone.
- **End call with SHUP** – end calls with the SHUP command.
- **Enable HR codec** – enable the Half Rate codec for the GSM network.
- **Enable AMR codec** – enable the Adaptive Multi-Rate codec for the GSM network.

Wavecom Module Settings

- **Transmission volume [dB]** – set the module volume for the outgoing direction.
- **Reception volume [dB]** – set the module volume for the incoming direction
- **GSM-band selection** – select the GSM frequencies for the mobile network.
- **Echo cancelling** – enable/disable echo cancelling for the module.
- **Enable HR codec** – enable the Half Rate codec for the GSM network.
- **Enable AMR codec** – enable the Adaptive Multi-Rate codec for the GSM network.

Telit Module Settings

- **Transmission volume [dB]** – set the module volume for the outgoing direction.
- **Reception volume [dB]** – set the module volume for the incoming direction
- **Type of used networks** – select the network types for the module to log in.
- **Automatic band selection** – enable the automatic mobile frequency band selection.
- **GSM-band selection** – select the GSM frequencies for the mobile network.
- **UMTS-band selection** – select the GUMTS frequencies for the mobile network.
- **Enable HR codec** – enable the Half Rate codec for the GSM network.
- **Enable AMR codec** – enable the Adaptive Multi-Rate codec for the GSM network.
- **Enable FR AMR Wideband codec** – enable the Full Rate Adaptive Multi-Rate codec for UMTS.
- **Enable UMTS AMR Version 2 codec** – enable the Full Rate Adaptive Multi-Rate version 2 codec for UMTS.
- **Enable UMTS AMR Wideband codec** – enable the Adaptive Multi-Rate WideBand for UMTS.
- **Enable echo canceller** – enable/disable echo cancelling for the module.
- **Enable noise reduction** – enable/disable noise reduction for the module.

Warning

- The GSM/UMTS codec and noise reduction settings of the above listed module types may affect the DTMF detection quality. Make sure that the settings comply with the mobile network used.

Audio level DSP

Set the voice level for calls in the gateway signal processor.

- **Output audio level DSP [dB]** – audio volume gain/loss to VoIP
- **Input audio level DSP [dB]** – audio volume gain/loss to GSM

Caution

- An extremely high voice level may lead to poor voice quality (distortion, echo, etc.) and wrong DTMF detection!

Tone generated for incoming calls from GSM/UMTS

- **Dial tone** – set the dial tone for incoming calls from GSM/UMTS.
- **Ring tone** – set the ring tone for incoming calls from GSM/UMTS.
- **Generate busy tone to GSM/UMTS** – enable busy tone generation for call termination.



Caution

- If the **Generate busy tone** function is enabled, the duration of outgoing calls billed by the GSM/UMTS provider will be extended!

Error GSM/UMTS causes

- Set the ISDN release cause for each of the below mentioned statuses. Every call that meets any of the below mentioned requirements, will be rejected with a user defined cause (the ISDN cause number will be translated to VoIP as a SIP code as defined below).
 - **Lack of digits in OVERLAP mode** – any call that fails to meet the minimum digits count requirement will be rejected.
 - **Restricted number prefix** – any call whose prefix is not included in any of the prefix lists will be rejected.
 - **Selected module / GSM group is not ready** – a call will be rejected in case there is no available GSM module in the selected (by LCR) outgoing GSM group.
 - **Selected module / GSM groups are not ready** – a call will be rejected in case there is no available GSM module in the selected (by LCR) outgoing GSM groups.

Cause translation

The release cause received from GSM/UMTS can be converted into another ISDN release cause. The resultant ISDN cause number will be converted into a SIP code according to the table below:

Conversion table:

ISDN cause value	Description	SIP code	Description
1	Unallocated number	410	Gone
3	No route to destination	404	Not found
6	Channel unacceptable	503	Service unavailable
16	Normal call clearing	BYE	
17	User busy	486	Busy here
18	No user responding	480	Temporarily unavail.
19	No answer from user	480	Temporarily unavail.
21	Call rejected	603	Decline
22	Number changed	410	Gone
27	Destination out of order	404	Not found
28	Address incomplete	484	Address incomplete
29	Facility rejected	501	Not implemented
31	Normal, unspecified	BYE	
34	No circuit available	503	Service unavailable
38	Network out of order	503	Service unavailable
41	Temporary failure	503	Service unavailable
42	Switching equipment congestion	503	Service unavailable
44	Requested facility not subscribed	503	Service unavailable
47	Resource unavailable	503	Service unavailable
50	Requested facility not subscribed	503	Service unavailable
55	Incoming class barred within CVG	603	Decline
57	Bearer capability not authorised	501	Not implemented
58	Bearer cap, unavailable at present	503	Not implemented
63	Service or option unavailable	501	Service unavailable
65	Bearer cap, not implemented	501	Not implemented
79	Service or option not implemented	501	Not implemented
87	User not member of CVG	603	Decline
88	Incompatible destination	400	Bad request
98	Invalid message	400	Bad request
102	Recover on timer expiry	408	Request timeout
XXX	The other received CAU from netw.	500	Internal server error

Others

- **Text of SMS at no answer** – edit the text of the SMS to be sent to the calling party in case of no answer (if the function is active). The %N string will insert the CLIP received from VoIP/BRI in the SMS text.
- **Text of SMS for all calls** – complete this parameter to make the GSM gateway send SMS to every called party regardless of whether or not the call was successfully connected. The %N string will insert the CLIP received from VoIP in the SMS text.
- **Save received SMS to** – select the storage for received SMS messages.
- **SIM card identification** – set the SIM Id (IMSI/SCID) to be entered in the CDR.
- **Disable CLIP from GSM/UMTS to VoIP** – enable/disable resending of the CLIP from GSM to VoIP.
- **Reject call with CHLD** – enable rejection of incoming calls from GSM/UMTS via AT+CHLD (subscriber busy) instead of standard ATH.
- **Network registration timeout [min]** – set the timeout after which the module must log in. The login process will be restarted after this timeout.

GSM Group Assignment

Here you can assign the GSM/UMTS modules to groups. You can assign incoming and outgoing calls separately using the parameters below.

GSM Outgoing Groups

2N® BRI gateway allows you to work with two groups of outgoing calls. You can set different values (call setup, called minutes and sent SMS per period, etc.) for each of them.

General settings

- **Delay for CONNECT [s]** – set the delay between receiving a GSM call and sending the CONNECT message.
- **Minimum ring duration to send SMS at no answer [s]** – set the minimum ringing timeout for sending the SMS at no answer.

Note

- The INVITE message must contain the called and calling numbers in order that the **SMS at no answer** function may work properly.

- **Delay for ALERTING [a]** – set the delay before sending the ALERTING message.
 - **off** – no Alerting message will be forwarded.
 - **real** – the Alerting message will be forwarded as soon as the gateway receives Alerting from the wireless network or ring tone detectors detect the alerting tone (if active).
 - **1-20** – the Alerting message will be automatically sent after a predefined number of seconds after the call is dialled into wireless network.
- **Minute parameter** – define whether the GSM gateway shall consider call duration or count while limiting outgoing calls.
- **Day of deleting statistics in group (every month)** – set a day on which statistic data on disconnected calls shall be deleted.
- **Generate virtual ring tone** – enable/disable generation of the virtual ringing

tone into the VoIP interface.

- **Call length counting** – define whether call minutes or seconds shall be counted.
- **After call relax delay** – set the time between the end of the current call and start of the next call via one and the same GSM/UMTS module. The recommended value for heavy-traffic installations is 2 seconds!
 - **Add random time** – use this auxiliary parameter to add random time in seconds. Thus, the resultant time is the sum of the two above mentioned parameters.

Network settings

- **BTS lock** – identify the BTS to which the GSM modules shall log in. Restart the selected GSM modules to execute the changes.

Caution

- The BTS lock service work with specific GSM modules only (Q55, Q24, GE910, HE910)!
- If you set a wrong BTS lock, the selected GSM module(s) will not log in to GSM.

- **Network operator code (MCC+MNC)** – set the local mobile network provider code manually. If you do not enter a value, the provider will be selected automatically.
- **Number of registration attempts** – set the count of network registration attempts if the network rejects to register the +CREG:3 SIM responses.
- **Delay after registration denied (1-600) [s]** – set the registration delay, i.e. the timeout within which the network may send another response after rejecting +CREG:3.
- **Timeout for registration (10-600) [s]** – set the maximum timeout for the module to wait for network login in the NWAIT mode.
- **Next try for registration (0=off, 1-720) [m]** – set the interval between relogging attempts.
- **Enable USIM and SIM Application Toolkit** – enable/disable the USIM and SIM Application Toolkit services for the Telit HE/GE 910 modules.

Disconnect Call

Set the rules for automatic disconnection of outgoing calls to a wireless network.

- **SIM limit exceeded** – automatic call disconnection when the active SIM card call limit is exceeded.
- **Time limit exceeded** – automatic call disconnection when the active SIM card time of use is exhausted.
- **No ALERTING before CONNECT** – automatic call disconnection when the gateway receives the call connect message without alerting.

Send CLIP from VoIP to GSM/UMTS

- **Transfer CLIP to GSM/UMTS** – enable/disable the function.
- **Separating char** – define the CDN/CLIP separating character.
- **Modify ('-' remove one digit)** – change the CLIP. The '-' character is used for deleting one character from the left.

⚠ Caution

- The **Send CLIP from VoIP to GSM** service must be supported by the GSM/UMTS provider's network. Otherwise, the call may be rejected by GSM/UMTS!

GPRS activation

- **APN string** – define the Access Point Name (APN) for GPRS connectivity.

Basic settings

- Roaming enabled for network code – international code for the roaming enabled network. The code consists of the following two numbers:
 - **MCC** – Mobile Country Code – national code (Czech Republic – 230, e.g.)
 - **MNC** – Mobile Network Code – GSM network code (T-Mobile 01, 0202, Vodafone 03, e.g.)

Hence, the T-Mobile CZ international code is 23001. Leave the field empty to disable roaming.

String	Note
<empty>	Roaming disabled
2300	Roaming disabled (five digits at least)
23002	Roaming enabled for the 23002 (MCC+MNC) network
230XX	Roaming enabled for the 23000 – 23099 (MCC+MNC) network
XX001	Roaming enabled for the 00001 – 99001 (MCC+MNC) network
XXXXX	Roaming enabled for any network

ℹ Note

- Before enabling roaming, please use your mobile phone to make sure that the GSM/UMTS searching priorities have been set properly on the SIM card.

⚠ Caution

- Calls via a roaming network may increase your telephone call costs!

- **CLIR** – enable/disable presentation of the SIM CLI on the called party's telephone. CLIR is recommended for the SIM card inserted in the GSM module to avoid CallBack problems.

⚠ Caution

- The **Temporary CLIP enable** and **Temporary CLIR enable** services must be supported by the GSM/UMTS provider's network. Otherwise, the call may be rejected by GSM/UMTS!

- **Maximum number of called minutes** – define the maximum count of minutes to be called within a month via the selected SIM card.
- **SMS messages number** – define the maximum count of SMS messages to be sent within a month via the selected SIM card.

- **Day of restoring call limit and delete statistics** – select a day in a month on which the **Max count of called minutes** and **Count of SMS messages** statistics shall be deleted.
- **First count** – set the length of the first pulse after which the pulse counting change starts as defined in the **Next count** parameter.
- **Next count** – set the length of one pulse in seconds after the time defined in the **First count** parameter elapses.

 **Note**

- Set the two parameters above (**First count**, **Next count**) properly to count free minutes on SIM cards correctly. These parameters are used for limiting outgoing calls depending on free minutes. The CDRs contain real data.

- **Day limit of called minutes** – set the maximum count of minutes to be called within a day via the selected SIM card.
- **AOC sending interval** – set the interval to send AOC messages

Time limits

There are two SIM use time limits in a GSM group.

Call tariffs

Use this function to assign up to four independent free minute counters to a group of GSM modules (SIM cards), e.g.:

Tariff 1 = free minutes for calls to own GSM/UMTS network;

Tariff 2 = free minutes for calls to other GSM/UMTS networks;

Tariff 3 = free minutes for calls to fixed network;

Tariff 4 = free minutes for calls within a closed user group (VPN).

Complete the LCR table (assign prefixes to tariffs) properly to make full use of this function. If routing to a tariff is not used, the global free minutes function will be used in the LCR table.

- **Free minutes** - set the free minutes for the tariff offered by the provider.
- **Transferred minutes** - set the maximum count of free minutes to be transferred to the next period.
- **AOC sending interval** – set the interval to send AOC messages.
- **Day of restoring free minutes** - set a day on which the free minute counters will be reset automatically. Select every 24 hours, a day in a month, or a day in a week.
- **Week of restoring free minutes in month** - set a week in which the free minute counters will be reset automatically. Set the week number only if the restoration takes place **every other Friday** in a month, e.g., or keep **Every** for the other cases.

 **Caution**

- The recommended free minute counter value is X-5, where X is the number of free minutes obtained from the GSM/UMTS provider. Thus, you can avoid exceeding limits.
- The manufacturer is not responsible for additional call costs incurred as a result of exceeding your GSM/UMTS provider's free minute/SMS limit.

GSM Incoming Groups

2N® BRI gateway allows you to work with two groups of incoming calls. You can set different values for each of them.

General settings

- **Mode** – set how the gateway shall process incoming calls from the GSM network.
 - **Reject incoming calls** – all incoming calls from the GSM network are rejected automatically.
 - **Ignore incoming calls** – all incoming calls from the GSM network are ignored. The calling party hears the check ring tone.
 - **Accept incoming calls + voice message** – incoming GSM calls are accepted by the gateway and, if programmed so, DTMF with a voice message is activated for them.
 - **Accept incoming calls + dialtone** – incoming GSM calls are accepted by the gateway and, if programmed so, DTMF with a simulated second dialtone is activated for them.
 - **CallBack after ring / Reject** – CallBack will be made if the CLIP is included in the CallBack table. The other incoming calls will be rejected.
 - **CallBack after ring / Ignore** – CallBack will be made if the CLIP is included in the CallBack table. The other incoming calls will be ignored.
 - **Report to PC + voice message** – the GSM gateway sends information on the incoming call to a PC equipped with call routing application. If programmed so, DTMF with a voice message is activated for the incoming call.
 - **Report to PC + dialtone** – the GSM gateway sends information on the incoming call to a PC equipped with call routing application. If programmed so, DTMF with a simulated second dialtone is activated for the incoming call.
- **Minimum digits in DTMF** – set the minimum count of digits to be requested by the gateway for DTMF.
- **Maximum digits in DTMF** – set the maximum count of digits to be accepted by the gateway for DTMF.
- **Timeout for entering DTMF digits [s]** – set the timeout for which the GSM gateway shall wait for the first/next DTMF digit. If you select '0', the incoming call will be automatically connected to the numbers included in the **List of called numbers**.
- **Day of deleting GSM group statistics** – set a day in a month on which the incoming call statistics shall be deleted.
- **Prefix before DISA** – set a numerical prefix to precede DTMF.
- **CLIP** – use this parameter to modify the incoming CLIP from GSM/UMTS. For international codes, '+' will be removed automatically. Use '-' to remove a digit. Examples (CLIP in GSM: +420600123456):

Parameter	CLIP to VoIP/PRI 1	Note
Null	420261301500	No CLIP change
+	+420261301500	Add + before CLIP
00	00420261301500	Add 00 before CLIP
-	0261301500	First two digits removed from CLIP
---99	99261301500	First three digits removed from CLIP, prefix 99 added

- **Looping of voice message** – set the voice message playing time.

Send CLIP from GSM/UMTS to VoIP

- **Transfer CLIP from GSM/UMTS** – enable/disable the function.
- **Separating char** – set the separator for the SIM card CLIP and ID of the extension to be called.
- **Modify** – modify the extension ID.



Caution

- The **Send CLIP from VoIP to GSM** service must be supported by the GSM/UMTS provider's network. Otherwise, the call may be rejected by GSM/UMTS.

Others

- **Time to keep CLIP in table** – set the record keeping time for AutoCLIP routing.
- **Add record only for unconnected call** – enable storing of unconnected outgoing calls in the AutoCLIP table only.
- **Delete record for connected answer** – enable deletion of an AutoCLIP record in the case of successful CallBack.
- **Skip DTMF for numbers not in CLIP Routing table** – enable this option to set DTMF to the incoming calls only whose CLIP is included in the CLIP Routing table. Make sure that the called number table includes one record at least to make the function work.
- **Skip list of called numbers after failed call to wanted number** – enable this function to disable forwarding of incoming calls to the numbers included in the **List of called numbers** if rejected after DTMF.
- **Auto end to CallBack request** – enable that the incoming call whose CLIP meets the CallBack settings will be rejected. If not, the call will be ignored. The CallBack function will be retrieved after call end in both the cases.

List of called numbers

List of numbers to be dialled if DTMF dial-in was not made. Search the table from top to bottom. If the called user is inaccessible, use the following table record.

Prefixes

Use this window to adapt the gateway to calling to various GSM providers' networks. Set the call routing rules based on prefixes for up to sixteen groups.

Prefix list 1–16

Sixteen prefix groups to be assigned in the LCR table.

Basic settings

- **GSM network ID** – set the prefix list user code for easier orientation in the LCR.
- **Default count of digits** – default length of the number to be dialled into the GSM/UMTS networks for routing via the selected prefix list. Use this parameter in case the **Digits count** is not included in the **Accepted prefixes** table.

Note

- The number to be dialled to the GSM/UMTS network must meet the **Count of digits** condition.
- For **VoIP** calls, the count of digits to be dialled must be equal to or higher than the value set in the **Count of digits**.
- For GSM/UMTS calls by overlap dialling via the **BRI NT/TE** interface, the **Count of digits** defines the maximum count of the digits to be dialled.
- For GSM/UMTS calls by block dialling via the **BRI NT/TE** interface, the **Count of digits** is ignored.

Table of replaced prefixes

Use this table to replace the prefix of the received number ('00' with '+', e.g.). You can only add or remove the prefix. This change is made before the prefix is searched for in the prefix table. Be sure to keep the „/" record in the table for a proper function.

Note

- The maximum count of records in the **Table of replaced prefixes** is 14 for each prefixlist.
- The maximum table record size is 9 characters for the prefix and 9 characters for the replaced number.

Table of accepted prefixes

List of prefixes of called destinations to which the selected prefix list applies.

Note

- The maximum count of records in the **Table of accepted prefixes** is 138 for each prefixlist.
- The maximum table record size is 9 characters.

LCR Table

Table of outgoing Least Cost Routing (LCR) rules. Every outgoing call from the source interface is routed to the destination interface according to this table. For a call, the gateway checks the lines and if the called number prefix matches the prefix in the selected network list and the current time value is within time limitation limits, the call will be routed via the defined GSM group(s) or BRI 1/BRI 2/VoIP interface.

- **From (channels/groups)** – source channels or groups via which calls are routed to **2N® BRI** gateway.
 - **GSM ALL** – any of the GSM incoming groups can be used for call routing.
 - **GSM GRP1-2** – define one GSM incoming group or a range of GSM incoming groups via which call routing will be enabled.
 - **BRI1 (pxx,P)** – any of the BRI1 channels can be used for call routing.
 - **BRI1 (p1-2)** – define one BRI1 channel or a range of BRI1 channels via which call routing will be enabled.
 - **BRI2 (exx,E)** – any of the BRI2 channels can be used for call routing.
 - **BRI2 (e1-2)** – define one BRI2 channel or a range of BRI2 channels via which call routing will be enabled.

- **VoIP (vxx,V)** – calls are routed via the VoIP interface.
- **Prefix list** – prefixes to be used for a selected LCR row. Set up to 16 prefix lists.
 - **Prefixlist 1-16** – call routing will obey the rules set in Prefix list 1-16. The count of digits to be dialled is governed by the Prefixes setting.
 - **All prefixes** – all the prefix lists are permitted. Prefix lists 1-16 will be searched from 1 to 16. The first match will be used routing. For incoming GSM calls, the Count of digits from the GSM incoming group parameter will be applied.
 - **Number of digits** – all the prefixes are permitted. Routing is only limited by the count of digits to be dialled.
- **Time limitation** – time validity limitation for a selected LCR row.
- **Weekend usage** – enable/disable a row on weekends.
- **Call duration limit** – set the maximum duration (minutes) for an outgoing call to the GSM/UMTS network.
- **Groups** – define the outgoing GSM groups or interface via which outgoing calls will be routed from **2N® BRI** gateway. If the defined interface is inactive or the outgoing GSM group tariff is exhausted, the next row will be applied.
 - **GSM groups 1-2** – outgoing GSM groups. Set the tariff to be used. Refer to the GSM outgoing groups subsection for details.
 - **BRI1 (P)** – ISDN BRI1 interface. Refer to the **ISDN parameters** subsection for details.
 - **BRI2 (E)** – ISDN BRI2 interface. Refer to the **ISDN parameters** subsection for details.
 - **VoIP (V)** – VoIP interface. Refer to the **VoIP parameters** subsection for details.
- **Tariffs** – select the tariff group (free minute counter) to be used for the outgoing call. Refer to the GSM outgoing groups subsection for details.
- **Ignore tone detection in last group** – having detected a user defined tone (refer to GSM basic settings), the GSM gateway automatically terminates the call and seeks for another call setup way. If this parameter is activated, the GSM gateway ignores the tone detection results and sets up a call when this is the only possible call establishing way.

Note

- If you use tariff routing, set the tariffs properly in the GSM outgoing groups subsection.
- The maximum count of LCR table records is 64.
- The rules are applied to calls sequentially, starting from the first rule. If all the set rules are met in a row, the call is routed according to the row.
- Call routing from BRI1/BRI1, BRI2/BRI2 and VoIP/VoIP is not supported. Such calls will be rejected by **2N® BRI** gateway.

CLIP Routing Table + CallBack

Use the table to set a fixed CLIP assignment of incoming CLIPs from GSM to the numbers of extensions to which incoming calls are routed automatically. Also, set the CLIP list in the GSM network for which CallBack is enabled.

- **GSM number (CLIP)** – user Id in GSM/UMTS.
- **Used service**
 - **Autodial** – enable/disable CLIP routing for the selected CLIP.
 - **Reject call** – reject call for the selected CLIP.
 - **Ignore call** – ignore call for the selected CLIP.
 - **Tone dial-in** – incoming GSM calls is accepted + dialtone is activated for the selected CLIP.

- **DISA message dial-in** – incoming GSM calls is accepted + voice message is activated for the selected CLIP.
- **Dial to VoIP/ISDN** – VoIP destination number for the CLIP routing function.
- **Auto CallBack** – enable/disable the CallBack function for the selected CLIP according to the **Gateway configuration / GSM basic settings / Calls / Source interface for CallBack** setting.
- **Call duration limit** – set the maximum call duration (minutes).

Tip

- CallBack detects the CLIP from right to left. Thus, configure 10 rules for all the incoming CLIPs to make CallBack work properly. Each of the rules must contain one of the CLIPs: 0,1,2,3,4,5,6,7,8,9.

Note

- Remember to activate the CallBack mode in the **GSM incoming groups** for a proper function.
- The maximum count of CLIP routing table records is 96.

Mobility Extension

Use this table to register the Mobility Extension users.

- **Name** – user name for calling to VoIP.
- **User** – registration user name for VoIP.
- **Password** – registration user password for VoIP.
- **GSM number (CLIP)** – user SIM card CLIP.
- **Follow me function** – enable/disable call forwarding to the user mobile station (according to CLIP).
- **SMS at no answer function** – enable/disable sending of SMS on missed calls.

Ethernet Configuration

Use this window to set the gateway Ethernet interface.

- **Use DHCP** – enable/disable the DHCP client function for **2N® BRI** gateway.
- **IP address** – fixed IP address (v4) for the **2N® BRI** gateway Ethernet interface.
- **Subnet mask** – network mask for the **2N® BRI** gateway Ethernet interface.
- **Default gateway** – IP address (v4) of the IP gateway in the Ethernet.
- **DNS server1** – primary DNS server.
- **DNS server2** – secondary DNS server. Used as a back-up when DNS server 1 is not functional.

Caution

- Saving wrong values, e.g. DHCP enable, may result in making the **2N® BRI** gateway configuration part inaccessible. In that case, reset the GSM gateway to factory values; refer to [Subs.4.1](#).

Tip

- If the gateway is in the DHCP client mode, the current values obtained from the DHCP server are displayed in the IP address, Subnet mask and Default gateway items.

Login Configuration

Use this window to set the access password and name for the **2N® BRI** gateway web interface. Use the same access data for Telnet connection too.

Caution

- **Change** the user name and password during your **first** gateway configuration to avoid unauthorised access to your gateway configuration!

Note

- The username and password may have up to 30 characters in total.

Web Configuration

Set additional parameters for web access to the GSM gateway.

- **Auto logout** – set the count of minutes in which the user will be logged out automatically.
- **Enable web session lock** – one Admin user may be connected to the GSM gateway at one time. If another duly authorised user tries to log in, the preceding session will be terminated automatically. If you activate this function, no automatic logout will occur and any other access attempts will be blocked.
- **Simple login form** – activate this item to change the graphic appearance of the login window into an anonymous look. This function is recommended for direct connection of the GSM gateway to the Internet.
- **Use SMS user for SMS operations on the web** – enable/disable a user authorised to send/receive SMS messages only.
- **SMS user name/password** – connect a user with the right to receive/send SMS only.

Report Configuration

Use the window to set details for automatic tracing generated by the GSM gateway.

Time Synchronisation

Set the NTP server time synchronisation.

General

- **Type** - enable/disable synchronisation.
- **Ntp server** - NTP server address and port.
- **Timezone** - set the time change from UTC.

Summer/Winter Time

- **Automatically switch to summer/winter time** - enable/disable automatic winter/summer time transition.
- **Switch to summer time** - set the summer time transition date and time.
- **Switch to winter time** - set the winter time transition date and time.

Messaging

This group helps:

- Set the GSM gateway to send/receive SMS via SMTP/POP3 or SMPP
- Define the routing rules for incoming and outgoing SMS messages
- Check the GSM gateway SMS database filling capacity



Caution

- This service is file-licensed. Refer to **Management / Licence key** for the current GSM gateway licence details.

Modules Grouping

Global settings

- **SMS server enabled** – enable/disable the SMS server at the GSM gateway (keep disabled if you select another SMS processing method).
- **AutoCLIP routing expires [hours] (1-10000, 0=off)** – set the maximum time for keeping of the automatic SMS routing record (response) in the AutoCLIP table.
- **Not sent SMS expires in [hours] (1-10000, 0=off)** – delete an SMS in case it was not sent within the timeout.
- **Received SMS expires in [hours] (1-10000, 0=off)** – delete a received SMS in case it was not delivered to the e-mail / SMPP user within the timeout.
- **Delivery Report expires in [hours] (1-10000, 0=off)** – delete an SMS waiting for delivery report and make an error record in the SDR table in case no delivery report arrives within the set period of time.



Caution

- **0=off** means disabled expiry, i.e. records are saved into the AutoCLIP routing table for an indefinite period of time. Therefore, make sure that the routing priorities are set properly for incoming SMS. Refer to **Incoming SMS routing** for details.

Detection of Delivery Report

- **Number of digits (1-20) from the right** – set a count of digits to be detected from the SMS text end in the case of positive evaluation according to Begin of text of received SMS. The found number is compared with the addressees of the outgoing messages.
- **Begin of text of received SMS** – any SMS whose text beginning matches this parameter is evaluated as a delivery report.

Note

- If multiple SMS are sent to one and the same number, delivery reports are assigned to them according to the sending time, starting from the oldest one.

Modules to SMS groups assignment

This section helps you assign GSM modules to SMS groups (according to the GSM provider, e.g.) to facilitate incoming/outgoing SMS routing.

SMS groups to User groups assignment

This section helps you assign SMS groups to User groups for SMS sending/receiving purposes. The GSM gateway can contain up to four User groups.

Modules to SMS groups assignment

Module: 0 1
SMS group: 0 0

SMS groups to User groups assignment

SMS group: 0 1
User group: 1 1

Caution

- The count of user accounts is file-licensed. Refer to **Management / Licence key** for the current GSM gateway licence details.

Users

This section helps you manage the SMS users. Select a communication protocol for user adding (SMTP/POP3 or SMPP).

Add user

- **User group** – assign the user to a User group.
- **User full name** – define the system user name.
- **Replace dial for outgoing SMS** – define the number (CPN) to which the user's outgoing SMS messages shall be sent.
- **Access type** – select the communication protocol for SMS processing:
 - **Email (SMTP/POP3)** – use SMTP for SMS sending and POP3 for SMS receiving.
 - **SMPP (SMSC)** – set the GSM gateway into the 'SMS centre' mode.
 - **SMPP (ESME)** – set the GSM gateway into the 'ESME - External Short Messaging Entity' mode.
 - **Web** – define an account for sending SMS via the SMS web interface.
- **Login name (without domain)** – define the login name for the client Email.
- **System ID** – SMSC user ID.
- **Password** – SMSC/SMTP user password.
- **System ID (for authentication on remote side)** – ESME user ID.
- **Password (for authentication on remote side)** – ESME user ID.
- **TCP type** – set the TCP parameter into the client/server mode.
- **Server address** – set the server IP address and TCP server transport port.
- **Message direction of Esme** – set the ESME user details:
 - **Transceiver** – ESME works as a transmitter/receiver.
 - **Transmitter** – ESME works as a transmitter.
 - **Receiver** – ESME works as a receiver.
- **Address range** – set this parameter if required so by SMSC for SMS receiving.
- **SMPP timeout** – set the EnquireLink timeout for active connection keeping.
- **Delivery status required** – set the SMS sending request for outgoing SMS delivery confirmation.
- **Send message as Flash SMS** – activate the Flash SMS function for outgoing SMS messages.

Note

- You can set the **Delivery status required** parameter only if the SMTP/POP3 protocol is used.
- With SMPP, the delivery information is active automatically in case the service is required by the SMPP counterparty or via an incoming SMS message from the GSM/UMTS network.
- The user count is licence-limited. The highest possible count of licensed users is 200. Refer to **Management / Licence key** for the current GSM gateway licence details.
- The maximum count of SMPP user accounts is 16. With the Email/Web user accounts, the maximum count is 200 as specified in the licence.

Add record

User group: 1

User full name:

Replace dial for outgoing SMS:

Access type: SMPP (ESME)

Login name (without domain):

System ID:

Password:

System ID (for authentication on remote side):

Password (for authentication on remote side):

Tcp type: Server

Server address: 0.0.0.0 : 2775

Message direction of Esme: Transceiver

Address range:

Delivery status required:

Send messages as Flash SMS:

Ok Cancel

User Group

This section helps you edit the User group and set the routing rules for the group's incoming and outgoing SMS.

General settings

Set the basic parameters for SMS sending via SMTP/POP3 or SMPP.

Optional informations

- **Description** – set the User group details.
- **Identical SMS limit** – set the check of identical SMS messages, i.e. sequentially sent messages with identical SMS PDUs. When the set limit is exceeded, the excessive SMS messages are discarded without being sent.

Email settings

- **Domain** – define the domain name for SMS sending/receiving via SMTP/POP3. The maximum domain length is 63 characters.
- **POP3 - Subject of email** – set the message subject to be added automatically to the SMS loaded from the GSM gateway via POP3.
- **POP3 - Subject of email (delivery acknowledgement)** – set the SMS delivery acknowledging message subject.
- **POP3 - Subject of email (not delivered)** – set the SMS non-delivery acknowledging message subject.
- **POP3 - Subject of email (send error)** – set the SMS sending failure message subject.

✔ **Tip**

- The following options are available for subject modification:
 - %% – Insert the "%" character
 - %n – CLIP number
 - %u – Login name
 - %f – User full name
 - %d – Date and time
 - %s – SIM IMSI
 - %m – Module
 - %g – Group

- **SMTP - Maximum SMS per email** – set the maximum count of SMS messages to be sent within one Email message. Any characters exceeding the set length will be ignored.
- **SMTP - Add "From" to SMS** – add 'From' from the Email message to the outgoing SMS. The sender information will be displayed at the beginning of the SMS message.
- **SMTP - Add "Subject" to SMS** – add 'Subject' from the Email message to the outgoing SMS. The subject information will be displayed at the beginning of the SMS message.

Optional informations

Description:

Identical SMS limit:

Email settings

Domain:

POP3 - Subject of email:

POP3 - Subject of email (delivery acknowledgement):

POP3 - Subject of email (not delivered):

POP3 - Subject of email (send error):

SMTP - Maximum SMS per email:

SMTP - Add "From" to SMS:

SMTP - Add "Subject" to SMS:

SMPP address modification

- **Source address of message incoming from SMPP** – set how to modify the message sender ID received via SMPP.
 - **Never replace original address**
 - **Replace if the original address is empty**
 - **Always replace original address**
 - **address** – enter sender's new ID
 - **TON** – type of number
 - **NPI** – numbering plan indicator
- **Destination address of message incoming from SMPP** – set how to modify the message addressee telephone number received via SMPP.
 - **Never replace original address**
 - **Replace if the original address is empty**
 - **Always replace original address**
 - **address** – enter addressee's new telephone number
 - **TON** – type of number
 - **NPI** – numbering plan indicator
- **Source address of message outgoing to SMPP** – set how to modify the message sender ID to be sent via SMPP.
 - **Never replace original address**
 - **Replace if the original address is empty**
 - **Always replace original address**
 - **address** – enter sender's new ID
 - **TON** – type of number
 - **NPI** – numbering plan indicator
- **Destination address of message outgoing to SMPP** – set how to modify the message addressee telephone number to be sent via SMPP.
 - **Never replace original address**
 - **Replace if the original address is empty**
 - **Always replace original address**
 - **address** – enter addressee's new telephone number
 - **TON** – type of number
 - **NPI** – numbering plan indicator

Incoming SMS routing

This section helps you set the incoming SMS routing rules, which are included in the incoming SMS routing table.

Add record

- **Disabled** – enable/disable the selected routing rule.
- **Message from SMS group** – select the SMS group that receives the SMS.
- **Action type** – select the action for the received SMS:
 - **Autoclip routing** – the incoming SMS will be routed according to the AutoCLIP table records.
 - **Deliver to user** – the SMS will be delivered to the selected user.
 - **Drop message** – the SMS will be dropped.
- **Deliver to user** – select the SMS addressee. This option is valid only if Action type = Deliver to user is selected.
- **Time limitation** – set the rule validity time.
- **Days limitation** – set the days in a week on which the rule shall be valid.
- **Clip mask** – set the filter for the SMS sender telephone number (CLIP). If the selected mask matches the CLIP, the SMS will be routed according to the rules set above. If not, the SMS will be dropped. The * character replaces any string of characters (789789789=789*, e.g.). The ? character replaces any character (789789789=789??????, e.g.).
- **Text begin** – set the string to be matched against the SMS text beginning. If a match is found, the SMS will be routed according to the rules set above.

Note

- The rules are applied to incoming SMS sequentially, starting from the first rule. If all the set rules are met in a row, the SMS is routed according to the row.
- Sending SMS depends on the outgoing routing rules set in **Messaging / User group / Outgoing SMS routing** and limits defined in **Gateway / Gateway configuration / GSM outgoing group**. When the limits get exhausted, the SMS will be stored in the outgoing SMS database until the set limits are restored.

Incoming SMS routing

Add record

Disabled:

Message from SMS group:

Action type:

Deliver to user:

Time limitation: : - :

Days limitation: Mo Tu We Th Fr Sa Su

Clip mask:

Text begin:

Outgoing SMS routing

This section helps you define the outgoing SMS routing rules, which are included in the outgoing SMS routing table.

Add record

- **Disabled** – enable/disable the selected routing rule.
- **Message to SMS group** – select the SMS group via which the SMS will be sent.
- **Action type** – select the action for the outgoing SMS:
 - **Submit from user** – enable sending SMS from the selected user.
 - **Submit from all users** – enable sending SMS from all the SMS group users.
- **Submit from user** – select the user in case Action type = Submit from user is selected.
- **Time limitation** – set the rule validity time.
- **Days limitation** – set the days in a week on which the rule shall be valid.
- **Dial mask** – set the filter for the SMS addressee telephone number (Dial). If the selected mask matches the Dial, the SMS will be routed according to the rules set above. If not, the SMS will be rejected and deleted. The * character replaces any string of characters (789789789 = 789*, e.g.). The ? character replaces any character (789789789 = 789??????, e.g.).
- **Text begin** – set the string to be matched against the SMS text beginning. If a match is found, the SMS will be routed according to the rules set above.

Note

- The rules are applied to outgoing SMS sequentially, starting from the first rule. If all the set rules are met in a row, the SMS is routed according to the row.

Outgoing SMS routing

Add record

Disabled:

Message to SMS group:

Action type:

Submit from user:

Time limitation: : - :

Days limitation: Mo Tu We Th Fr Sa Su

Dial mask:

Text begin:

Control

This section helps you monitor the system. It includes storage filling information and AutoCLIP records.

SMS queues

The subsection displays the current SMS storage state.

Incoming SMS database

The subsection displays current information on the incoming SMS storage filling percentage and maximum count of incoming storage records.

Caution

- The POP3 protocol enables you to set how long a copy of the loaded message shall be kept in the SMS server. The SMS keeping time depends on your e-mail client setting. Make sure that you have chosen a correct time value to avoid database overfilling. When the storage has been filled up, no new SMS messages will be received!

Outgoing SMS database

The subsection displays current information on the outgoing SMS storage filling percentage and maximum count of outgoing storage records.

User table

The table shows the count of incoming and outgoing SMS stored in the above-mentioned databases from the user's point of view and helps you delete the SMS stored.

User table					
Index	User	Incoming SMS count		Outgoing SMS count	
0	[0] User	0	0 / 0 / 0	0	0 / 0 / 0
			Erase		Erase

User table items:

- **Incoming SMS count** – Received / Ack OK / Ack error / Failed
 - **Received** – count of received common SMS messages
 - **Ack OK** – count of SMS delivery acknowledging messages
 - **Ack error** – count of SMS non-delivery acknowledging messages
 - **Failed** – count of SMS sending failure messages (failed due to network error, invalid number, etc.)
- **Outgoing SMS count** – Waiting / Sending / Sent
 - **Waiting** – count of waiting SMS messages
 - **Sending** – count of currently sent SMS messages
 - **Sent** – count of sent SMS messages waiting for delivery acknowledgement

Note

- If the GSM network shows a temporary error or unavailability, short SMS are sent three times and long (multipart) SMS five times. If none of the SMS sending attempts is successful, the SMS will be deleted from the outgoing SMS database and an **Incoming SMS count - Failed** message is generated by the gateway.

AutoCLIP routing table

The window displays the current state of the AutoCLIP table.

Send SMS

This section includes a web interface for SMS sending via the available user accounts. Sending SMS depends on the outgoing routing rules set in **Messaging / User group / Outgoing SMS routing** and limits defined in **Gateway / Gateway configuration / GSM outgoing group**.

- **User** – select the user account for SMS sending.
- **Phone number** – enter the SMS recipient's phone number.
- **Message** – enter the SMS text to be sent.

Note

- The maximum message length is 10 SMS. The message can use 7-bit encoding (up to 1520 characters) or 16-bit encoding (up to 670 characters).

SMTP/POP3 Basic Configuration – Step by Step

This section helps you define the **2N® BRI** basic parameters for SMS sending/receiving via SMTP/POP3. Read the [Messaging](#) subsection carefully before setting details.

Figure 1 shows sending/receiving SMS via SMTP/POP3. Having created user accounts in **2N® BRI**, the users can access the accounts via the e-mail client and send SMS messages to **2N® BRI** via SMTP. The gateway receives the messages and resends them to the GSM users according to the predefined routing rules.

A message coming to **2N® BRI** from GSM is routed according to the incoming SMS rules and delivered to the user via POP3.

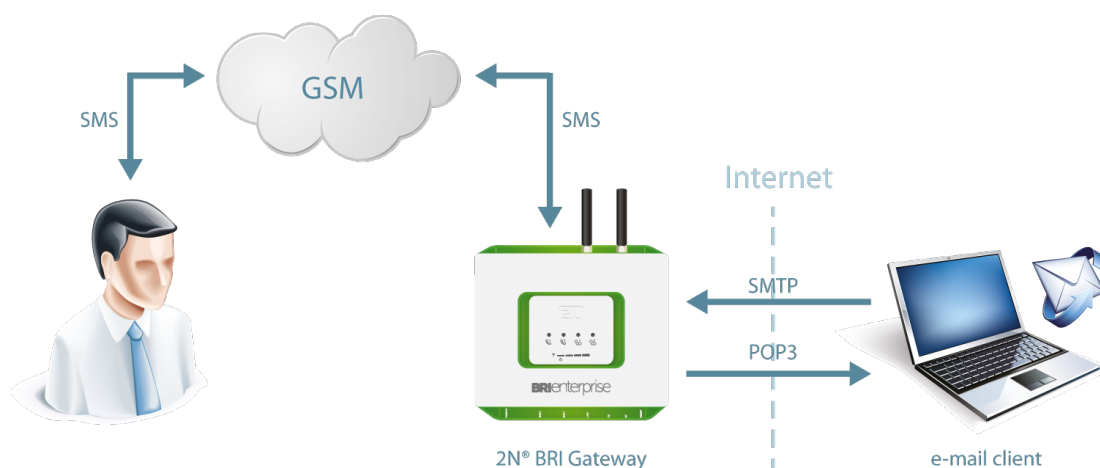

Figure 1: SMTP/POP3 Communication

Note

- You can send an SMS message of any length to up to 100 users at the same time from the e-mail client. The maximum SMS count per e-mail is only limited by the **User group / General settings SMTP / Maximum SMS per email** settings.

Take the following basic steps in **2N® BRI** to enable SMS sending/receiving:

1. In the **Messaging / SMS grouping** menu:
 - a. Assign the selected GSM modules to the SMS groups (according to the GSM provider and SIM cards with identical tariffs, for example).
 - b. Assign the SMS groups created in step 1.a above to the User groups if you use messaging with different routing rules to different company departments, for example.
2. Add users in the **Messaging / Users / Add** menu:
 - a. Assign the user to a **User group**.
 - b. Set **Access type: Email(SMTP/POP3)**.
 - c. Define the **Login name (without domain)** and **Password** to log in to the SMS server via your e-mail client.
3. Set the Domain in the **Messaging / User Group / General settings / Email settings / Domain** menu.
 - a. Set the user domain. The domain is automatically assigned to the user

name in the selected User group and represents the user e-mail address. Example: Suppose a user was created in step 2.c with **Login name: USER** and domain **Domain: email.com**, then the e-mail address of the user with the right to access the SMS server will be **USER@email.com**. The @ character is completed automatically and is not included in the Domain: field.

4. Create the incoming SMS routing rules in the **Messaging / User Group / General settings / Incoming SMS routing / Add** menu:
 - a. Select the group to receive the SMS via the **Message from SMS group**.
 - b. Select the **Action type** to define how to process incoming SMS. Example: Set **Action type: Deliver to user** to deliver SMS to selected users.
 - c. Set **Deliver to user** to define the SMS receiving user.
5. Create the outgoing SMS routing rules in the **Messaging / User Group / General settings / Outgoing SMS routing / Add** menu:

Enable the SMS server in the **Messaging / Modules grouping / SMS server enabled** menu.

 - a. Set the **SMS group** via which the outgoing SMS will be routed in the **Message to SMS group** menu.
 - b. Select the **Action type** to define how to process outgoing SMS. Example: Set **Action type: Submit from user** to send SMS from selected users.
 - c. Set **Submit from user** to define the SMS sending user.

Should you get in troubles, follow the steps below please:

- Read the User Manual carefully and check all parameters.
- Find answers to the frequently asked questions at <http://faq.2n.cz>.
- Consult your servicing partner.

You are recommended to attend a 2N certified training to improve your installation chances.

SMPP Basic Configuration – Step by Step

This section helps you define the basic parameters for SMS sending/receiving via SMPP in **2N[®] BRI**. Read the [Messaging](#) subsection carefully before setting details.

Figure 1 shows sending/receiving SMS via SMPP. Having created user accounts in **2N[®] BRI**, the users can send/receive SMS via SMPP. The figure shows an example with two SMSC accounts created in **2N[®] BRI** (to the right). Another **2N[®] BRI** (ESME) gateway and a PC on which the SMPP (ESME) application is running are connected to these accounts via SMPP. An SMS coming to **2N[®] BRI** via SMPP is routed according to the gateway outgoing routing rules and sent to GSM. An SMS coming from GSM is routed according to the gateway incoming routing rules and sent to the destination via SMPP.

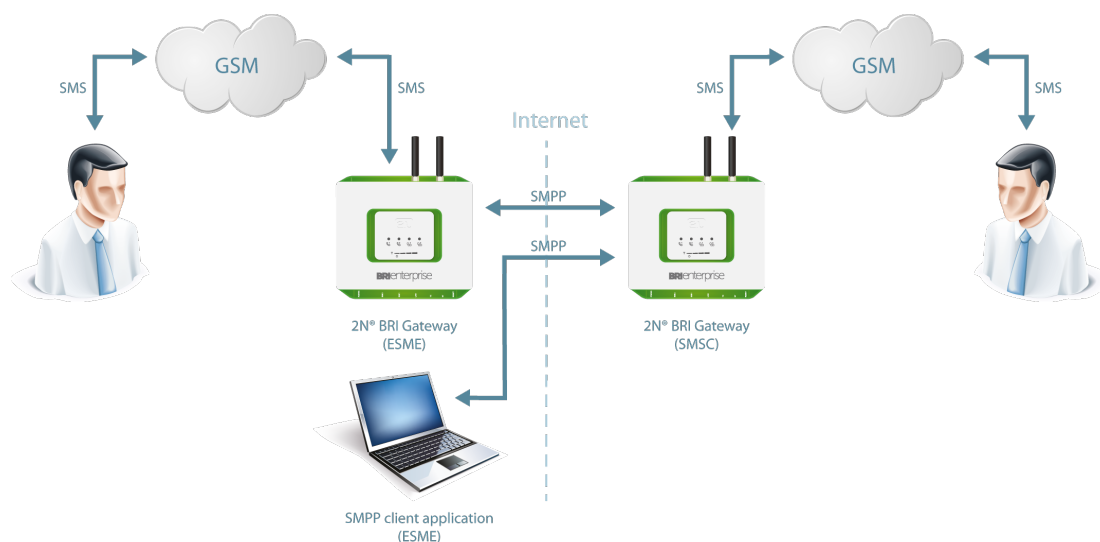

Figure 1: SMPP Communication

Take the following basic steps in **2N[®] BRI** to enable SMS sending/receiving:

1. In the **Messaging / SMS grouping** menu:
 - a. Assign the selected GSM modules to the SMS groups (according to the GSM provider and SIM cards with identical tariffs, for example).
 - b. Assign the SMS groups created in step 1.a above to the User groups if you use messaging with different routing rules to different company departments, for example.
2. Add users in the **Messaging / Users / Add** menu:
 - a. Assign the user to a **User group**.
 - b. Set **Access type: SMPP (SMSC)**.
 - c. Set **System ID** and **Password** to access the GSM gateway SMS server via ESME.
 - d. Set **TCP type: server**.
3. Create the incoming SMS routing rules in the **Messaging / User Group / General settings / Incoming SMS routing / Add** menu:
 - a. Select the group to receive the SMS via the **Message from SMS group** menu.
 - b. Select the **Action type** to define how to process incoming SMS. Example: Set **Action type: Deliver to user** to deliver SMS to selected users.
 - c. Set **Deliver to user** to define the SMS receiving user.

4. Create the outgoing SMS routing rules in the **Messaging / User Group / General settings / Outgoing SMS routing / Add** menu:
Enable the SMS server in the **Messaging / Modules grouping / SMS server enabled** menu.
 - a. Set the **SMS group** via which the outgoing SMS will be routed in the **Message to SMS group** menu.
 - b. Select the **Action type** to define how to process outgoing SMS. Example: Set **Action type: Submit from user** to send SMS from selected users.
 - c. Set **Submit from user** to define the SMS sending user.

Should you get in troubles, follow the steps below please:

- Read the User Manual carefully and check all parameters.
- Find answers to the frequently asked questions at <http://faq.2n.cz>.
- Consult your servicing partner.

You are recommended to attend a 2N certified training to improve your installation chances.

Monitoring

/This section helps you configure sending of SNMP traps. Download the list of available traps, i.e. the MIB table, from the gateway web interface. The main purpose of SNMP monitoring is to observe your GSM gateway states continuously and send state information to the defined IP addresses whenever an error occurs.

Refer to the **List of SNMP traps** for the list of all SNMP traps sent by **2N® BRI**.

⚠ Caution

- This service is subject to licence! Refer to **Management / Licence key** for the current GSM gateway licence state details.

✔ Tip

- You can also apply ISDN monitoring to monitor the ISDN PRI line state. Refer to Gateway **Configuration / ISDN Parameters – Monitoring** for details.

Common Settings

General

- **Signal level** – define the maximum/minimum level of the signal received by the GSM/UMTS module. The SNMP trap is sent automatically whenever the defined values are exceeded.
- **SMS bufer upper limit** – define the maximum filling capacity of the SMS storage. The SNMP trap is sent automatically whenever the defined value is exceeded.

Common settings

General

Signal lower / upper limit: -51 dBm / -51 dBm

SMS buffer upper limit: 10%

SNMP

General

- **Enabled** – enable/disable the SNMP service.
- **Community** – SNMP community is a group that owns the device and control stations on which SNMP is running. Default value = public.

Servers

- **First SNMP server** – the addressee's primary IP address and transport port for SNMP traps (default port = 162). Please make sure that the parameters have been completed correctly to avoid SNMP malfunction.
- **Second SNMP server** – the addressee's secondary IP address and transport port for SNMP traps (default port = 162). If these parameters are correctly completed, the SNMP traps will be sent both to the primary and secondary IP addresses.

Download MIB files

This section helps you download the MIB files that are necessary for a proper function of your MIB browser.

SNMP

General

Enabled:

Community:

Servers

First SNMP server:	<input type="text" value="192.168.22.138"/>	: <input type="text" value="162"/>	Set default port
Second SNMP server:	<input type="text" value="0.0.0.0"/>	: <input type="text" value="162"/>	Set default port

Download MIB files

[TEL2N-MIB.txt](#)

[TEL2N-TC-MIB.txt](#)

[BRI-MIB.txt](#)



Caution

The SNMP service works properly on condition that:

- SNMP is licensed in the **Management** section.
- The primary IP address, transport port and community parameters are completed.
- SNMP is enabled in the **Monitoring** section.e

List of SNMP traps

Type	Text
VoIP	VoIP SIP line is not registered
	VoIP SIP line is registered
BRI	BRI 1 link unplugged, layer1 deactivated
	BRI 1 link plugged in, layer1 activated
	BRI 1 link layer 2 not established
	BRI 1 link layer 2 established
	BRI 2 link unplugged, layer1 deactivated
	BRI 2 link plugged in, layer1 activated
	BRI 2 link layer 2 not established
	BRI 2 link layer 2 established
GSM	First GSM module: ERROR
	First GSM module: OK
	First GSM module has too strong signal level
	First GSM module decreased under level of too strong signal level
	First GSM module has weak signal level
	First GSM module increased over level of too weak signal level
	Second GSM module: ERROR
	Second GSM module: OK
	Second GSM module has too strong signal level
	Second GSM module decreased under level of too strong signal level
	Second GSM module has weak signal level
	Second GSM module increased over level of too weak signal level
SMS buffer	Number of SMS/SMPP messages in memory exceeds defined max level
	Number of SMS/SMPP messages in memory decreased under defined max level
	Number of SMS/SMPP messages in memory exceeds defined max level
	Number of SMS/SMPP messages in memory decreased under defined max level

Utils

This section provides extra functions of the GSM gateway. At present, the GSM gateway offers the Ethernet interface tracing (Network trace) and gateway communication tracing functions. These functions help detect gateway installation troubles (SIP communication debugging). The file format is PCAP, which is readable in the Wireshark (<http://www.wireshark.org/>) program, for example.

BTS Lock

This section helps you set the BTS lock if the GSM/UMTS module supports this function. The BTS ID containing cells are marked blue to indicate that the module supports BTS. Set the BTS lock manually by selecting a BTS or depending on the BTS signal intensity.

Send USSD Command

This section helps you send USSD commands to a mobile network and display subsequent replies.

Tip

- The USSD menu helps you, for example, obtain SIM credit or other information from the provider. The USSD menu can contain multiple levels. Use the semicolon ';' to access the next level. A USSD command can be as follows, e.g.: ***123#;1;2**.

Test Call

This section helps you test calls via the gateway interfaces or verify the LCR settings. Both incoming and outgoing calls to/from all the **2N[®] BRI** interfaces can be tested.

Status

- **Call status Connection channel** – display the channel for the selected interface for outgoing test calls.
 - **NULL** – no action.
 - **CPRES** – call setup request.
 - **IPROC** – call setup initiation.
 - **CRECV** – called user ringing.
 - **ACTIVE** – active call.
 - **DISREQ** – call end request.
 - **OVRECV** – call setup request rejection due to non-fulfilment of the LCR conditions.
- **Waiting channel** – display the test channel for an incoming call via the selected **2N[®] BRI** interface.

Control

- **Action type** – set the test call type.
 - **Make call** – the gateway will make an outgoing test call.
 - **Wait call** – the gateway will await an incoming test call.
- **Destination channel** – select a channel for the outgoing call interface. The LCR settings do not affect the call.
- **Source channel** – select the source channel for the outgoing call interface. Only if **Destination channel - According to LCR** is used.
- **Wait on channel** – select the channel for the incoming call interface.
- **Dial** – called number.
- **Clip** – calling number.

Management

Firmware Update

This section helps you upgrade your GSM gateway firmware. Select the BRI-xx.xx.xx.bin files only. Refer to [Subs 4.3](#)

 **Warning**

- Use the **firmware certified** for this GSM gateway type only to avoid **irreversible damage** to your system!

When the new firmware file has been uploaded successfully, the GSM gateway will be restarted automatically.

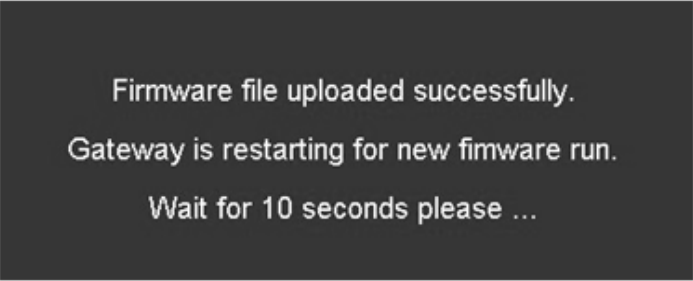

Firmware file uploaded successfully.
Gateway is restarting for new firmware run.
Wait for 10 seconds please ...

Licence key

This section helps you upload the licence file/code to **2N[®] BRI** and provides information on the current licence file. Refer to [Gateway Control](#) for more details.

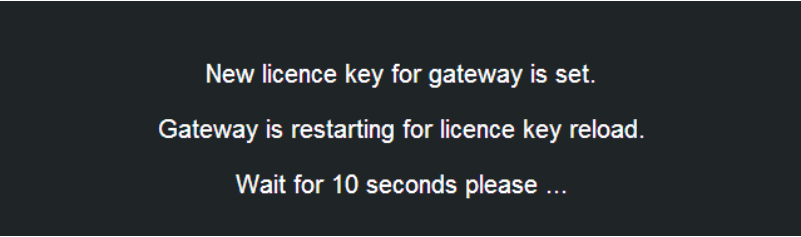

New licence key for gateway is set.
Gateway is restarting for licence key reload.
Wait for 10 seconds please ...

 **Caution**

- By inserting a new licence code you restart the GSM gateway and discontinue all the currently made calls!

Restart

This section provides forced restart of the BRI gateway connected.

Gateway is restarting.
Wait for 10 seconds please ...

Configuration download

Use this window to download the current BRI gateway configuration. The saved file has the following format: CFG-M202-gateway_serial_number-rrrrmmdd-hhmmss.tar

Configuration upload

Use this window to upload new configuration to the BRI gateway. The Ethernet interface values and access data remain unchanged!

Warning

- Upload a well-known configuration file intended for the selected GSM gateway to avoid GSM gateway error and subsequent factory restart.

Configuration Reset

This subsection helps you restore the default configuration (except for Ethernet and login).

- **Including LCR table** – enable/disable keeping of the LCR table records .
- **Including CLIP routing table** – enable/disable keeping of the CLIP routing table records.

Documentation

Download the User Manual saved in the gateway.

Caution

- The User Manual version will not change during the gateway firmware upgrade. Click on the link to www.2n.cz for the latest User Manual version!

Others

SMS

This subsection helps you send and receive SMS via the modules.

 **Tip**

- You can also use the SMS user account for SMS sending/receiving. Refer to the Web Configuration subsection for SMS user configuration details.

 **Note**

- This menu is inactive if the SMTP/POP3 or SMPP messaging licence is active. In this case, use the **Messaging / Send SMS** menu for sending SMS via the web interface.

6. Advanced Configuration

Communication with the **2N[®] BRI Enterprise / BRI Lite** gateway is via the LAN. This connection provides uniform gateway configuring by AT commands.

Here is what you can find in this section:

- [6.1 LAN Communication Setting](#)
- [6.2 GSM Gateway Behaviour](#)
- [6.3 List of Terminal AT Commands](#)
- [6.4 Status Messages](#)
- [6.5 LOG Files](#)
- [6.6 Call Data Records \(CDR\)](#)
- [6.7 SMS Data Records \(SDR\)](#)
- [6.8 Statistics - Description](#)

6.1 LAN Communication Setting

First set the **2N BRI gateway** IP address to communicate with the gateway via your LAN successfully. To do so, configure the Ethernet interface; refer to [Subs.4.1](#). Use any of the available programs (HyperTerminal, Telnet, Putty, etc.) for communication and configuration with the following data:

- IP address: address set by you
- Port: 23 (Telnet)

6.2 GSM Gateway Behaviour

The gateway behaves as an ANSI terminal with echo. Commands are entered in the text format. Upon login, the gateway reports itself with **OK**. If not, enter the **at** command and press <ENTER>. A correctly connected gateway should answer **OK**. In such case, the gateway starts communicating with a dialogue shown in the figure below. Enter the user name, press <ENTER> and, when being asked so, enter the access **Password**.

```
[ BRI Enterprise ] V-1.5.0.7.0 B-1.0  
Date/time: 10.9.2012/17:55:23.53  
SNumber: M203-5405540001
```

Login:

6.3 List of Terminal AT Commands

By default, all these commands start with AT. (Note: Some of the AT commands listed below may not be available in the current firmware versions.)

Basic AT Commands

The following command list is intended for all GSM gateways from **2N**[®] that are based on the same SW architecture. Some of the AT commands may be inaccessible for the BRI gateways.

- **A/** – repeat last command (without AT)
- **I3** – copyright & firmware
- **I4** – serial number
- **&FRES** – factory defaults & reset
- **&V** – view active parameters (system)
- **&VI** – view active parameters (isdn)
- **&VO** – view active parameters (common)
- **&V#** – view active parameters (modules 1..2)
- **&V9** – view active parameters (inc. groups)
- **&VALL** – view all group parameters
- **&VE** – Overview of VOIP parameters
- **&P** – view pseudo params
- **&N#** – view network params (net 1..8)
- **&NALL** – view all network params
- **&A** – view autorouting table <SPACE...continue>
- **&R** – view lcr-routing table <SPACE...continue>
- **&T** – view bris + modules totals
- **&TMOD** – view all modules totals
- **&G##=atcommand** – send at command to module 0..1 (ended by OK from gsm)
- **&G##=xtcommand** – send at command to module 0..1 (ended by <CR> from user)
- **&G##=cmd** – cmd for module 0..1 (RESET,BLOCK,OFF,DOWN,ON), (ATBAUD)
- **&GALL=cmd** – cmd for module 0..1 (RESET,BLOCK,OFF,DOWN,ON)
- **&S** – view aux, bris, modules status
- **&S##** – view aux, bris, one module status (ax,px,ex,0..1)
- **&S=info** – view all modules selected info (by at&S##)
- **&Q##** – view signal quality on module 0..1
- **&QALL** – view signal quality on all modules
- **&L** – view logfile from recent <SPACE...continue>
- **&C** – view buffer (calls) from recent <SPACE...continue>
- **&CR** – read buffer (calls) from the oldest <#...erase & continue>
- **&CS** – view buffer (SMS) from recent <SPACE...continue>
- **&CSR** – read buffer (SMS) from the oldest <#...erase & continue>
- **&BSYS=cmd** – cmd for system (RESET)
- **&XG** – view conn table/gsm (call states)
- **&XG##** – view call details for gsm channel)
- **&M0** – disable ansi colors
- **&M1** – enable ansi colors
- **&M9** – start matrix
- **&U** – view logged users
- **&I##** – view gsm moninfo (dBm = signal level whn registering with BTS,
- **RxLEV** = minimum signal level required by BTS for registering of GSM module)

Configuration AT Commands

System Settings

- **%S85=sms** - no answer sms text (max 63 chars)
- **%S90=mode** - operating mode of GSM module allocation
 - (0=cyclic mode, 1=locked mode, 2=smart mode - according to already called minutes)
 - (for 0 and 2 set LCR group = 3 (any))
- **%S91=buf,id** - cdr mode (b0=outg, b1=inc, b2=failed, b3=moninfo)
 - unit id (0=off, 1..255)
- **%S92=rep** - report mode (b0=states, b1=tstamp, b2=smp, b3=lay2, b4=select)
- **%S98=pin** - sim pin (max 7 digits)
- **%S99=dd.mm.yy.w/hh:mm:ss** - set date/time (w=1..7 day of week)
- **%X10=tsec** - external routing tout in sec/10 (5..60,255)
- **%X20=mmdd,mmdd** - date of hour+1, hour-1 time change (0=off, 0101..1231)
- **%X22=hh:mm** - 0:01..23:59...time of reset of GSM gateway, 0:00 - no reset
- **%X80=login/pass** - login name / password (max 15 chars all)

System Control

- **AT&Gxx=RESET** - Reset of GSM module No xx
- **AT&Gxx=BLOCK** - Block of GSM module No xx
- **AT&Gxx=DOWN** - Transfer of GSM module into the sleep mode
- **AT&Gxx=ON** - Transfer of GSM module into the idle mode

ISDN Settings

- **%I00=xxx** – pri1 protocol/mode:
 - NT,TE,NT/S,NTNT (pri2 = TE,NT,SY,NT)
 - For FW:2_03_15 only NT and NT/S (sync received from TE port)
- **%I01=tei,mtp tei,mtp = 0..63,0** – .fixed tei,ptp
 - tei,mtp = 64,0 – .dynamic tei,ptp
 - tei,mtp = 64,1 – .fixed tei,mtp
- **%I05=c1,c2,c3,c4** – cause codes for failed calls
 - c1=dial timeout (TIMEOUT=120)
 - c2=dis.prefix (REJECT=21)
 - c3=req.mod/grp not ready (TEMPFAIL=41)
 - c4=pref grps not ready (CONGEST=42)
- **%I06=sack,proc,prog,ale** – prog.elem (0=off,1..8) for isdn message
- **%I07=opx,npv** – list of old/new prefixes (max 47 chars)
- **%I08=dial,ring,disc** – dial (0 = off,1..255) dialtone to NT on empty SETUP, ring (0=off,1 ..255) ringtone to NT if no PROGRESS from PSTN
 - 1=EU (dial = constantly 425Hz,ring = 1000+4000msec 425Hz)
 - 2=CZ (dial = 300/300/600/1200msec 425Hz,ring = 1000+4000msec 425Hz)
 - 3=HU (dial = constantly 425Hz,ring = 1000+4000msec 425Hz)
 - 4=GB (dial = constantly 425Hz,ring = 400+200+400+2000msec 400+450Hz)
 - disc(0=off,1..255) busy tone to NT interface on DISCONNECT
- **%I09=day,bits,enb** – day (0=off,1..31) of clearing pri stat
 - ctrl bits (b0=not defined, b1=not defined ,b2=subaddr-recv, b4=don't send CONNECT_ACK in TE mode)
 - enblock digits (0=overlap,1..20)
- **%I11=xxx** – dial for dig.call from pri1 (max 15 chars)
- **%I21=xxx** – dial for dig.call from pri2 (max 15 chars)
- **%I127=msn** – MSN number for TE mode
- **%i28=pin (max 15chars)** – PIN (password) for TE->GSM calls

GSM Settings

- **%G02=mode,atms,afms** - tc35 mode (2,4)
 - atms/afms gain (+5dB=3,+2.5dB=1,0dB=0,-2.5dB=2,-5dB=4)
- **%G05=delay** - dtmf space delay (1..99 sec/100)
- **%G06=mmdd,..mmdd** - holiday list (0101=1st jan, 1231=31st dec)
- **%G07=mmdd,..mmdd** - holiday list2
- **%G08=delay,min,max,tout** - gsm call delay (0..10 sec), dial min/max (0..20)
 - dial tout (0..20 sec)
- **%G09=bits,dial,ring** - bit0=sim card number (0=imsi,1=scid)
 - bit1=siemens connecting tone,
 - bit2=don't send CLIP for calls BRI<-GSM
 - bit3=send AoC for calls BRI->GSM (functionless for FW>2.03.14 and lower)
 - dial (0=off,1..255) dialtone to GSM, ring(0=off,1..255) ringtone to GSM if no PROGRESS from PBX
 - ring 1=EU (dial = constantly 425Hz,ring = 1000+4000msec 425Hz)
 - ring 2=CZ (dial = 300/300/600/1200msec 425Hz, ring = 1000+4000msec 425Hz)
 - ring 3=HU (dial = constantly 425Hz, ring = 1000+4000msec 425Hz)
 - ring 4=GB (dial = constantly 425Hz,ring = 400+200+400+2000msec 400+450Hz)
- **%G101=old/new** - gsm causes change table (0..8 causes)
- **%G#1=netid,clir,min,sms,day,sec,sec2,pseudo** - out.module 1..2, sim 1 params
 - netid (7 chars), clir (0=netw,1=on,2=off)
 - min (0=off,1..65535 minutes), sms (0=off,1..65535)
 - day (0=off,1..31,32=everyday), sec/2 (1..250)
 - pseudo (0=off,1..8)
- **%G#9=ale,conn,disc,day,bits,nasms** - alerting tout (0=off,1=send ALERTING on receiving +CIEV from GSM network, 2..20sec after receiving PROCEEDING)
 - conn delay (0..20sec),
 - forced disc (bit0=sim limit, bit1=time limit, bit2=noale)
 - day (0=off,1..31) of clearing group stat,
 - bits 0..255, b0=(unused), b1=min-->calls, b2=(unused)
 - b3=(unused),
 - nasms tout (0=off, 1..20sec)
- **%G9#=mode,min,max,tout,day,dial,clip** - inc.module 1..2 params
 - mode (0=reject,1=ignore,2=ok-message,3=ok-tone)
 - mode (4..7=0..3 + autocallback, 6..7= + ext.callback)
 - min(0..20), max(0..20) tout (0..20 sec) dtmf dial-in
 - day (0=off,1..31) of clearing inc.group stat
 - dial prefix (max 15 ch), clip prefix (max 7 ch)
- **%G9#=xxx,xxx,...xxx** - auto dials (max 63 chars) #=5..8 for inc.groups 1..4
- **%G99=exp,bits** - dynamic clip expire (0=off,1..240 hours)
 - bit0=add.conn, bit1=rem.answ
- **%G19#=mess** - params #=1..4 for inc.groups 1..4
 - mess duration (0=once, 1..99=repeated) minutes

Network List Parameters

- **%N#0=opx/npX** – list of old/new main–prefixes (max 47 chars)
- **%N#1=pref/dig** – list of prefixes/digits–to–end (max 63 chars)
- **%N#2=pref/dig** – pref. list extension (max 63 chars)
- **%N#3=pref/dig** – pref. list extension (max 63 chars)
- **%N#4=pref/dig** – pref. list extension (max 63 chars)
- **%N#5=pref/dig** – pref. list extension (max 63 chars)
- **%N#6=pref/dig** – pref. list extension (max 63 chars)
- **%N#7=pref/dig** – pref. list extension (max 63 chars)
- **%N#9=netid,max** – network id (7 chars), default max digits (0..20)

Routing Parameters

- **%A##=clip,dial,limit** – set autorouting item (ix 0..95)
 - clip (20), dial(20), limit(0=off,1..99 minutes)
- **%R##=net,hh:mm/hh:mm/w+-,groups,lim** – set lcr–routing item (ix 0..63)
 - net (1..8), groups = (max 7 chars=1..3,9), 3=any module, 9=bri2
 - call limit (0=off, 1..99min)
 - last LCR table line must be empty
- **; totals**
- **; first m,c,s** – inc. minutes,calls,smses
- **; second m,c,s** – out. minutes,calls,smses
- **; ri,ro** – redirected inc,out calls
- **%TB#=m,c,m,c** – init minutes,calls in bri # (0..65535)
- **%TBALL=m,c,m,c** – init minutes,calls in all bris (0..65535)
- **%TG#=m,c,ri,ro** – init minutes,calls,rin,rout in group # (0..65535)
- **%TGALL=m,c,ri,ro** – init minutes,calls,rin,rout in all groups (0..65535)
- **%TI#=m,c** – init minutes,calls in inc.group # (0..65535)
- **%TIALL=m,c** – init minutes,calls in all inc.groups (0..65535)
- **%T##=1,m,c,s,m,c,s** – init minutes,calls,sms in mod ##, sim 1 (0..65535)
- **%TALL=1,m,c,s,m,c,s** – init minutes,calls,sms in all mods, sim 1 (0..65535)

Tracing Commands

- **AT!RE** – Start tracing of error messages active interface.
- **AT!Lx** – Start tracing of LAN & Telnet on layer xx=2 – Layers IP,TCP,Telnet x=3 – Layers TCP, Telnetx=4 – Layer Telnet
- **AT!Rx** – Start tracing of ISDN BRI & GSM on layer xx=1 – Layers 1,2,3,4x=2 – Layers 2,3,4x=3 – Layers 3,4x=4 – Layer 4
- **AT!RR** – Start tracing (AT!R2) to COM1 interface
- **AT!RX** – Stop tracing (AT!R2) to COM1 interface

SMS Processing

SMS Sending/Receiving Commands

- **AT!G=A6** – Start low–level controlling for SMS (can run only on one port)
- **AT!G=55** – Stop low–level controlling on used port

Control SMS

- **AT^SX=ch** – (sms listing) request to list all SMS messages and status confirmations saved on SIM card. Possible answers: *smserr (busy,list) or *smsinc (ix=1..255) for each saved SMS or status SMS messages, end of list or empty SIM card – *smsinc (ix=0).
- **AT^SR=ch,ix** – (sms read) request to read SMS or status SMS saved in SIM card. Possible answers: *smserr (busy,read) or *smspdu
- **AT^SD=ch,ix** – (sms delete) request to delete SMS message (or status SMS message). Possible answers: *smserr (busy,delete) or *smsdel
- **AT^SM=ch,len,pdu,csum** – (sms to module) request to send message via GSM module 0..31 or via any GSM module (ch=32). Possible answers: *smserr (busy,write) or *smsout
- **AT^SG=grp,len,pdu,csum** – (sms to group) request to send SMS message via GSM group 1..8. Possible answers: *smserr (busy,write) or *smsout

SMS from BRI GSM Gateway

- ***smsinc: ch,ix,sts** – SMS message was received and saved into SIM card:
 - Ch...GSM module number 0..31
 - Ix...index number of saved SMS 0..255
 - Sts...SMS status
- ***smsrep: ch,ix** – SMS status confirmation was received and saved to SIM card (this message is only for GSM modules TC35 and GM47)
- ***smsout: ch,ix,ref** – SMS message was sent and was not saved into SIM card:
 - Ref...reference number of sent SMS 0..255 (will be used in SMS status confirmation message)
- ***smspdu: ch,ix,sts,len,pdu,csum** – content of SMS message or status confirmation:
 - Len...SMS length (number of bytes in PDU)
 - Pdu...message content in PDU format
 - Csum...Checksum of all PDU bytes (2 hexa digits) calculated without carry
- ***smsdel: ch,ix** – SMS message or status confirmation was deleted from position ix

6.4 Status Messages

ISDN Layer 1 Message Status

ID	Name	Description
0	DEACT	Deactivation – no signal received
1	ACTIVE	Activation – full synchronisation achieved (frame,multiframe,crc)
2	SIGNAL	Signal received – no synchronization
3	SYNC	Signal received – only partial synchronization (frame)

ISDN Layer 2 Message Status

ID	Name	Name acc. to ITU-T Q.921
0	NOTEI	TEI Unassigned
1	AWTEI	Assigned Awaiting TEI
2	AWTEST	Establish Awaiting TEI
3	OKTEI	TEI Assigned
4	AWEST	Awaiting Establishment
5	AWREL	Awaiting Release
6	OKEST	Multiple Frame Established
7	TIMREC	Timer Recovery

ISDN Layer 3 Message Status

ID	Name	Name acc. to Q.931	Description on NT interface	Description on TE interface
0	NULL	Null	Rest status, ready for call	
1	CINIT	Call Initiated	Call from BRI indicated	Call to BRI started
2	OVSEND	Overlap Sending	Gradual dialling receiving	Gradual dialling sending
3	OPROC	Outgoing Call Proceeding	Dialling from BRI terminated	Dialling to BRI terminated
4	CDELIV	Call Delivered	Call from BRI ringing	Call to BRI ringing
6	CPRES	Call Present	Call to BRI started	Call from BRI indicated
7	CRECV	Call Received	Call to BRI ringing	Call from BRI ringing
8	CONREQ	Connect Request	Call to BRI answered	Call from BRI answered
9	IPROC	Incoming Call Proceeding	Dialling to BRI terminated	Dialling from BRI terminated
10	ACTIVE	Active	Connected call	
11	DISREQ	Disconnect Request	End of call from BRI	End of call to BRI
12	DISIND	Disconnect Indication	End of call to BRI	End of call from BRI
19	RELREQ	Release Request	Channel release request	
25	OVRECV	Overlap Receiving	Gradual dialling sending	Gradual dialling receiving
61	RSTREQ	Restart Request	Channel restart request sent	
62	RSTART	Restart	Channel restart request received	

Management Message Status

ID	Name	Description
0	INIT	Initialization upon BRI reset
1	IDLE	Activation – rest status, necessary for layers 2 and 3
2	DISC	Deactivation

GSM Layer Statuses

GSM Layer 2 Message Status

ID	Name	Description	Follows
0	INIT	GSM module initialization start	PINREQ
1	SIM0	Module switch to internal SIM card	INIT
2	PINREQ	Module PIN request	PINSET
3	PINSET	PIN value sensing to module	INFO
4	BLOCK	Module blocked temporarily or permanently (see Layer 2 information)	INIT
5	SETUP	Module configuration running	IDLE
6	SLEEP	Module sleep running (transition to BLOCK status)	BLOCK
7	NWAIT	Awaiting GSM log-in	SETUP
8	IDLE	Rest status, can start/receive call, execute AT&G command	CALL/CMD
9	CALL	Call running (call establishing, connected call, call end)	IDLE
10	CMD	Communicating with module upon AT&G command	IDLE
13	INFO	Information loading from module and SIM card	NWAIT

GSM Layer 2 BLOCK Message Status

ID	Name	Description
41	(block)	Blocked by AT&G command, terminated by module, board or system reset
42	Netw-reg	GSM log-in refused (not activated SIM), next attempt in 5..60 minutes
43	Clir-err	CLIR activation request refused, next attempt in 2..10 minutes
44	Mod-err	Defective or not connected GSM module, next attempt in 2 minutes
45	Pin-err	Wrong PIN, permanently in BLOCK status
46	Sim-err	Defective or not inserted SIM card, next attempt in 2 minutes
47	Log-out	Temporarily logged-out according to parameter X00
48	Puk-req	SIM card requires PUK
	(undef)	This position of SIM card wasn't checked by gateway

GSM Layer 3 Message Status

ID	Name	Description
0	NULL	Rest status, ready for call
1	CINIT	Request of call to GSM (from Layer 4)
3	OPROC	Call to GSM is connected
4	CDELIV	Call to GSM is ringing
6	CPRES	Indication of call from GSM (from Layer 2)
7	CRECV	Call from GSM is ringing on ISDN interface
9	IPROC	Call from GSM is processed by ISDN interface
10	ACTIVE	Connected call
11	DISREQ	Disconnection request (to Layer 2)
12	DISIND	Indication of disconnection (from Layer 2)
19	RELREQ	Module release for another call (to Layer 2)
25	OVRECV	Reading of DTMF dialling from GSM (from Layer 2)
38	RELIND	Indication of module release (from Layer2)

Layer 4 Message Status

ID	Name	Description
0	NULL	Rest status, ready for call
1	MORE	Call request received from GSM or ISDN, awaiting further dialling or timeout
2	SETUP	Call request sent to opposite interface
3	PROC	Call request confirmed, awaiting call answer
4	ACTIVE	Connected call
5	DISC	Call disconnection in progress

Command Shell Statuses

Command Row Message Status

ID	Name	Description
0	IDLE	Rest status, awaiting AT commands
1	REQUEST	Communication with GSM module upon AT&G command is displayed
2	REPORT	Active tracing
3	LOGFILE	Content of log file is being written out
4	CALLFILE	Content of call file is being written out
5	CALLREAD	Call file records are read
6	AUTOFILE	Content of incoming call autorouting chart is being written out
7	QUERY	(not used so far)
8	SCREEN	(not used so far)
9	MATRIX	Active matrix screensaver
10	FUNCFILE	Content of debug file is being written out
11	LCRFILE	(not used so far)

Telnet Message Status

ID	Name	Description
0	LOGOUT	User logged-out
1	LOGIN	User is entering name
2	PASSW	User is entering password
3	IDLE	User logged-in

Records of Events and Calls

Records on Events and Calls

ID	Name	Description
0	POWER	System power on, power off or reset
1	INIT	Initialization of EEPROM (configuration) or flash (upgrade)
3	SYSERR	System error (memory error, etc.)
8	L1-ERR	BRI port layer 1 error (ISDN1)
9	L2-ERR	BRI port layer 2 error (ISDN2)
10	L3-ERR	BRI port layer 3 error (ISDN3)
12	G2-ERR	GSM module layer 2 error (gate2)
13	G3-ERR	GSM module layer 3 error (gate3)
14	C4-ERR	Link layer error (call4)

Types of CDRs

ID	Name	Description
0	I-FD	Not connected incoming call attempt
1	I-OK	Connected incoming call
8	O-FD	Not connected outgoing call attempt
9	O-OK	Connected outgoing call

6.5 LOG Files

Description of the table:

Type	Text	Description
POWER	[Power on]	System switched on
	[Power off]	System switched off
	[Warm boot]	Restart of system, unknown cause
	[Watchdog]	Restart of system by watchdog
	[BKPT code]	CPU error: break code detected
	[Stack error]	CPU error: stack integrity failure
	[Divided by zero]	CPU error: dividing by zero
	[RETI code]	CPU error: illegal using of instruction reti
	[NMI intr]	CPU error: wrong interrupt
	[VOID intr]	CPU error: wrong interrupt
	[Upgrade reset]	Start of upgrade firmware procedure
	[Software reset]	Reset by AT commands (at&fres...)
INIT	Eeprom	Initialisation of eeprom (configuration)
	Flash	Initialization of flash memory (firmware)
HW-ERR		(##...address of chip, RD...read value WR...expected value)
	Duart ##### ,RD/WR	Error in initialization of serial controller on GSM board
SYSERR	User stack error!	SW error: stack integrity failure
BRDIN	#08 TYP STS	the board inserted (number of gsm board, type, status)
BRDOUT	#08 TYP STS	the board disconnected
BRDRES	#08 TYP STS	Reset the board by AT command
	ALL GSM RESET CMD	Reset of all GSM boards by AT command
	SYSTEM RESET CMD	Reset of system by command at&bsys
L1-ERR		(reserved)
L2-ERR		Error of 2. ISDN layer by Q.921
	A: unsol.RX(F)	Received packed RR,RNR,REJ with unexpected bit F=1
	B: unsol.DM(F)	Received packed DM with unexpected bit F=1
	C: unsol.UA(F)	Received packed UA with unexpected bit F=1
	D: unsol.UA(-)	Received packed UA with unexpected bit F=0
	E: unsol.DM(-)	Received packed DM with unexpected bit F=0
	F: peer re-est	Received packed SABME in status OKEST
	G: repeated SABME	Repeated unsuccessful send of packet SABME

	H: repeated DM	Repeated unsuccessful send of packet DM
	I: failed (TIMREC)	Unsuccessful breaking-up of status TIMREC
	J: N(R) error	Received wrong value N(R) – numbering of packets
	K: recv.FRMR	Received packed FRMR (information about error)
	L: undef.frame	Received unknown type packed
	M: (I field)	Received wrong I-packet (numbered packet)
	N: frame size	Received packed with wrong length
	O: N201 error	Value N201 was exceeded (max. length of packet)
L3-ERR	tout sts # (p##)	Error of 3. layer isdn: timeout in status # on channel p##
G2-ERR	ATD/ERROR init (g##)	Error of 2. layer isdn: restart of module g## after rejected command ATD by GSM network
	GSM Cause 150 (g##)	Error of 2. layer isdn: restart of module g## after cause 150 was received (call barred by GSM network)
G3-ERR	tout sts # (g##)	Error of 3. layer isdn: timeout in status # on module g##
C4-ERR	tout sts # (p##/g##)	Error of 4. connecting layer: timeout in status # on call between channel p## and GSM module g##

6.6 Call Data Records (CDR)

For the current CDRs see the **Gateway / Gateway control / CDR file** section or use the AT&C / AT&CR AT commands for Telnet sessions.

****Date Time Type Cause From/to Groups conn. durat. aoc-info gid CDN CGN IMSI/SCID**

- **Column 1:** **
- **Column 2:** call date and time
- **Column 3:** call status
 - I-FD : failed incoming call
 - I-OK : successfully connected incoming call
 - O-FD : failed outgoing call
 - O-OK : successfully connected outgoing call
- **Column 4:** GSM release cause
- **Column 5:** used channel number / used GSM module
- **Column 6:** used GSM group (C=CallBack)
- **Column 7:** connection time
- **Column 8:** call duration mmm:ss (max. 255:59), or error cause for unconnected call
- **Column 9:** call cost (to be implemented in higher firmware versions) / gateway ID (optional)
- **Column 10:** called party number (CDN)
- **Column 11:** calling party number (CGN)
- **Column 12:** SIM card slot number / SIM card IMSI or SCID

6.7 SMS Data Records (SDR)

Refer to the **Gateway / Gateway control / SDR file** section for the current SDRs section or use the AT&CS / AT&CSR AT commands for Telnet sessions.

** **date** **time** **type** **error** **usr/gr/mo** **ssec** **date** **time** **pn/pt** **gid**

- **Column 1:** **
- **Column 2:** date/time – SDR record creation time
- **Column 3:** type of SMS
 - R-OK – delivered OK – SMS received
 - S-FD – sending ERROR – SMS sending error
 - S-OK – send OK – SMS was sent but no SMS delivery receipt was required
 - S-TO – sending timeout – SMS was not sent within the set timeout
 - D-ER – delivery ERROR – SMS delivery error
 - D-OK – delivered OK – SMS delivered
 - D-TO – delivery timeout – SMS was not delivered within the set timeout
 - SANS – SMS after successful call
 - SNOS – SMS at no answer
 - SWEB – SMS was sent via web interface
 - SISD – ISDN alert SMS
 - SALV – alive SMS
- **Column 4:** error type
 - for (D-OK): SMS receipt status (typically E – 000)
 - for (D-ER): SMS receipt error code
 - for (S-FD): module +CMS ERROR (typically E – 028)
 - for (S-FD): internal error (E – 902 = no rule to send)
- **Column 4:** user id/SMS group/GSM module
- **Column 5:** SMS sending time
- **Column 6:** date/time
 - First row – SMS sending time or total sending time for all parts of a long SMS
 - Second row – time of SMS adding to the outgoing/incoming SMS database
- **Column 8:** part number/total
- **Column 9:** gateway id

6.8 Statistics - Description

The GSM gateway automatically generates statistic data on all outgoing and incoming calls. These data can be deleted on the user level or through configuration (automatic deletion on a selected day).

Explanation of columns

- **Group/network/module** – type of calls
- **Reset** – date of last reset the statistics
- **Minutes** – number of minutes hhhh:mm:ss, same number converted to time
- **Calls** – number of calls
- **SMS** – number of sent SMS messages
- **Reject** – number of unconnected calls (no available free GSM module-call rejected with cause 41(42))
- **Failed** – number of unconnected calls (rejected by GSM network)
- **C.off** – number of unconnected calls (terminated by calling party)
- **Errors** – number of unconnected calls (wrong requests – disallowed prefix, etc.)
- **Red.in** – number of connected calls (rerouted to this GSM group)
- **Redout** – number of connected calls (rerouted to another GSM group)

Explanation of rows

- **#i1 inc** – incoming group 1
- **#g1 out** – outgoing group 1
- **#b1 inc** – all incoming calls via BRI1
- **#b2 inc** – all incoming calls via BRI2
- **#vi inc** – all incoming calls via VoIP
- **#grpinc** – all incoming calls via GSM/UMTS
- **#b1 out** – all outgoing calls via BRI1
- **#b2 out** – all outgoing calls via BRI2
- **#vi out** – all outgoing calls via VoIP
- **#grpout** – all outgoing calls via GSM/UMTS
- **#m0 inc** – incoming calls via m0 module – local SIM
- **#m0 out** – outgoing calls via m0 module – local SIM
- **#m0 day** – m0 module limit statistics
- **#m0 fre** – m0 module tariff statistics
- **#m0 rem** – remote SIM statistics

Statistics of outgoing and incoming groups

[Statistics of calls in groups]

group (reset) minutes hhhh:mm:ss calls reject failed c.off errors

```
-----
#i1 inc ( 2.01)      0  0:00:00    0   0   0   0   0
#i2 inc ( 2.01)      0  0:00:00    0   0   0   0   0
```

group (reset) minutes hhhh:mm:ss calls reject failed red.in redout

```
-----
#g1 out ( 2.01)    0  0:00:00    0  0  0  0  0
#g2 out ( 2.01)    0  0:00:00    0  0  0  0  0
```

Statistics of incoming calls on all GSM modules

[Statistics of incoming calls on all modules]

```
network (reset)  minutes hhhh:mm:ss  calls reject failed c.offss errors
```

```
-----
#b1 inc ( 0.00)    0  0:00:00    0  0  0  0  0
#b2 inc ( 0.00)    0  0:00:00    0  0  0  0  0
#vi inc ( 0.00)    0  0:00:00    0  0  0  0  0
#grpinc ( 0.00)    0  0:00:00    0  0  0  0  0
```

```
group (reset)   minutes hhhh:mm:ss  calls reject failed c.offss errors
```

```
-----
#i1 inc ( 2.01)    0  0:00:00    0  0  0  0  0
#i2 inc ( 2.01)    0  0:00:00    0  0  0  0  0
```

```
module (reset)  minutes hhhh:mm:ss  calls reject failed c.offss smses
```

```
-----
#m0 inc ( 2.01)    0  0:00:00    0  0  0  0  0
#m1 inc ( 2.01)    0  0:00:00    0  0  0  0  0
```

Statistics of outgoing calls on all modules

[Statistics of outgoing calls on all modules]

```
network (reset)  minutes hhhh:mm:ss  calls reject failed c.offss errors
```

```
-----
#b1 out ( 0.00)    0  0:00:00    0  0  0  0  0
#b2 out ( 0.00)    0  0:00:00    0  0  0  0  0
#vi out ( 0.00)    0  0:00:00    0  0  0  0  0
#grpout ( 0.00)    0  0:00:00    0  0  0  0  0
```

group (reset) minutes hhhh:mm:ss calls reject failed red.in redout

```
-----
#g1 out ( 2.01)      0      0:00:00      0      0      0      0      0
#g2 out ( 2.01)      0      0:00:00      0      0      0      0      0
```

module (reset) minutes hhhh:mm:ss calls reject failed c.offss smses

```
-----
#m0 out ( 2.01)      0      0:00:00      0      0      0      0      0
#m1 out ( 2.01)      0      0:00:00      0      0      0      0      0
```

Statistics of calls on specific GSM modules

[Statistics of calls on module #0]

module (reset) minutes hhhh:mm:ss calls reject failed c.offss smses

```
-----
#m0 inc (12.03)     0      0:00:00      0      0      0      0      0
#m0 rem (12.03)     0      0:00:00      0      0      0      0      0
```

module (reset) minutes hhhh:mm:ss calls reject failed c.offss smses

```
-----
#m0 out (12.03)     0      0:00:00      0      0      0      0      0
#m0 rem (12.03)     0      0:00:00      0      0      0      0      0
```

module (reset) minutes hhhh:mm:ss calls limit

```
-----
#m0 day (12.03)     0      0:00:00      0      0
#m0 rem (12.03)     0      0:00:00      0      0
```

module (reset) min0:ss limit min1:ss limit min2:ss limit min3:ss
limit

#m0 fre (12.03)	0:00:00	0	0:00:00	0	0:00:00	0	0:00:00
0							
#m0 rem (12.03)	0:00:00	0	0:00:00	0	0:00:00	0	0:00:00
0							

7. Technical Parameters

In this section, the technical parameters of the **2N[®] BRI Enterprise / BRI Lite** product are described.

Wireless

- **Mobile network type:** GSM 850/900/1800/1900MHz, UMTS/3G at 800/850/900MHz/2100MHz – according to the module type used
- **SIM card:** Plug-in 3V („small“)
- **Transmission power:** Max. 2W
- **Receiver sensitivity:** –104 dBm

Antennas

- **Frequency:** 850/900/1800/1900/2100 MHz – according to the GSM module type used
- **Impedance:** 50 Ω
- **Maximum output power:** 2 W
- **Antenna connector type:** SMA (male)
- **Count of antennas:** 1 or 2 (depending on the gateway type)
- **Cable length:** 3–10 m or no cable

Power Supply

- **Adapter:** 110–230 V, 50/60 Hz, 12 V DC
- **DC power supply:** 12 V DC / 2 A
- **Supply connector:** DC jack, 2.1 mm

ISDN

- **ISDN NT connection type:**
 - S0, point-to-multipoint
 - S0, point-to-point
- **ISDN TE connection type:**
 - S0, point-to-multipoint
 - S0, point-to-point
- **ISDN protocol:** EuroISDN, DSS-1
- **2N® BRI Lite port count + type:** 1 NT/TE
- **2N® BRI Enterprise port count + type:** 1 NT + 1 TE
- **ISDN connector type:** 2 RJ-45
- **NT interface supply:** From external adapter or ISDN

Ethernet

- **Type:** Ethernet 10/100BaseT
- **Connector:** RJ-45
- **Protocols:** Telnet, http, SIP
- **VoIP signalling:** SIP (TCP, UDP), DTMF RFC2833
- **Voice codecs:** G.711 (A/u-law), G.729ab

Others

- **Dimensions (w/o connectors):** 162 mm x 156 mm x 35 mm
- **Working temperature:** 0°C to 45°C
- **Relative humidity:** 5 to 95%

8. Supplementary Information

This section provides supplementary information on the **2N[®] BRI Enterprise / BRI Lite** product.

Here is what you can find in this section:

- [8.1 Troubleshooting](#)
- [8.2 List of Abbreviations](#)
- [8.3 Directives, Laws and Regulations](#)
- [8.4 General Instructions and Cautions](#)

8.1 Troubleshooting



For the most frequently asked questions refer to faq.2n.cz.

- No LED is shining on **2N® BRI Enterprise / BRI Lite**.
 - **2N® BRI Enterprise / BRI Lite** is disconnected from the power supply.
- **2N® BRI Enterprise / BRI Lite** fails to log in to the GSM network.
 - Check the SIM card.
 - Check the PIN.
 - Check the antenna connection.
 - Select a place with a good GSM signal.
- When I make outgoing call thru the GW, the call is rejected by the gateway. What may cause it?
 - The communication protocol on the line from your PbX to the gateway is set to Euro ISDN DSS1 according to Q.931
 - The SIM cards are logged to the network correctly – both LEDs called GSM1 and GSM2 must be off (they are blinking during logging process, but they go off after they are logged successfully)
 - You see good signal strength in the Diagnostics (between –60dB and –80 dB)
 - The SIM cards are active, they have credit, they are not blocked by the GSM operator
 - If you are using CLIR function Enabled in the gateway, check if this feature is enabled in the SIM card by the GSM operator
 - The dialed number is in correct format, it matches one of the Network Lists and this Network List is Actively used in the LCR section
 - If you have set Max. number of called minutes, make sure those minutes have not been already used up.
 - The Time limitation of SIM card (which part of the day it shall be used) is set correctly
 - Time and Date is set correctly in the Gateway
- Call is not disconnected immediately
 - Call release in GSM network can take up to 2 s. If you are experimenting longer delay it can be caused by gateway or by PBX settings. Usually the connection stays active because of simulation of analogue line. If call is disconnected in analogue line you can hear busy tone. This is not typical anymore in ISDN networks but you can simulate this behaviour and generate busy tone up to 30 s.
 - On gateway side you can set following:

If call stays up when call is disconnected from GSM side. Go to ISDN parameters and set Busy tone on None. (This is turning off busy tone generation from gateway.)

If call stays up when call is disconnected from PBX side. Go to GSM Basic parameters and set Busy tone on None. (This is turning off busy tone generation from gateway). If call is not cut after this settings set this parameter on Disabled. (If PBX requests to keep line active in disconnection message then gateway will ignore this request and the call will be ended)

8.2 List of Abbreviations

List of abbreviations:

- **API** (Application Programming Interface)
- **ASR** (Answer Seizure Ratio)
- **BIOS** (Basic Input-Output System) A basic set of instructions and functions necessary for PC launch.
- **CD** (Compact Disc) A portable optical medium for digital data storing.
- **CDR** (Call Data Record)
- **CLIP** (Calling Line Identification Presentation)
- **CLIR** (Calling Line Identification Restriction) Unknown calling subscriber.
- **COM** PC serial port, RS-232.
- **DHCP** (Dynamic Host Configuration Protocol) Automatic IP address assignment protocol.
- **DNS** (Domain Name Server) Server responsible for transfer between IP addresses and domain names.
- **DTMF** (Dual Tone Multifrequency) Tone dialling.
- **ESME** (External Short Messaging Entity)
- **FW** (Firmware) Similar to SW, used for control microprocessor program name.
- **GMT** (Greenwich Mean Time) Mean time for time zone calculations.
- **GSM** (Group Switched Mobile system) Current digital mobile telephone network standard.
- **GPRS** (General Packet Radio Service) High-speed data transmission with packet commutation in GSM.
- **HW** (Hardware) Electronic equipment, circuit, board and similar components.
- **IMEI** (International Mobile Equipment Identity) Unique number assigned by the GSM module manufacturer.
- **IMSI** (International Mobile Subscriber Identity) Unique SIM card number assigned by the GSM provider.
- **IP** Address of the device within a network.
- **LAN** (Local Area Network)
- **LED** (Light Emitted Diode) Electric light-emitting semi-conductor component.
- **NT** (Network Termination) Network terminal for interconnecting a user line from an ISDN telephone with the provider's external network, a PBX gateway or 2N BRI Enterprise / BRI Lite gateway, for example.
- **PC** (Personal Computer) IBM PC compatible personal computer.
- **PCB** (Printed Circuit Board)
- **PIN** (Personal Identification Number) SIM card code against unauthorised use.
- **POP3** (Post Office Protocol v3)
- **BRI** (Basic Rate Interface) Type of ISDN connection with 2 channels with 64 Kbps each.
- **PUK** (Personal Unblocking Key) Code for SIM card unblocking after repeated PIN entering error.
- **SIM** (Subscriber Identity Module) Modul with a chip for identification in the GSM network.
- **SMPP** (Short Message Peer to Peer)
- **SMSC** (short message service center)
- **SMTP** (Simple Mail Transfer Protocol)
- **SMS** (Short Message Service) Short text message transmitting service in GSM networks. Short text messages.
- **SSH** (Secure Shell) Secured communication protocol for LANs, program.
- **SW** (Software) Program, programové vybavení
- **TCP** (Transmission Control Protocol)
- **TE** (Terminal Equipment) Terminal equipment on the user side (such as ISDN telephone, fax, router, etc.), connected to the NT port only.

- **UCMD** Protocol used for gateway firmware upgrade.
- **UDP** (User Datagram Protocol) Transport layer protocol with non-guaranteed packet delivery.
- **UMTS** (Universal Mobile Telecommunication System) 3G system of the mobile phone standard, successor to GSM.
- **UPS** (Uninterruptible Power Supply) Source of continuous power supply.
- **USSD** (Unstructured Supplementary Service Data) Data transmission standard using GSM signalling channels.

8.3 Directives, Laws and Regulations

Europe

2N® BRI Lite/Enterprise conforms to the following directives and regulations:

Directive 1999/5/EC of the European Parliament and of the Council, of 9 March 1999 – on radio equipment and telecommunications terminal equipment and the mutual recognition of their conformity

Directive 2006/95/EC of the European Parliament and of the Council of 12 December 2006 on the harmonisation of the laws of Member States relating to electrical equipment designed for use within certain voltage limits

Directive 2004/108/EC of the Council of 15 December 2004 on the harmonisation of the laws of Member States relating to electromagnetic compatibility

Commission Regulation (EC) No. 1275/2008, of 17 December 2008, implementing Directive 2005/32/EC of the European Parliament and of the Council with regard to ecodesign requirements for standby and off mode electric power consumption of electrical and electronic household and office equipment

Directive 2011/65/EU of the European Parliament and of the Council of 8 June 2011 on the restriction of the use of certain hazardous substances in electrical and electronic equipment

Regulation (EC) No. 1907/2006 of the European Parliament and of the Council of 18 December 2006 concerning the Registration, Evaluation, Authorisation and Restriction of Chemicals (REACH), establishing a European Chemicals Agency, amending Directive 1999/45/EC and repealing Council Regulation (EEC) No. 793/93 and Commission Regulation (EC) No. 1488/94 as well as Council Directive 76/769/EEC and Commission Directives 91/155/EEC, 93/67/EEC, 93/105/EC and 2000/21/EC

Directive 2012/19/EC of the European Parliament and of the Council of 4 July 2012 on waste electrical and electronic equipment.

8.4 General Instructions and Cautions

Please read this User Manual carefully before using the product. Follow all instructions and recommendations included herein.

Any use of the product that is in contradiction with the instructions provided herein may result in malfunction, damage or destruction of the product.

The manufacturer shall not be liable and responsible for any damage incurred as a result of a use of the product other than that included herein, namely undue application and disobedience of the recommendations and warnings in contradiction herewith.

Any use or connection of the product other than those included herein shall be considered undue and the manufacturer shall not be liable for any consequences arisen as a result of such misconduct.

Moreover, the manufacturer shall not be liable for any damage or destruction of the product incurred as a result of misplacement, incompetent installation and/or undue operation and use of the product in contradiction herewith.

The manufacturer assumes no responsibility for any malfunction, damage or destruction of the product caused by incompetent replacement of parts or due to the use of reproduction parts or components.

The manufacturer shall not be liable and responsible for any loss or damage incurred as a result of a natural disaster or any other unfavourable natural condition.

The manufacturer shall not be held liable for any damage of the product arising during the shipping thereof.

The manufacturer shall not make any warrant with regard to data loss or damage.

The manufacturer shall not be liable and responsible for any direct or indirect damage incurred as a result of a use of the product in contradiction herewith or a failure of the product due to a use in contradiction herewith.

All applicable legal regulations concerning the product installation and use as well as provisions of technical standards on electric installations have to be obeyed. The manufacturer shall not be liable and responsible for damage or destruction of the product or damage incurred by the consumer in case the product is used and handled contrary to the said regulations and provisions.

The consumer shall, at its own expense, obtain software protection of the product. The manufacturer shall not be held liable and responsible for any damage incurred as a result of the use of deficient or substandard security software.

The consumer shall, without delay, change the access password for the product after installation. The manufacturer shall not be held liable or responsible for any damage incurred by the consumer in connection with the use of the original password.

The manufacturer also assumes no responsibility for additional costs incurred by the consumer as a result of making calls using a line with an increased tariff.

Electric Waste and Used Battery Pack Handling



Do not place used electric devices and battery packs into municipal waste containers. An undue disposal thereof might impair the environment!

Deliver your expired electric appliances and battery packs removed from them to dedicated dumpsites or containers or give them back to the dealer or manufacturer for environmental-friendly disposal. The dealer or manufacturer shall take the product back free of charge and without requiring another purchase. Make sure that the devices to be disposed of are complete.

Do not throw battery packs into fire. Battery packs may not be taken into parts or short-circuited either.

**2N TELEKOMUNIKACE a.s.**

Modřanská 621, 143 01 Prague 4, Czech Republic

Phone: +420 261 301 500, Fax: +420 261 301 599

E-mail: sales@2n.cz

Web: www.2n.cz

PR1877v1.13