



2N[®] Indoor Touch



User guide

Firmware: FW 3.4.x

Version: 3.4.x

www.2n.cz

The 2N TELEKOMUNIKACE a.s. is a Czech manufacturer and supplier of telecommunications equipment.



The product family developed by 2N TELEKOMUNIKACE a.s. includes GSM gateways, private branch exchanges (PBX), and door and lift communicators. 2N TELEKOMUNIKACE a.s. has been ranked among the Czech top companies for years and represented a symbol of stability and prosperity on the telecommunications market for almost two decades. At present, we export our products into over 120 countries worldwide and have exclusive distributors on all continents.



2N[®] is a registered trademark of 2N TELEKOMUNIKACE a.s. Any product and/or other names mentioned herein are registered trademarks and/or trademarks or brands protected by law.



2N TELEKOMUNIKACE a.s. administers the FAQ database to help you quickly find information and to answer your questions about 2N products and services. On www.faq.2n.cz you can find information regarding products adjustment and instructions for optimum use and procedures „What to do if...“.



2N TELEKOMUNIKACE a.s. hereby declares that the 2N product complies with all basic requirements and other relevant provisions of the 1999/5/EC directive. For the full wording of the Declaration of Conformity see the CD-ROM (if enclosed) or our website at www.2n.cz.



This device complies with part 15 of the FCC Rules. Operation is subject to the following two conditions: (1) This device may not cause harmful interference, and (2) this device must accept any interference received, including interference that may cause undesired operation.



The 2N TELEKOMUNIKACE a.s. is the holder of the ISO 9001:2009 certificate. All development, production and distribution processes of the company are managed by this standard and guarantee a high quality, technical level and professional aspect of all our products.

Content:

- 1. Product Overview
 - 1.1 Product Description
 - 1.2 Differences between Models
 - 1.3 Terms and Symbols
 - 1.4 Safety Precautions
- 2. Description and Installation
 - 2.1 Before You Start
 - 2.2 Brief Installation Guide
 - 2.3 Installation Conditions
 - 2.4 Status LED
 - 2.5 First Startup
 - 2.6 Home Automation Interoperability
- 3. 2N® Indoor Touch Configuration
 - 3.1 Factory Reset
 - 3.2 Home Screen
 - 3.3 Launcher Configuration
 - 3.4 Device Upgrade

- 4. 2N® IP Mobile Configuration
 - 4.1 2N® IndoorTouch Version
 - 4.1.1 Application Description
 - 4.1.2 Application Environment and Configuration
 - 4.1.2.1 Devices
 - 4.1.2.2 Call Log
 - 4.1.2.3 Dial Pad
 - 4.1.2.4 My2N Mobile Video
 - 4.1.2.5 User Settings
 - 4.1.2.5.1 Basic Settings
 - 4.1.2.5.2 Do Not Disturb (DND)
 - 4.1.2.5.3 Custom Localization
 - 4.1.2.6 Help
 - 4.1.3 Notifications in 2N® Indoor Touch Environment
 - 4.2 Application Use
 - 4.2.1 LAN Calls
 - 4.2.2 SIP Proxy Server Calls
 - 4.2.3 2N® Mobile Video Calls
 - 4.3 Supplementary Information
 - 4.3.1 Troubleshooting

- 5. Web Interface Configuration
 - 5.1 Login
 - 5.2 System Info
 - 5.2.1 Status
 - 5.2.2 Logs
 - 5.3 Device
 - 5.3.1 Network
 - 5.3.2 Home Screen
 - 5.3.3 Local Settings
 - 5.3.4 Display
 - 5.3.5 Audio
 - 5.3.6 Maintenance
 - 5.4 Application
 - 5.4.1 2N® IP Mobile
 - 5.4.1.1 Devices
 - 5.4.1.2 Settings
 - 5.4.1.2.1 Common
 - 5.4.1.2.2 Password
 - 5.4.1.2.3 SIP Proxy
 - 5.4.1.2.4 Video
 - 5.4.1.3 Info
 - 5.4.2 Settings
 - 5.5 Limitations
- 6. Technical Parameters
- 7. Supplementary Information
 - 7.1 Troubleshooting
 - 7.2 Directives, Laws and Regulations - General Instructions and Cautions

1. Product Overview

In this section, we introduce the **2N[®] Indoor Touch** product, outline its application options and highlight the advantages following from its use. The section also includes safety precautions.

Here is what you can find in this section:

- **1.1 Product Description**
- **1.2 Differences between Models**
- **1.3 Terms and Symbols**
- **1.4 Safety Precautions**

1.1 Product Description

Based on the Android OS, **2N[®] Indoor Touch** helps load third party applications to a device (if enabled so in the device configuration), thus improving its flexibility. It contains a 7" colour LCD display with a capacitive touch layer, loudspeaker, microphone and Ethernet and WiFi interfaces (depending on the Part No.) for LAN connection. Analogue inputs and outputs are also part of the equipment.

2N[®] Indoor Touch has a factory pre-installed application - **2N[®] IP Mobile**, which helps establish video calls with any other video call supporting devices (SIP + H.263/4). Primarily, the application is intended for the **2N IP intercom** family.

2N[®] Indoor Touch contains a specific user interface for an increased user comfort and safety.

2N[®] Indoor Touch basic features:

- 7" LCD colour display with capacitive touch layer
- Wall mounting option
- LAN interface with PoE supply option
- 802.11bgn WiFi interface (depending on the Part No.)
- Status RGB LED at front
- Binary inputs and outputs for control of other devices
- Android operating system with pre-installed basic applications and own user interface
- Pre-installed **2N[®] IP Mobile** application

1.2 Differences between Models

This manual is valid for all the 2N[®] Indoor Touch types. Therefore, please note that several features described in this document are only available in selected models or need to be activated with a licence key. If a feature is not available in all the models, a note is added to the respective subsection.

2N[®] Indoor Touch Types

| | |
|---|--|
| <p>Part Nos.:</p> <p>91378365</p> <p>91378366</p>  | <ul style="list-style-type: none"> • 2N[®] Indoor Touch – black • WiFi version (lower Part No.) |
| <p>Part Nos.:</p> <p>91378365WH</p> <p>91378366WH</p>  | <ul style="list-style-type: none"> • 2N[®] Indoor Touch – white • WiFi version (lower Part No.) |

Accessories

Part number:
91378382



- 2N[®] Indoor Touch desk stand black

Part number:
91378382W



- 2N[®] Indoor Touch desk stand white

Part No.:
91378380



- Stabilised 12 V / 2 A source designed for flush mounting box installation. Suitable for installations where PoE supply is unavailable.
- Image is for illustration only, a flush box is not included.

| | |
|--|--|
| <p>Part Nos.:</p> <p>91378381E</p> <p>91378381GB</p> <p>91378381US</p>  | <ul style="list-style-type: none"> • Stabilised 12 V / 2 A source to be used where PoE supply is unavailable. • The part numbers differ in their electric socket markings (E/GB/US). |
|--|--|

Licence

| Part No. | Description |
|----------|--|
| 91378390 | APP - the licence unlocks the installation of third party applications |
| 91378395 | HTTP API - the licence unlocks the HTTP API functions |

1.3 Terms and Symbols

The following symbols and pictograms are used in the manual:

Safety

- Always abide by this information to prevent persons from injury.

Warning

- Always abide by this information to prevent damage to the device.

Caution

- Important information for system functionality.

Tip

- Useful information for quick and efficient functionality.

Note

- Routines or advice for efficient use of the device.

Future Functions, New Features

The grey-marked text in this document designates the functions and features that are under preparation or development at present.

1.4 Safety Precautions

The manufacturer reserves the right to modify the product in order to improve its qualities. The manufacturer continuously responds to the clients' requirements by improving the software. Refer to the www.2n.cz company websites for the latest **device** firmware and User Manual.

- It is prohibited to use any transmitters, including **device** with an internal WiFi adapter, in areas where explosives are used, such as quarries.
- WiFi adapters may affect sensitive life-saving devices in medical centres. Therefore, it is prohibited to use **device** with an internal WiFi adapter in such facilities.
- In general, any RF energy radiation prohibition regarding WiFi antenna equipped devices applies to device with an internal WiFi adapter.
- Where necessary, a **2N[®] Indoor Touch** unit can be installed at a safe distance from the prohibited area and an Ethernet cable can only be carried to the required site.
- Although **2N[®] Indoor Touch** is not intended for cars or aeroplanes, all prohibitions and regulations relating to adapter equipped devices apply to **device** too.

2. Description and Installation

This section describes the **2N[®] Indoor Touch** installation and correct connection.

Here is what you can find in this section:

- **2.1 Before You Start**
- **2.2 Brief Installation Guide**
- **2.3 Installation Conditions**
- **2.4 Status LED**
- **2.5 First Startup**
- **2.6 Home Automation Interoperability**

The device is designed solely for wall mounting. Install the device with the aid of a holder, which is included in the product and Installation Manual delivery.

Prepare the proper wall fittings (screws and wall plugs suitable for the given wall type and structure). Respect the local standards for installation of electronic devices onto flammable materials while mounting!

Use a cross-point screwdriver for tightening the fitting screws on the device sides to place **2N[®] Indoor Touch** properly.

2.1 Before You Start

Product Completeness Check

Please check the 2N[®] Indoor Touch delivery before starting installation:

| | |
|---|--|
| 1 | Indoor Touch |
| 1 | Quick Start manual |
| 1 | Wall holder (screwed to device) |
| 1 | Installation fittings (2 screws, 2 plugs for flush mounting) |

Front Layout

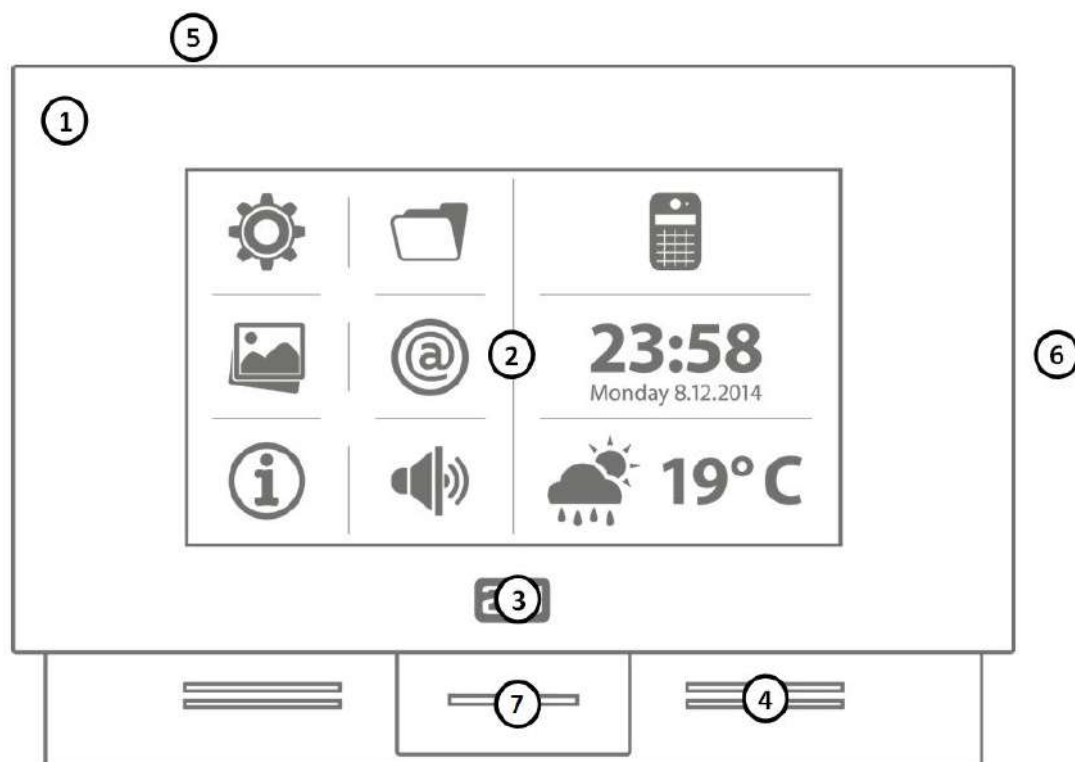

1. Glass frame
2. LCD display with capacitive touch layer
3. Status RGB LED
4. Loudspeaker
5. Microphone
6. micro SD card slot

Backside Connectors

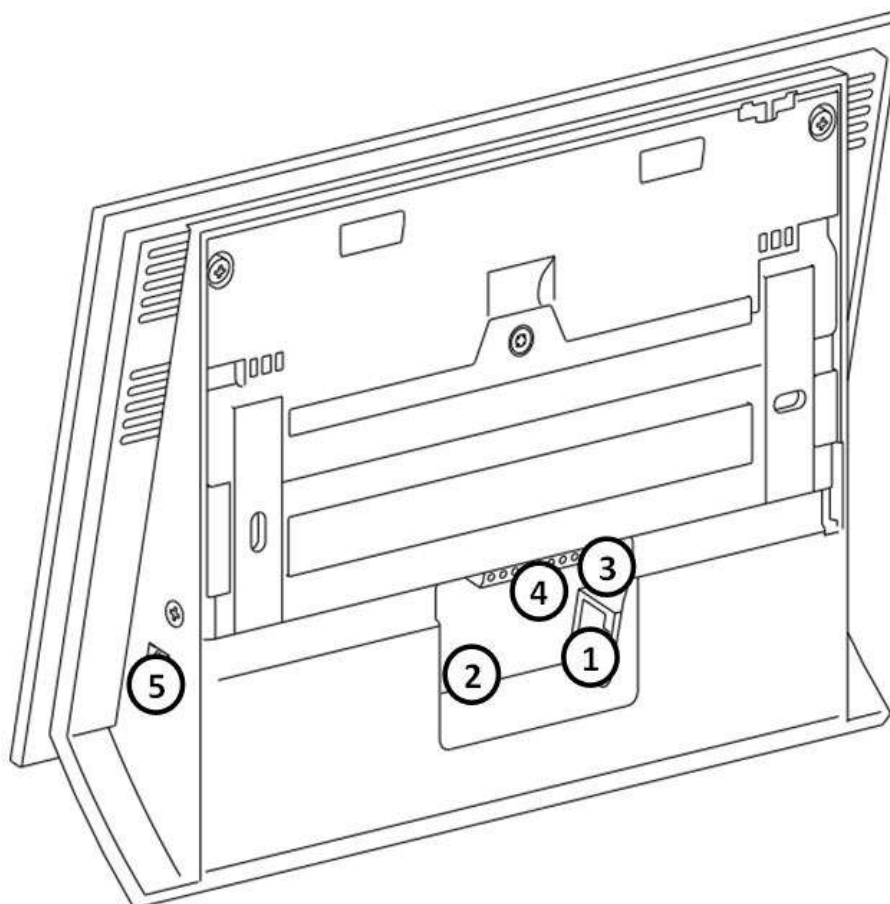

1. RJ-45 LAN 10/100BaseT connector
2. 12 V / 2 A DC supply terminal board (only if PoE is not used)
3. Restart/Factory reset button
4. Binary input/output terminal board (for application control)
5. micro SD card slot

Caution

- Press the Restart button shortly to restart the device. The front panel LED starts shining blue to signal the resetting process.
- Press the Factory reset button for a rather long time (up to 10 s) to factory reset the device. The front panel LED starts shining yellow to signal the resetting process.

✔ **Tip**

- External doorbell button or Relay connection guides are available at faq.2n.cz.

2.2 Brief Installation Guide

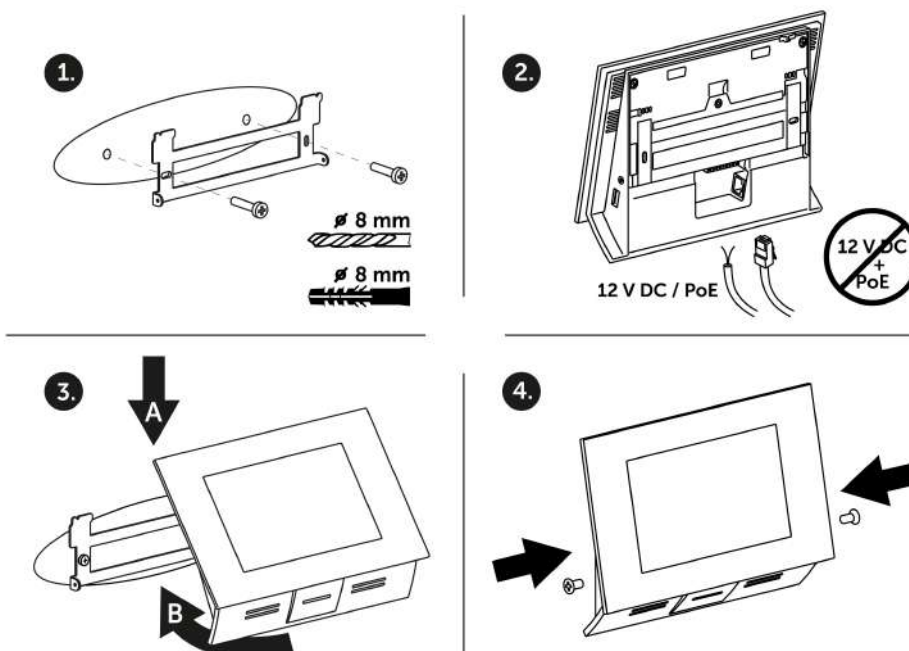

1. Install the device holder onto a vertical wall. The recommended installation height is 120 cm above the floor. The product package includes screws and plugs for mounting into classic bricks. Use appropriate installation fittings for a different type of wall material!
2. Feed the device via an Ethernet PoE adapter (or PoE supporting Ethernet switch /router) or a 12 V / 2 A DC power adapter.
 - a. With PoE supply, just snap RJ-45 into the appropriate connector.
 - b. With 12 V DC 2 A supply, screw the power adapter plus and minus cables into the appropriate terminal board on the device.
 - c. Simultaneous PoE + 12 V / 2 A DC supply is not recommended!
3. Put the device on the holder as follows:
 - a. Place the device carefully from top to bottom with its bottom part slightly away (up to 5 cm) from the wall.
 - b. When the device fits to the main holder supports, push the device bottom part onto the wall.
4. Tighten the safety screws on both the device sides.

2.3 Installation Conditions

Make sure that the following 2N[®] Indoor Touch installation conditions are met:

- There must be enough space for 2N[®] Indoor Touch installation.
- 2N[®] Indoor Touch is designed for vertical wall mounting (perpendicular to the floor) in the height of up to 120 cm above the floor. If necessary, operate **device** in a position other than as aforementioned for a short time only, for quick testing purposes in a servicing centre, for example.
- Exceeding the allowed operating temperature may not affect the device immediately but leads to premature ageing and lower reliability. Refer to **6. Technical Parameters** for the acceptable range of operating temperatures and relative humidity values.
- **Device** is not designed for environments with increased vibrations such as means of transport, machine rooms and so on.
- **Device** is not intended for dusty environments and places with unstable humidity and abrupt temperature changes.
- **Device** may not be exposed to aggressive gas, acid vapours, solvents, etc.
- **Device** is not intended for direct connection into the Ethernet/Internet.
- **Device** must be connected to the Ethernet/Internet via a separating active network element (switch/router).
- **Device** is designed for indoor use. It may not be exposed to rain, flowing water, condensing moisture, fog, etc.
- **Device** cannot be operated on places exposed to direct sunshine and near heat sources.
- Keep some free space above and below **device** to allow air to flow and conduct heat away.
- No strong electromagnetic radiance is allowed on the installation site.
- The VoIP connection must be configured properly according to the SIP and other VoIP recommendations.
- It is recommended that the power adapter be connected to the mains via a UPS and reliable overvoltage protection.

Wall Mounting

2N[®] Indoor Touch is designed for wall mounting. Follow the steps below:

1. Unscrew the holder-fitting screws on the device sides.
2. Turn the metal holder slightly aside in the upper part of the device.
3. Move the holder downwards.
4. Fit the loose holder to the wall on the installation site.
5. Put the device on the holder and tighten the safety screws.

Follow the installation instructions printed on the device package.

Power Supply Connection

You can feed 2N[®] Indoor Touch as follows:

1. Use any 12 V / 2 A DC power adapter connected to the terminal board (see the figure).
2. Use an Ethernet cable connected to a PoE supply or PoE supporting Ethernet switch/router.

A successful operation is indicated by a status RGB LED or LCD display.

PoE Supply Connection

Use a standard straight RJ-45 terminated cable to connect **device** to the Ethernet. The device supports the 10BaseT and 100BaseT protocols. The Ethernet connection state is indicated by the LEDs placed on the RJ-45 connector. Refer to **3.3 Launcher Configuration** for the factory settings of the **device** Ethernet interface.

Caution

- Factory reset results in a change of the Ethernet interface configuration!
- A defective Ethernet cable may lead to a high packet loss in the Ethernet and subsequent instability and poor video call quality!

⚠ Warning

- Connection of a defective or improper power adapter may lead to a temporary or permanent failure of the 2N[®] Indoor Touch unit!

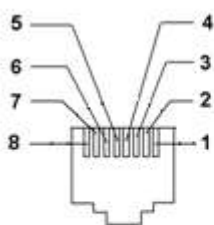
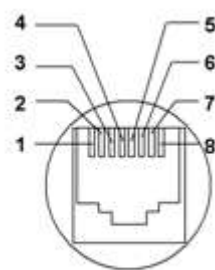
| Ethernet cable connector | Ethernet port |
|---|---|
|  <p> 1 Tx 2 Tx 3 Rx 4 Unused 5 Unused 6 Rx 7 Unused 8 Unused </p> |  <p> 1 Tx 2 Tx 3 Rx 4 Unused 5 Unused 6 Rx 7 Unused 8 Unused </p> |

Licence Limitations

2N[®] Indoor Touch can contain time-limited software licences. Refer to **3.3 Launcher Configuration** for details.

Firmware Upgrade

We recommend you to upgrade the **device** firmware during installation. Refer to **www.2n.cz** for the latest FW version. Refer to **3.4. Device Upgrade** for the firmware upgrade procedure.

2.4 Status LED

Status LED indicates the device states when the LCD display is switched off or the device is in the service mode. See the table below for the LED colours and states:

Device Startup:

| Colour | State |
|--------------------|--------------------------------|
| Blue is on | Device initialisation |
| Red is on | First boot phase |
| Green is on | Operating system start |
| Yellow is on | Factory setting initialisation |
| Blue is flashing | Factory reset |
| Purple is flashing | System upgrade process |
| No light | Device state is displayed |

Standard Operation:

| Colour | State |
|--------------|---|
| No light | Device state is displayed |
| Blue is on | Stand-by mode (display off) |
| Other states | Notification of other states of applications running in the system (2N [®] IP Mobile, e.g.). |

2.5 First Startup

When you start the device for the first time, the initial initialisation (longer start) is performed and indicated by the following LED notification sequence: Blue Red Green Boot animation on the screen Introductory system screen.

The introductory screen provides essential information for User Manual saving /reading. Select "Don't show welcome screen and run **2N[®] IP Mobile** at next start instead" to deactivate this screen for future system startups.

Caution

- If you do not select the "Don't show welcome screen and run **2N[®] IP Mobile** at next start instead" option on the welcome screen before quitting and then enable the **2N[®] IP Mobile** launch after the system startup in the Launcher configuration, the application will not be started for technical reasons. Therefore, be sure to disable the welcome screen start to make **2N[®] IP Mobile** run automatically after the system startup.

The table below shows the factory values of relevant device parameters:

| Parameter | Value |
|----------------------------------|---|
| IP address | will be assigned by the DHCP server |
| IP mask | will be assigned by the DHCP server |
| IP gateway | will be assigned by the DHCP server |
| Access password to configuration | 2n |
| Time/weather location | Prague, CZ |
| Stand-by switching time | 1 minute |
| SW licence | Basic unlimited licence (or according to the Part No.) |



Caution









- Change the access password while configuring the device for the first time to avoid unauthorised access to configuration!

System Licence

2N[®] Indoor Touch has a factory licence key, which can be time-limited (depending on the Part No.). The licence expiry may cause a partial limitation of the device functionality! Refer to **3.3 Launcher Configuration** for the current licence state and licence adding procedure if necessary.

















Home and Building Automation



| Logo | Company | Application to be tested | Version | Interoperability | Notes |
|---|----------|---------------------------------|------------|--|---|
|  | AMX | AMX TPControl | 2.6.4.0 |  | Can be started but fails during SIP calls. Communication with the AMX systems cannot be verified. |
|  | C4 | C4 Mobile | 1.2.6 |  | Can be started but functionality cannot be verified without a device and an account. |
|  | Control4 | Control4 | 2.9.1.2258 |  | Minor graphic problems. |
| | | Control4 MyHome | 2.5.6.8 |  | Functional yet unsupported any more. Replaced by Control4. |
| | | Control4 Composer Express | 2.9.0.59 |  | |
|  | Crestron | Crestron App | 1.02.15 |  (error) | Requires Adobe Air. Fails when VoIP has been set. |

| Logo | Company | Application to be tested | Version | Interoperability | Notes |
|---|---------|---------------------------|------------|--|--|
| | | Crestron Mobile | 1.00.01.42 |  | Landscape has to be forced in Settings. Shows problems without WiFi. |
| | | Crestron AirMedia | 1.0.2.3 |  (error) | Does not work without WiFi. |
| | | Crestron Pyng for Android | 1.0.19 |  | Shows problems without WiFi. |
| | | Crestron PinPoint | 2.2.4 |  (error) | Does not work without the Google Play services. |
| | | Crestron Züm | 1.0.18 |  (error) | Does not support Android 4.4. |
|  | Divus | Divus World | 1.0 |  (error) | Does not work without a Google account. |
| | | Divus IPCamViewer | 1.0 |  (error) | Does not support Android 4.4. |
| | | Divus Optima | 1.1.1 |  | Does not work without WiFi. |
| | | Divus Videophone 4 | 4.1.0 |  (error) | Falls whenever a SIP call is answered. |

| Logo | Company | Application to be tested | Version | Interoperability | Notes |
|---|---------|------------------------------|---------|--|---|
| | | Divus KiBro | 1.2.1 |  | |
| | | Divus Launcher | 1.1.3 |  (error) | 2N [®] Indoor Touch is not a certified Divus device. |
| | | Divus Müllplaner | 1.0 |  (error) | Does not support Android 4.4. |
|  | Fibaro | Fibaro for Tablet | 1.10.0 |  | Does not work without WiFi. |
|  | iNELS | iNELS Home RF Control | 1.0.092 |  | Fails during SIP calls. |
| | | iNELS Home Control Mobile | 0.74 |  | Works with limitations. |
| | | iNELS Home Control RF Mobile | 1.2.031 |  (error) | Wrong graphic user interface layout. |
| | | iNELS Home Control Tablet | 1.39 |  | Works with limitations. |
|  | iRidium | i3 pro | 1.1.5 |  | Works with limitations. |
| | | i3 lite | 1.0.13 |  | |
| | | | | | |

Výsledek obrázku pro iridium mobile

| Logo | Company | Application to be tested | Version | Interoperability | Notes |
|---|---------------------------------|--------------------------|---------|--|-------------------------------|
| | | i2 Control V2.2 | 2.2.5 |  | |
|  | Leviton Security and Automation | Cloud Services | 1.0.7 |  (error) | Cannot be started (error). |
| | | Hi-Fi 2 | 1.0.1 |  | |
|  | Loxone | Loxone Smart Home | 7.4.1 |  | |
|  | RTI | RTiPanel | 1.2.2 |  | |
|  | Savant | Savant | 1.3 |  (error) | Requires Google Play. |
| | | Savant Pro 7 | 7.2.5 |  (error) | Requires Google Play. |
| | | Savant Pro 8 | 8.2 |  (error) | Requires Google Play. |
|  | Schneider Electric | Adapti-M | 1.40.7 |  (error) | Does not support Android 4.4. |
| | | Adapti-G | 1.40.7 |  (error) | Does not support Android 4.4. |
| | | Adapti-C | 1.40.7 |  (error) | Does not support Android 4.4. |
| | | Wiser 1 | 1.0.5 |  | Does not work without WiFi. |

| Logo | Company | Application to be tested | Version | Interoperability | Notes |
|---|---------|--------------------------|---------|---|-------------------------------|
| | | Wiser 2 | 2.04 |  | Does not work without WiFi. |
| | | ULTI Home Control | 1.11.1 |  | Does not work without WiFi. |
| | | InSideControl HD | 2.0.11 |  | Does not work without WiFi. |
| | | homeLYnk Remote | 2.0 |  | Does not work without WiFi. |
|  | xxter | xxter | 2.4.1.2 |  | |
|  | Yönnnet | 42 Life | 1.0.0 |  (error) | Does not support Android 4.4. |
| | | Interra | 1.0.4 |  | |
| | | Interra Pro | 1.1.5 |  (error) | Requires Google Play. |
| | | Interra-2 | 1.0.2 |  | Not supported in English. |
|  | Zipato | Zipato | 4.1.3 |  (error) | Requires Google Play. |
| | | Zipato Intercom | 2.1.0 |  (error) | Requires a Zipato account. |
| | | HDL | 4.1.5 |  | |

| Logo | Company | Application to be tested | Version | Interoperability | Notes |
|------|---------|--------------------------|---------|---|-----------------------|
| | | Domomea | 1.0 |  (error) | Requires Google Play. |

3. 2N[®] Indoor Touch Configuration

This section describes the 2N[®] Indoor Touch configuration.

Here is what you can find in this section:

- 3.1 Factory Reset
- 3.2 Home Screen
- 3.3 Launcher Configuration
- 3.4 Device Upgrade

3.1 Factory Reset

Follow the steps below to reset the 2N[®] Indoor Touch factory values:

1. Push the Factory reset button in the Launcher Configuration menu. Refer to **3.3 Launcher Configuration**.
2. Press and hold the Reset button on the device backside:
 - a. Remove the device from the installation holder.
 - b. Press and hold the Reset button until the notification RGB LED lights up (yellow).
 - c. Release the Reset button and follow the instructions displayed.

 **Caution**

- Factory reset results in a complete deletion of all user data.

3.2 Home Screen

The introductory screen provides a total of nine configurable tiles for you to launch specific, user defined applications. The About and Settings buttons are also available here.

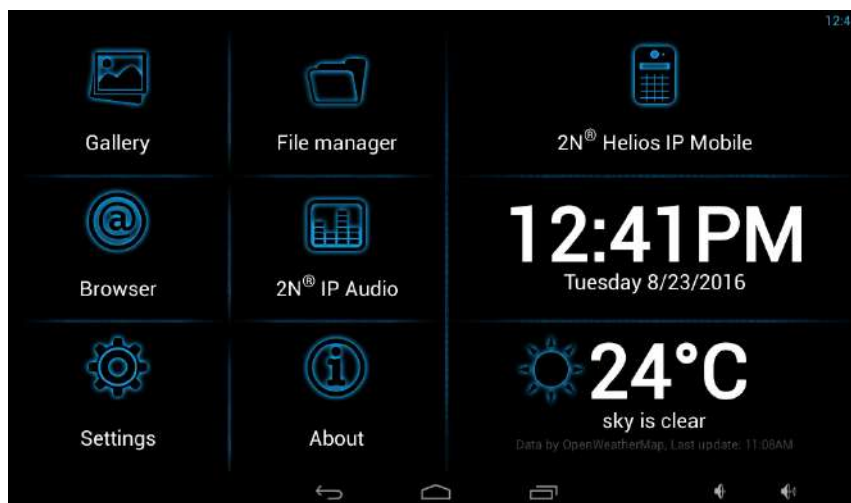

Factory settings:

- **Gallery** - launch the photo/image processing application.
- **File manager** - launch a standard file system application.
- **2N[®] IP Mobile** - video call application; refer to **4. 2N[®] Mobile IP Configuration** for details.
- **Browser** - launch an Internet browser application.
- **2N[®] IP Audio** - remote **2N[®] NetSpeakerserver** control application.
- **Time/Date** tiles
- **Weather** tile
- **About** button
- **Settings** - access to configuration section

The lower graphic bar includes five graphic controls:



- **Back icon** - helps you return one level higher or one step back (depending on the application type).
- **Home icon** - helps you return to the introductory screen.
- **Squares icon** - helps you switch the currently launched applications.
- **Loudspeaker icons** - help you increase/decrease the system loudspeaker volume.

3.3 Launcher Configuration



Click the **Settings** button on the introductory page to access the configuration section. Complete the correct access password.

 **Caution**

- The factory access password is "2n". If you lose the access data, you will have to factory reset the device! Change the password in the Settings - Home screen menu.

The configuration section consists of the following screens and subsections:

- **System info** - display information on the device state.
- **Networks** - configure the device network adapters.
- **Local settings** - set the installation site and input device language.
- **Audio** - set the device audio parameters.
- **Display** - set the device display parameters.
- **Home screen** - modify and set the introductory screen buttons.
- **Software** - set the application installation/uninstallation.
- **Advanced** - restart and LOG.

System Info

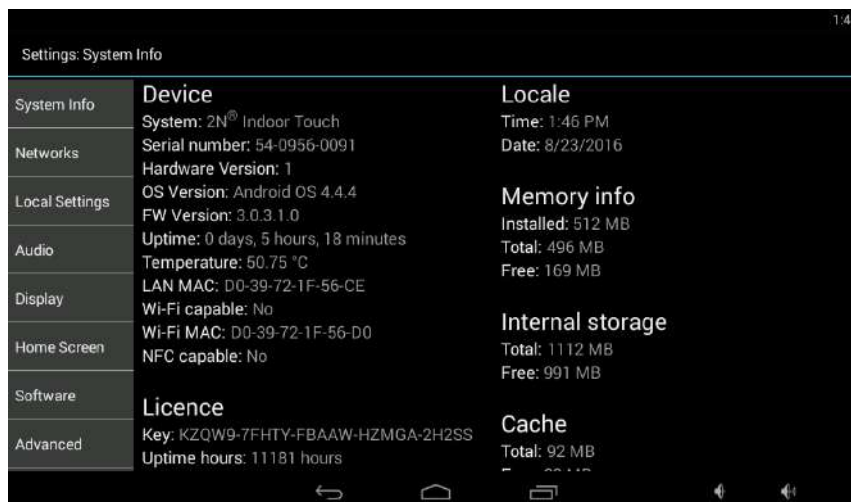

Display the following information on the device:

- **Device** – serial number, configuration and current state.
- **Local** – local date and time.
- **Memory** – current RAM state.
- **Internal storage** – current internal storage state.
- **Licence** – current licence state.
- **Add licence** – licence adding option*.
- **Cache** – current cache state.
- **SD card storage** – external microSD card (SDHC) up to 16GB (if inserted) memory state.
- **LAN, WiFi** – current Ethernet and WiFi adapter configuration.

Licence key types:

- **ICU** – system 2N[®] Indoor Touch licence
- **APP** – third party application download
- **LAUNCHER** – 2N[®] Indoor Touch launcher - Android launcher switching
- **ROOT** – option to use Superuser rights for the applications installed

 **Caution**

- Remember that the original licence key will always be overwritten with the new one! Therefore, add only a valid licence key supplied by your distributor!

 **Warning**

- The **APP** licence unlocks **2N[®] Indoor Touch** for uploading of custom applications from microSD card (SDHC) up to 16 GB. **2N TELECOMMUNICATIONS** does not guarantee functionality and stability of custom applications or **2N[®] Indoor Touch** with its default pre-installed applications after installation of any custom application. If problems are experienced, please remove custom application, and/or do factory reset. Factory reset resets **device** to initial state, without custom applications and settings.
- The **ROOT** licence allows you to start third party applications with the Supersuser rights. Some third party applications, however, may compromise system stability and lead to **device** hardware damage in extreme cases if the Superuser rights are used. Therefore, use the **ROOT** licence at your own risk. Using the **ROOT** licence makes the **device** guarantee null and void.

Networks

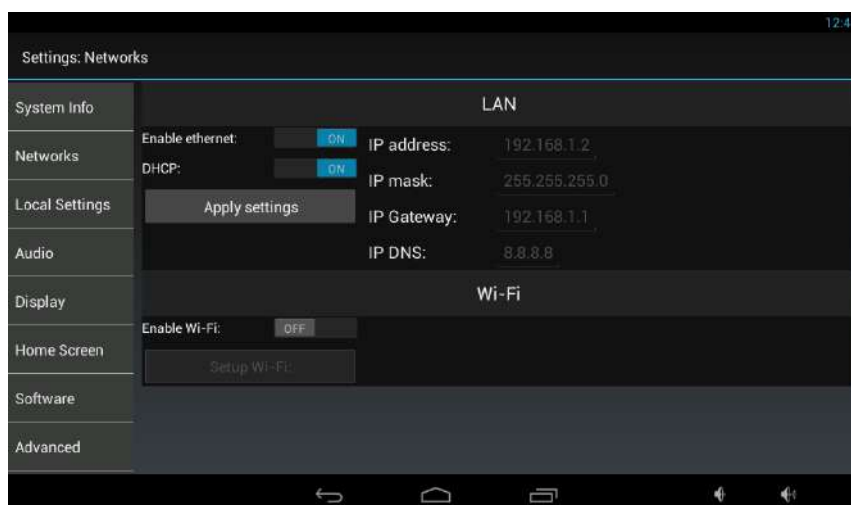

- **LAN** - set the fixed Ethernet interface:
 - **Enable Ethernet** - activate/deactivate the adapter.
 - **DHCP** - enable/disable the DHCP client.
 - **IP address** - IPv4 address if the DHCP client is off.
 - **IP mask** - IPv4 mask if the DHCP client is off.
 - **IP gateway** - gateway IPv4 address if the DHCP client is off.
 - **IP DNS** - DNS server IPv4 address if the DHCP client is off.
- **Wi-Fi** (according to the device type):
 - **Enable Wi-Fi** - activate/deactivate the adapter.
 - **Setup Wi-Fi** - display the Wi-Fi networks in the surroundings, select a network for connection.
 - **DHCP** - enable/disable the DHCP client.
 - **IP address** - IPv4 address if the DHCP client is off.
 - **IP mask** - IPv4 mask if the DHCP client is off.
 - **IP gateway** - gateway IPv4 address if the DHCP client is off.
 - **IP DNS** - DNS server IPv4 address if the DHCP client is off.

Click Apply settings to save the current adapter settings.

Click Select network to select the WiFi AP network to which the device shall be connected.

Caution

- Where WiFi and Ethernet connections are available, we recommend you to choose Ethernet.
- With WiFi connection, please make sure that your **2N[®] Indoor Touch** signal is strong enough and connectivity meets the transmission requirements.
- Make sure that your **2N[®] Indoor Touch** is connected to one and the same LAN with the **2N IP intercom** or the third party unit engaged in the communication.

Refer to <https://faq.2n.cz/> for more details.

Local Settings

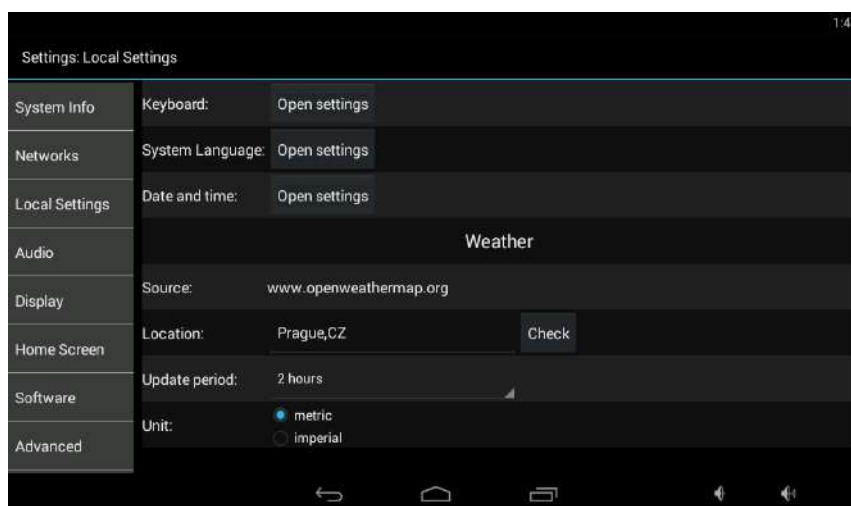

- **Open keyboard settings** – set the system keypad.
- **Open language settings** – set the system language.
- **Launcher language** – set the introductory and setting screen language.
- **Open data and time settings** – set the system date/time.
- **Weather** – set the installation site for weather forecast.

✔ **Tip**

- The weather forecast location includes the local place (town) and country (abbreviated). If you enter an incorrect format, no weather forecast will be displayed. Make sure while setting the location that the device is connected to the Internet. Refer to <http://openweathermap.org/> for more details.



- **2N[®] Indoor Touch** supports launcher and **2N[®] IP Mobile** application translations since firmware version 3.2.x. Changing system language using **System Language** option will cause language change in both launcher and application.
- System language change will cause Home Screen layout change to factory default values! Possible user changes in layout have to be reconfigured.

Audio

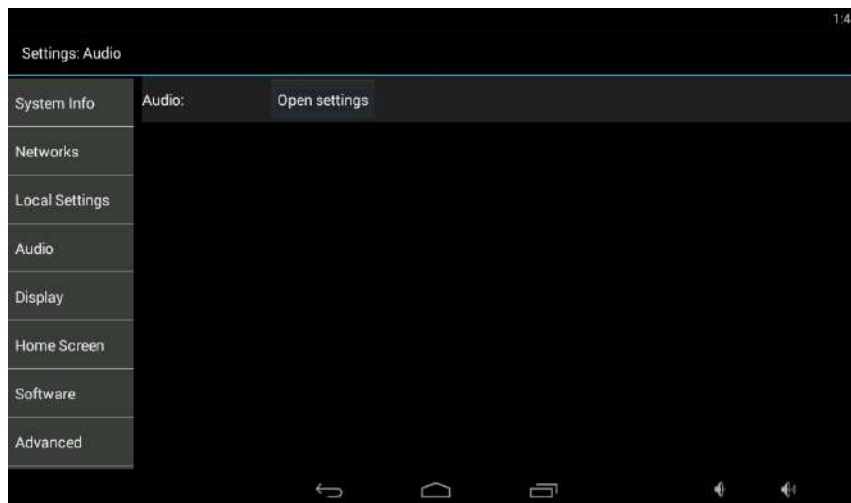

- **Open Settings** – set the device volume level.

Display

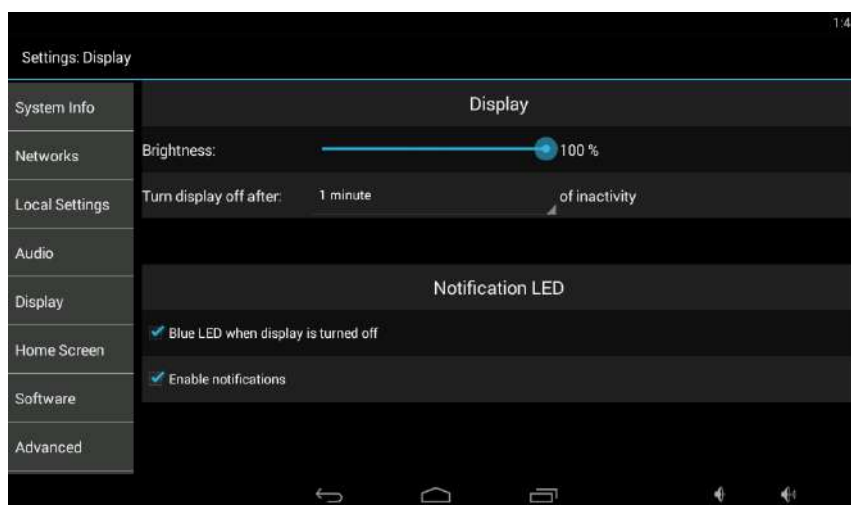

- **Brightness** – set the display brightness level.
- **Turn display off after** – set the timeout for automatic turn-off in case of inactivity.
- **Notification LED**
 - **White LED when display is turned off** – the white LED lights up automatically after the LCD display turn-off to indicate the stand-by mode.
 - **Enable notifications** – enable LED notifications of selected events (missed calls, e.g.) in the stand-by mode.

Home Screen

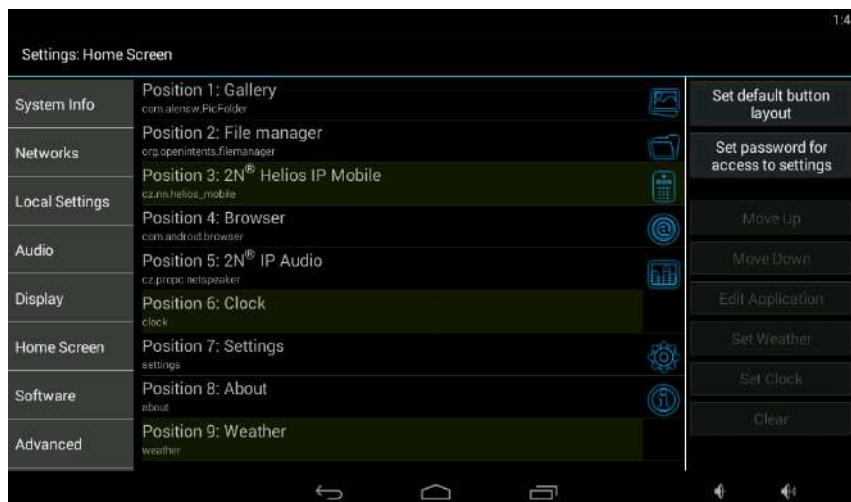

This section helps you change the position and content of the introductory screen tiles and the configuration access password (click Set password for access to settings).

Software

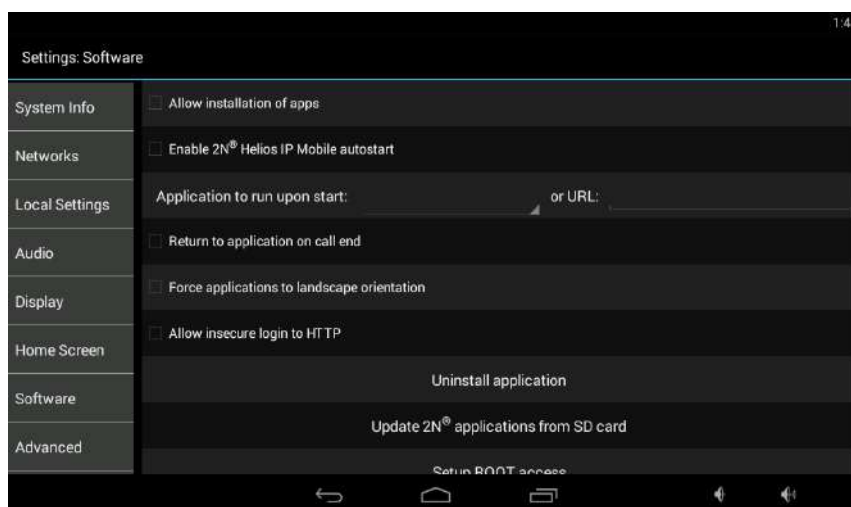

- **Allow installation of apps from unknown sources** – enable/disable installation of other applications from an microSD card (SDHC) up to 16GB or the Internet.

Caution

- The application installation depends on product licensing. You can only install the applications that are equipped with an active APP licence key. Refer to **System info/Licence/Keys** for the current licence state.
- Use **Update 2N[®] applications from SD card** for updating the applications that are already installed.

- **Enable 2N[®] IP Mobile autostart** - enable automatic start of 2N[®] IP Mobile after system startup.
- **Application or URL to run upon start** - run a defined application package upon the 2N[®] IndoorTouch startup (*com.android.browser* for internet browser start, e. g.) or open the URL defined.

Warning

- When you select **URL to run upon start**, enter URL as follows: "http://www.page_for_connection.cz".

- **Return to application on call end** - if an application other than 2N[®] IP Mobile started when the call began, this earlier application will be displayed after the call end.
- **Force applications to landscape orientation** - select this option to force landscape orientation (horizontal viewing) for third parties' applications.
- **Allow insecure login to HTTP** - enable insecure login to HTTP API for 2N[®] IndoorTouch. Use this option for analogue input/output control via HTTP API using the 2N IP Automation functions.
- **Update 2N[®] applications from SD card** - search the microSD card (SDHC) up to 16 GB for applications with signatures matching the applications installed. Then select the required application from a list.
- **Uninstall application** - uninstall the user installed applications.

Caution

- By allowing other application installations you may cause system instability due to an application error! Click Factory reset to delete such applications if necessary!

- **Setup ROOT access** - select the applications to be started with the Superuser rights.

Caution

- The Superuser service depends on product licensing. You can only install the applications that are equipped with an active APP licence key. Refer to **System info/Licence/Keys** for the current licence state.

Warning

- The **ROOT** licence allows you to start third party applications with the Supersuser rights. Some third party applications, however, may compromise system stability and lead to **2N[®] Indoor Touch** hardware damage in extreme cases if the Superuser rights are used. Therefore, use the **ROOT** licence at your own risk. Using the **ROOT** licence makes the **device** guarantee null and void.

Advanced

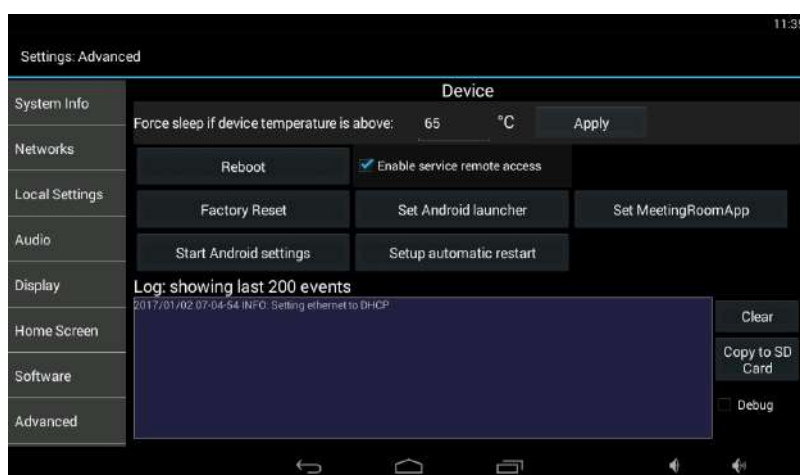

- **Force sleep if device temperature is above** - enable the stand-by mode whenever the device temperature exceeds the defined internal temperature limit.
*
- **Reboot** - restart the device.
- **Factory reset** - reset the device factory values.
- **Enable service remote access** - enables remote Telnet access. This function should be always enabled and its intended for 2N service purposes only.

 **Caution**

- We do not recommend you to change the preset device temperature limit to avoid device life impairment or system instability! In case the device keeps exceeding the temperature limit, please check the installation conditions!

- **Set Android launcher** - delete the 2N[®] Indoor Touch launcher from 2N[®] Indoor Touch to use the Android 4.2.2 launcher. Set the Superuser rights for the selected applications in **Software Setup ROOT access** and then **Set Android launcher**.

 **Caution**

- By enabling the **Set Android launcher** function you delete the 2N[®] Indoor Touch launcher. Press the Factory reset button on the device backside (Subs. 2.1) to reload the 2N[®] Indoor Touch launcher.
- The Android launcher service depends on product licensing. You can only install the applications that are equipped with an active APP licence key. Refer to **System info/Licence/Keys** for the current licence state.

- **Start Android setting** - display the standard Android settings. This section is accessible with a developer's password only. Users do not have access to this section.
- **Setup automatic restart** - display the automatic restart settings. This restart will be repeated at the given time every day.

3.4 Device Upgrade

There are two ways how to upgrade **2N[®] Indoor Touch**: using an SD card (Full Upgrade) or via the device web interface (Partial Upgrade). The firmware package always includes the current Android version, Launcher and **2N[®] IP Mobile** application.

SD card upgrade procedure (Full Upgrade):

1. Download the latest **2N[®] Indoor Touch** Full Upgrade firmware from www.2n.cz.
2. Get a microSD card of the maximum capacity of 16 GB and with the FAT32 file system.
3. Unpack and save the *.ZIP download into the SD card root directory.
4. Insert the SD card in the SD card slot on the left side of **2N[®] Indoor Touch** (refer to **2.1 Before You Start**).
5. Reset the device as follows:
 - a. Press the backside Reset button shortly (refer to **2.1 Before You Start**), or
 - b. Click the Reboot button in the configuration section of the introductory screen (refer to **3.3 Launcher** Configuration).
6. Having detected correct firmware files, **2N[®] Indoor Touch** invites you to confirm upgrade via a touch screen. The upgrade process is also indicated by an RGB LED on the device front (refer to **2.4 Status LED**).
7. Having completed upgrade, remove the SD card and click on the display to restart the system.

 **Warning**

- Full upgrade resets the factory values and deletes all user data including the 2N[®] IP Mobile configuration. To preserve the configuration, save the data on an SD card using the Configuration import/export option in the application settings (refer to **4.1.2.5.1 Settings**) and import the data back to the application after upgrade.

 **Warning**

- Never remove the SD card during upgrade to avoid device damage.
- If you want to interrupt the upgrade process, do it within the first 20 seconds as invited. Upgrade cannot be aborted later. Remember to remove the SD card after upgrade abort to avoid upgrade re-attempt upon the next startup!

Web interface upgrade procedure (Partial Upgrade):

1. Download the latest 2N[®] Indoor Touch Partial Upgrade firmware from www.2n.cz .
2. Expand the package downloaded.
3. Enter the device IP address into the browser address row to enter the **device** web interface.
4. Log in and go to the Maintenance tab.
5. Select Firmware upgrade and load the *.img file included in the firmware package in the wizard.
6. Having completed file loading and verifying, click Upgrade.
7. The device will get restarted and upgrade will be executed automatically.

 **Warning**

- If Factory reset is selected for the device where Partial Upgrade was performed, all data will be deleted and the PRE-upgrade firmware version will be restored!



Caution

- The upgrade process may take up to 10 minutes or more.
- Never disconnect the device from the electric power supply during upgrade to avoid device damage!
- The first system startup after a successful upgrade may take up to a few minutes.

4. 2N® IP Mobile Configuration

This section describes configuration of the pre-installed **2N® IP Mobile** application and the application versions for Android and iOS powered Smartphones and tablets.

Here is what you can find in this section:

- **4.1 2N® IndoorTouch Version**
 - 4.1.1 Application Description
 - 4.1.2 Application Environment and Configuration
 - 4.1.2.1 Devices
 - 4.1.2.2 Call Log
 - 4.1.2.3 Dial Pad
 - 4.1.2.4 My2N Mobile Video
 - 4.1.2.5 User Settings
 - 4.1.2.5.1 Basic Settings
 - 4.1.2.5.2 Do Not Disturb (DND)
 - 4.1.2.5.3 Custom Localization
 - 4.1.2.6 Help
 - 4.1.3 Notifications in 2N® Indoor Touch Environment
- **4.2 Application Use**
 - 4.2.1 LAN Calls
 - 4.2.2 SIP Proxy Server Calls
 - 4.2.3 2N® Mobile Video Calls
- **4.3 Supplementary Information**
 - 4.3.1 Troubleshooting

4.1 2N® IndoorTouch Version

This subsection provides description of the 2N® IP Mobile application for device with firmware 3.0.x and higher.

Here is what you can find in this subsection:

- 4.1.1 Application Description
- 4.1.2 Application Environment and Configuration
 - 4.1.2.1 Devices
 - 4.1.2.2 Call Log
 - 4.1.2.3 Dial Pad
 - 4.1.2.4 My2N Mobile Video
 - 4.1.2.5 User Settings
 - 4.1.2.5.1 Basic Settings
 - 4.1.2.5.2 Do Not Disturb (DND)
 - 4.1.2.5.3 Custom Localization
 - 4.1.2.6 Help
- 4.1.3 Notifications in 2N® Indoor Touch Environment

4.1.1 Application Description

2N[®] IP Mobile is an application designed for making video calls between Android or iOS powered devices and 2N IP intercoms or 2N[®] Indoor Touch communicators. Get the application via the Google Play store.

2N[®] IP Mobile is part of the 2N[®] Indoor Touch firmware.

2N[®] IP Mobile helps you make calls between the 2N[®] Indoor Touch devices.

2N[®] IP Mobile helps you make calls between the Smartphones that are equipped with this application and located in one and the same LAN.

2N[®] IP Mobile helps you make calls between a Smartphone and 2N[®] Indoor Touch device.

2N[®] IP Mobile helps you make calls via the 2N[®] Mobile Video cloud solution.

2N[®] IP Mobile helps you make calls between other SIP supporting devices and applications via the SIP Proxy.

Caution

- Always use the latest 2N IP intercom or 2N[®] Indoor Touch firmware to achieve the optimum application function!

4.1.2 Application Environment and Configuration

Upon the 2N[®] IP Mobile start, the following screen will get displayed (Devices):

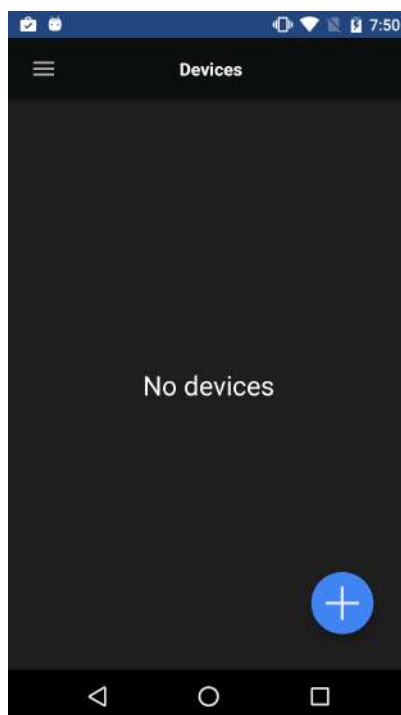

Click the



icon in the left-hand upper corner to expand the main menu.



- The application is automatically set to the Landscape mode in **device**. The main menu is displayed automatically in this mode and the user does not have to click  to expand it.

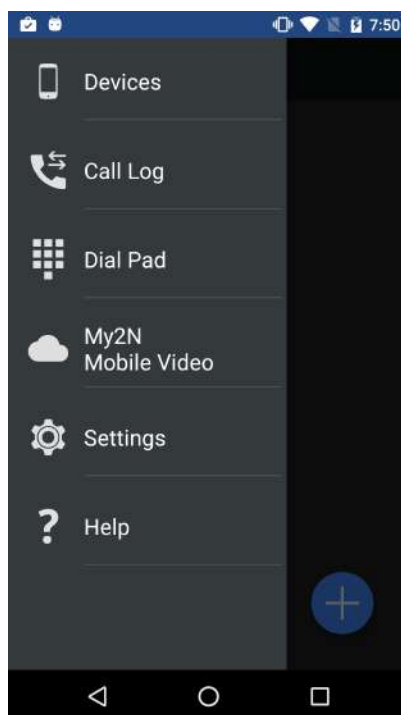

The main menu includes the following items:

- **Devices** – display the list of added devices: 2N IP intercom, 2N[®] IndoorTouch, 2N[®] IP Mobile, 2N[®] Mobile Video or, if SIP Proxy is used, any SIP supporting device.
- **Call Log** – display the list of all incoming/outgoing calls made via the application.
- **Dial Pad** – can be used if the application is registered with the SIP Proxy server or connected to 2N[®] Mobile Video.
- **My2N Mobile Video** – click this option to move the user to the 2N[®] Mobile Video setting section in the Settings menu.
- **Settings** – use this menu to set up the 2N[®] IP Mobile application.
- **Help** – display essential information on the 2N[®] IP Mobile application sections.

 **Tip**

- Click Home on your phone to minimise the application. The application is automatically maximised whenever an incoming call is made. If you are in the Devices menu, you can also click Back to minimise the application.



- The application is set to run on the phone background and wait for incoming calls. To disable the application, you have to open the active application menu and close the application manually (remove **2N[®] IP Mobile** from the list of active applications or go to the system settings, choose the Application administrator, find **2N[®] IP Mobile** and select Force end). You will not be able to receive incoming calls until you re-enable the application.

4.1.2.1 Devices

The Devices section helps you add **2N IP intercom** or **2N[®] Indoor Touch** devices and devices sharing one and the same SIP Proxy server. The **2N IP intercom** and **2N[®] Indoor Touch** devices are retrieved in the LAN automatically by the **2N[®] IP Mobile** application. The devices that are connected to another LAN must use the SIP Proxy server and be added manually to Devices.

You can combine adding of devices from various groups (LAN / Proxy / My2N).

Note



- The application does not allow the SIP Proxy server and **2N[®] Mobile Video** to be connected at the same time. Therefore, switching is made for the devices added too. SIP Proxy account connection, SIP Proxy creation and device listing result in saving of these devices. The application remembers these devices when connected to **2N[®] Mobile Video** and re-lists them in Devices after SIP Proxy re-connection. The added LAN devices are always visible in the Devices menu.

Device Adding

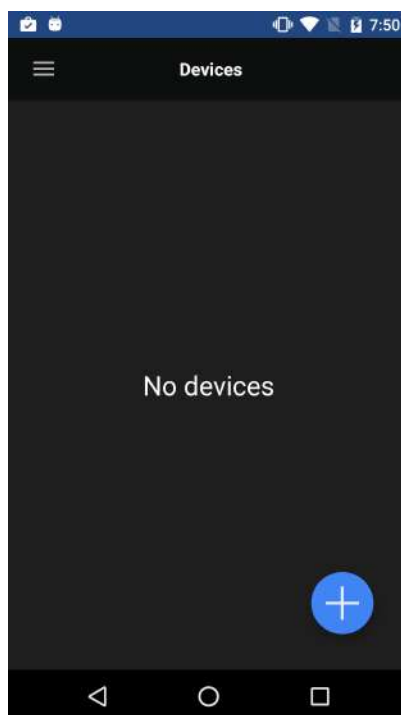
Click the  icon in the right-hand bottom corner of the Devices main window to access the device adding menu.



LAN Devices

The Devices / LAN devices window displays the automatically added **2N IP intercom**, **2N[®] Indoor Touch** and **2N[®] IP Mobile** devices, which are currently located in one and the same LAN. Click the required row to select a device. Each device has a unique name and IP address. The selected device is marked with . Press the  button in the right-hand upper corner to select all the devices listed. Press the  icon to edit the device name.

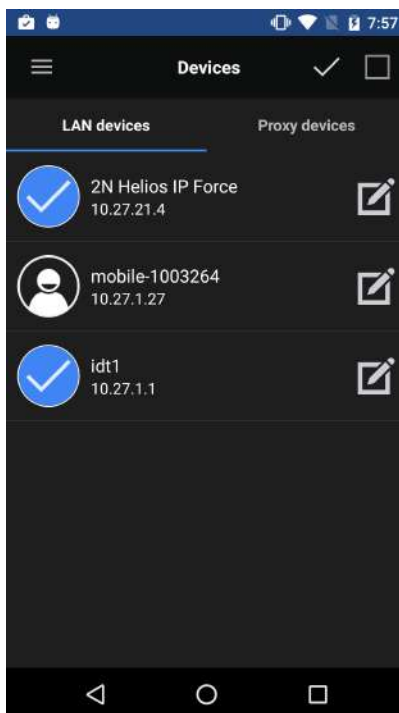

Click the icon in the right part of the application upper panel to save the selected LAN devices. The application will move back to the Devices menu where the selected devices will be displayed.

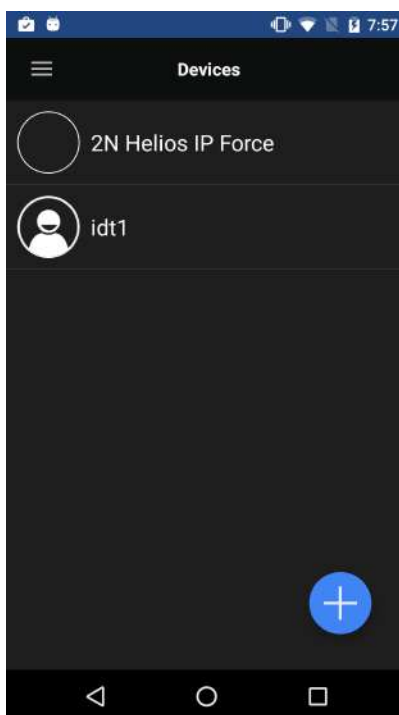

Proxy Devices

It is necessary to register with a SIP Proxy server to enable SIP Proxy devices.

Note

- The application will not allow you to add, create or edit a SIP Proxy device until connected correctly to a SIP Proxy server.

Registration with Proxy

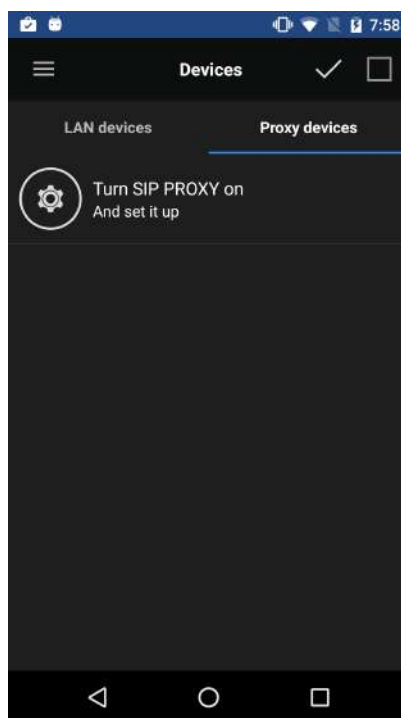

To communicate successfully, 2N[®] IP Mobile and SIP supporting devices have to be registered with a common SIP Proxy server.



Click the  row to switch the application into the Settings menu. Here switch the SIP Proxy ON and then go to the SIP Proxy Settings editing menu to set the SIP Proxy server connecting parameters. Refer to **Subs. 4.3.2.** for details.

Complete the parameters correctly to register 2N[®] IP Mobile with the SIP Proxy server. View the notification icon to check the registration states:

1.  - the application is successfully registered with the SIP Proxy server.

2.  - the application is trying to register with the SIP Proxy server. The SIP Proxy registration has not been successfully completed yet.
3.  - the SIP Proxy server registration is inactive due to SIP Proxy server rejection or unavailability.

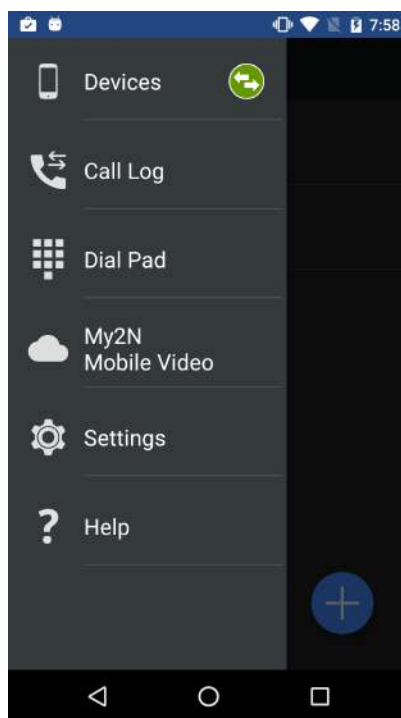

 **Caution**

- The 2N[®] IP Mobile application requires the minimum registration expiration time of 60 s to avoid disconnection from the SIP Proxy server.

Proxy Device Adding

If 2N[®] Indoor Touch with 2N[®] IP Mobile is successfully registered with a SIP Proxy server, SIP Proxy devices can be added to the Devices list manually. Click the  icon in the right-hand bottom corner of the Devices main window to enter the editing menu. Then switch the editing menu to the Proxy devices section using the tab below the application title row.

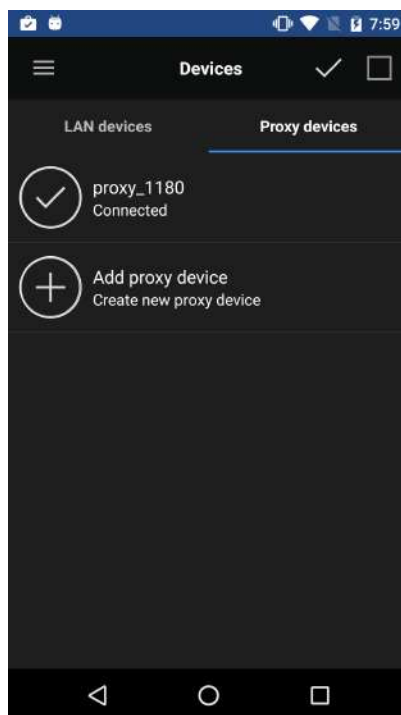



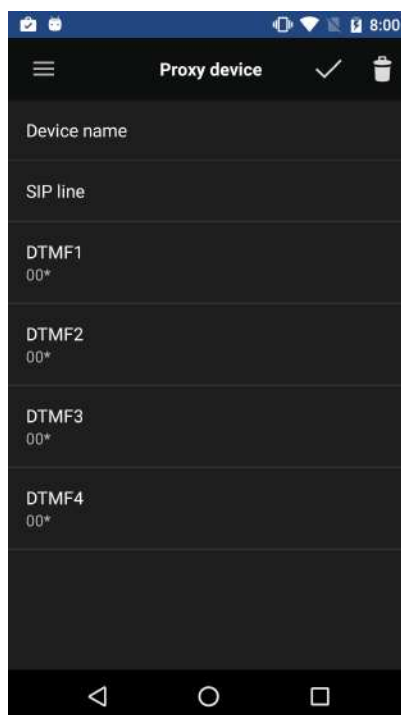

Select a row with the  Add proxy device button to add a SIP Proxy device.

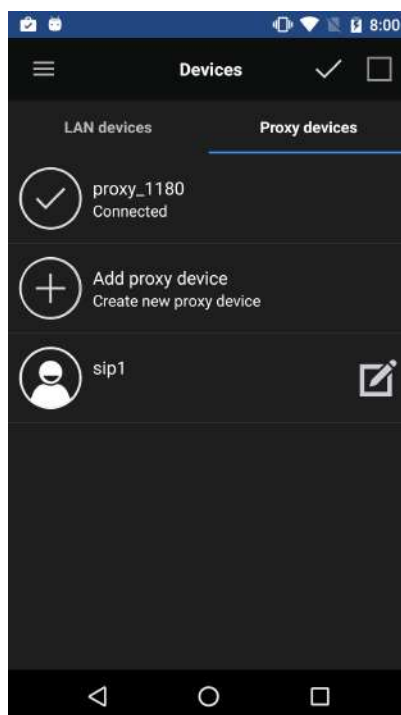

Complete the following parameters:

- **Device name** - device name under which the device will be presented in **2N[®] IP Mobile**. For application use only.
- **SIP line** - line to be dialled by **2N[®] IP Mobile** for outgoing calls.
- **DTMF1-4** - DTMF to be sent when lock 1-4 is pressed. These parameters are primarily used for sending DTMF codes to an **2N IP intercom** and subsequent unlocking of the lock connected.



The selected device is marked with . Press the  button in the right-hand upper corner to select all the devices listed. Press the Edit  icon to edit the device name. Click the Save  icon to save the selected Proxy devices. The application will move back to the Devices menu where the selected devices will be displayed.

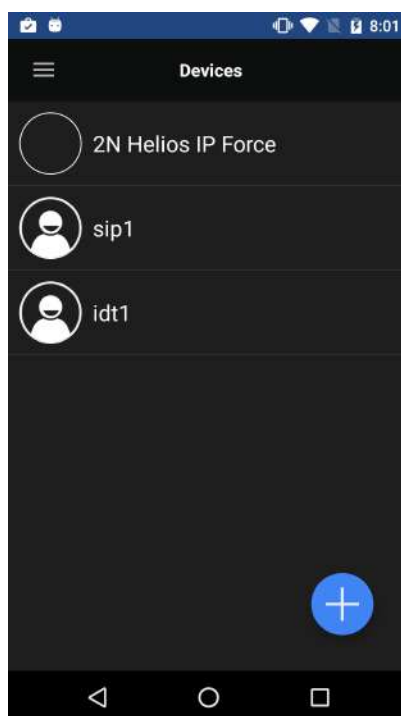

My2N Devices

My2N devices are devices from the **2N[®] Mobile Video** service. Like SIP Proxy devices, My2N devices cannot be added to Devices until the application is connected to the cloud at www.my2n.com.

Note

- To use the **2N[®] Mobile Video** functions, create an account on the service web and 1 device at least of the Smartphone or Tablet type. Refer to **faq.2n.cz** for setting details.

Warning

- When the 30-day Trial licence expires, you have to purchase a licence for your devices to make use of the **2N[®] Mobile Video** functions. Otherwise, you will not be able to log in and use the cloud call functions.

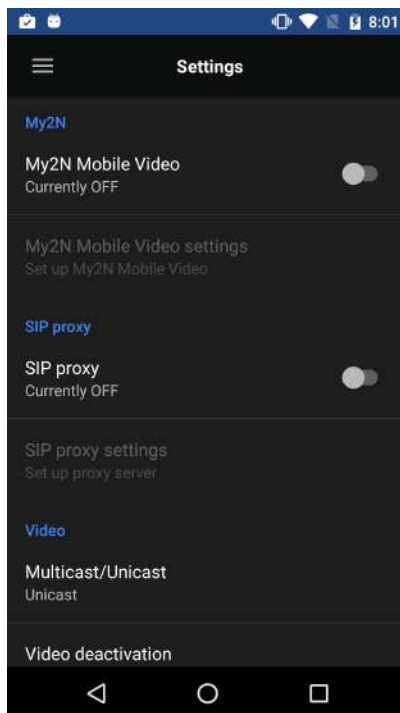

Connection to Service

Use the application settings to get connected to the **2N[®] Mobile Video** service. Get there via the main menu Settings by clicking the My2N Mobile Video anchor, which moves you directly to the My2N settings. Turn the switch to ON to activate the My2N Mobile Video settings and complete login data. Refer to Subs. **4.3.3** for details.



The Phonebook (device list) defined for this device on the service web is downloaded to your phone during login and displayed in My2N devices, which replaces the Proxy devices tab. The Phonebook is also automatically added to Devices.

The application indicates the **2N[®] Mobile Video** server connection states. The icon is next to the My2N Mobile Video tab and indicates the following states:



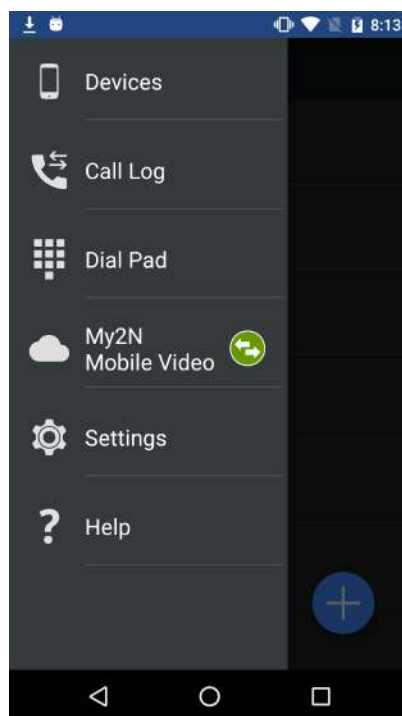

1.  - the application has downloaded all data successfully and is registered with the **2N[®] Mobile Video** SIP Proxy server.
2.  - the application has downloaded all data successfully and is trying to register with the **2N[®] Mobile Video** SIP Proxy server. The connection has not been successful yet.
3.  - the application cannot get connected to the **2N[®] Mobile Video** servers.

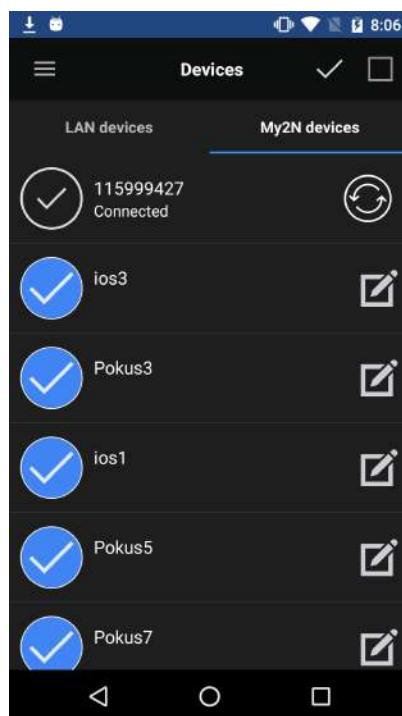

My2N Device Adding

The downloaded Phonebook is displayed in the Devices menu when 2N[®] IP Mobile gets connected to and registered with 2N[®] Mobile Video successfully. You can edit the Phonebook device list: disable displaying of or change the device name. Again, click the  icon located in the right-hand bottom corner of the Devices main window to enter the device adding menu. Then switch the window to the My2N devices menu using the tab below the application title row.





The selected device is marked with . Click the  button located to the right on the upper application bar to select all the devices listed. Click the  icon to display the editing menus of all the devices. Click the  icon to save the selected My2N devices. The application will then move to the Devices menu where the selected devices will be displayed. Press  to re-download the Phonebook without re-logging in from the application.

 **Note**



- When the Phonebook is downloaded, all the devices associated with 2N[®] **Mobile Video** are selected and added to Devices.
- You can only change the name of a device displayed in the application while editing the My2N devices. Thus, a name change will not result in a name change on the service web.

4.1.2.2 Call Log

The 2N[®] IP Mobile Call Log section displays the outgoing/incoming call logs. The following values are available:

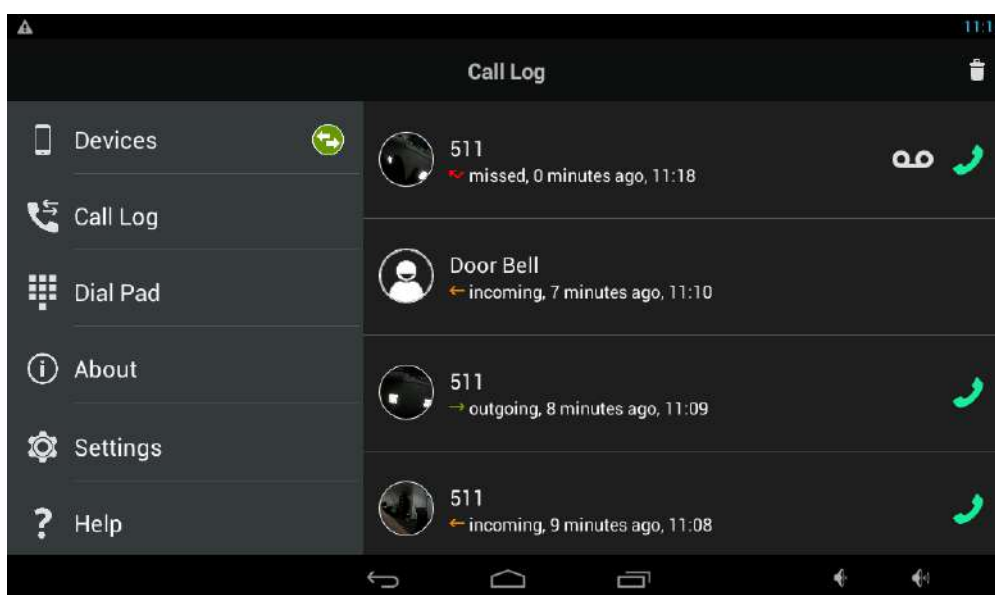
-  outgoing – outgoing call
-  incoming – incoming call
-  missed – missed call



The call log icon contains either a snapshot from the device or an avatar. The avatar is displayed whenever the snapshot parameter is inactive, the device is not equipped with a camera or no snapshot was created due to a short video display. Moreover, you can use the Callback function via . If the recorder is active and an incoming call has been recorded, press  to play the record. Use the trash icon to the right to delete the records.

Caution

- A snapshot is created when the active video stream view takes about 3-5 s.
- The maximum Call Log count is 30.
- When the Call Log is full, the oldest records are automatically deleted and replaced with newer records.

Select a record to be displayed. The records include call duration and a magnified snapshot. If a record from the recorder is included, find the missed call and play it. The application also enables you to export a record to your phone storage: click the  icon in the right-hand upper corner of the application.

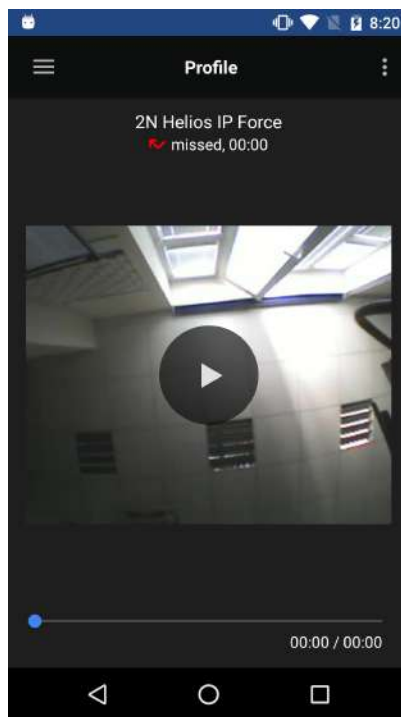

 **Caution**

- The duration of unanswered outgoing/incoming calls is 0:00.



- Refer to faq.2n.cz for details on the recorder use .

4.1.2.3 Dial Pad

The Dial Pad menu helps you call SIP devices via the SIP Proxy server if you know the called line number. When **2N[®] IP Mobile** is not registered with a SIP Proxy or **2N[®] Mobile Video** server, the Dial Pad function is inactive.

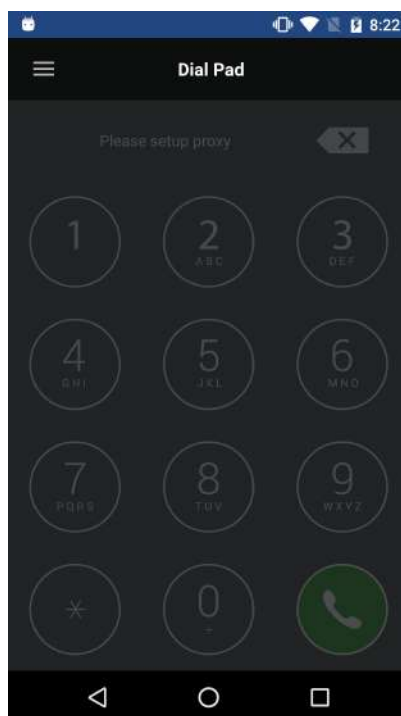

When the **2N[®] IP Mobile** application gets registered with a SIP Proxy or **2N[®] Mobile Video** server, the Dial Pad will become active.



An avatar is displayed during Dial Pad call ringing in case the called device does not support video stream transmission. If the called device supports video transmission, the video stream is displayed like a call from a device added to Devices.

 **Caution**

- Dial Pad disables sending tone signalling (DTMF) during calls.
- You can make calls to a My2N device via the Dial Pad too: connect to **2N**[®] **Mobile Video** and dial the Device ID.

4.1.2.4 My2N Mobile Video

Click My2N Mobile Video in the main menu to move to the 2N[®] Mobile Video connection settings in the application. The following screen will be displayed:

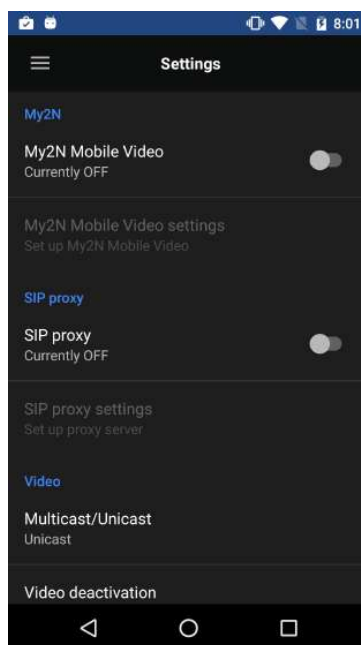

Connection to Service

First turn the switch from OFF to ON to activate the My2N Mobile Video settings. Click the settings to display a window with more settings.

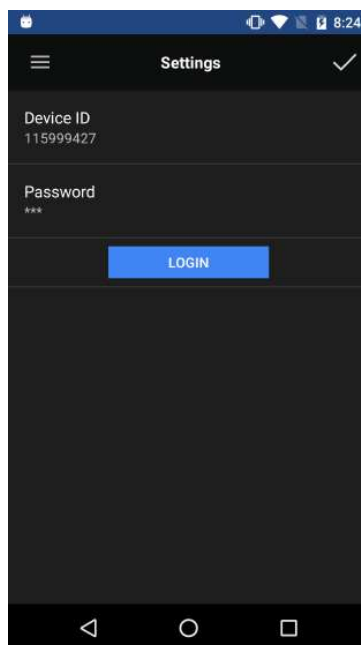

This window includes the following items:

- **Device ID** - device ID that is generated on the service web after device creation.
- **Password** - password generated by the system after device creation.
- **Login/Logout** - service login/logout button.

Complete the above mentioned items and click Log in to initiate login and connection. The login process has 3 phases:

1. Configuration download - data necessary for the next phases are downloaded.
2. Phonebook download - Phonebook (device list) is downloaded that is assigned to the device on the service web.
3. SIP Proxy login and registration - service SIP Proxy server login and registration.

When phase 3 is completed, be sure to click OK. Click to move the application to Devices upon login.

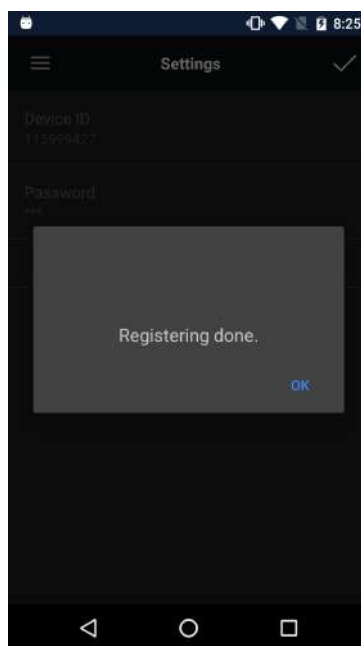

 **Note**

- Refer to faq.2n.cz or www.my2n.com for more information on 2N[®] Mobile Video.

4.1.2.5 User Settings

This section describes the basic and extending setting of the the 2N[®] Indoor Touch product.

Here is what you can find in this section:

4.1.2.5.1 Basic Settings

4.1.2.5.2 Do Not Disturb (DND)

4.1.2.5.3 Custom Localization

4.1.2.5.1 Basic Settings

The Basic settings section helps you set the **2N[®] IP Mobile** parameters. The following parameters are available:

- **Device name** - set the device name under which **2N[®] IP Mobile** identifies itself to other devices in the LAN.
- **Autosnapshot** - activate/deactivate Autosnapshot, which helps acquire an image from the video view. The image replaces the circled avatar symbol at the devices added to Devices and Call Log.
- **Push to talk** - set communication via half-duplex connections, where only one-directional communication is possible: ON/OFF, the default value is ON.
- **Call pick up**
 - **Automatic call pickup** - set the automatic incoming call pickup.
 - **Automatic call pickup delay** - set the delay before the automatic incoming call pickup.
- **Settings password** - you need to know the password if defined to get access to Settings and Add Devices.
- **Access key** - **2N[®] IP** intercom group authenticating password. If the password is set, the scanner in Devices / Add Devices / Local devices only searches for **2N IP** intercoms, **2N[®] Indoor Touch** and applications with the same password.

Tip

- Refer to faq.2n.cz for details on the **Access Key** function.

- **Volume level** - set the volume level during a call.
- **Mic sensitivity** - set the microphone sensitivity during a call.

Caution

- The **Volume level** and **Mic sensitivity** only adjust volume during calls. The ringing volume is controlled by the Launcher system settings and not by the application.

- **Ringtone** - select the **2N[®] IP Mobile** ringing tone.
- **Custom ringtone file** - record an audio file to be used for the ringing tone. The supported format is .wav, 15 MB, shortened to 15 s, PCM8/PCM16.
- **My2N**
 - **My2N Mobile Video** - activate/deactivate the **2N[®] Mobile Video** service.
 - **My2N Mobile Video settings** - set the **2N[®] Mobile Video** parameters.
 - **Device ID** - device ID assigned by **2N[®] Mobile Video**.
 - **Device Password** - automatically generated device password for connection to **2N[®] Mobile Video**.
- **SIP Proxy**
 - **SIP Proxy** - activate/deactivate the SIP Proxy service.
 - **SIP Proxy settings** - set the SIP Proxy parameters.
 - **Display name** - account name to be displayed in the application.
 - **Username** - username at the SIP Proxy server.
 - **Password** - user password at the SIP Proxy server.
 - **SIP Proxy** - IP address or domain name of the SIP Proxy server.
 - **Port** - SIP Proxy server connection port (default port: 5060).
 - **Transport** - choose a transport protocol: TCP or UDP.
- **SIP ports randomisation**
 - **SIP ports randomisation** - set a randomly generated port. Re-registration to the SIP Proxy or My2N follows any configuration change.
 - **SIP port** - set a selected SIP port manually if SIP port randomisation is enabled.

 **Tip**

- Refer to faq.2n.cz for SIP Proxy call settings.

- Video

- **Multicast/Unicast** - select the **2N IP intercom** video stream transmission type.
- **Video deactivation** - set the period of time during which a view of the video stream from a **2N IP** intercom device listed in Devices is displayed.
- **Earlymedia** - activate/deactivate video stream transmission during incoming call ringing from devices registered with the SIP Proxy.

 **Tip**

- Refer to faq.2n.cz for Multicast/Unicast details.

 **Caution**

- Earlymedia is always enabled for 2N[®] Mobile Video.

 **Warning**

- Refer to faq.2n.cz for details on the LAN / Wi-Fi where the application is used.

- **Recorder**
 - **Recorder ON/OFF** - activate/deactivate the recorder function.
 - **Recorder activation timeout (s)** - set the incoming call timeout after which the recorder is activated.
 - **Record announcement** - select the announcement type to be played:
 - **Default tone** - default announcement that is part of the 2N[®] IP Mobile application.
 - **Tone from file** - tone selected from a file.
 - **Recorded tone** - announcement recorded in the Record custom announcement section of 2N[®] IP Mobile.
 - **File** - display the folder structure of files.
 - **Record custom announcement** - record a recorder announcement of your own. The supported format is .wav, 15 MB, shortened to 15 s, PCM8/PCM16.
 - **Play actual announcement** - play the currently set and active announcement.

 **Caution**

- If **Recorder** is enabled, the call is answered and recorded **by 1 device only**. If **Recorder** is activated on multiple devices in one LAN or one called group, the call is answered by and recorded by the device that was the first to receive the call (on condition that an identical **Recorder activation timeout** is set for all the devices) or whose **Recorder activation timeout** is the shortest. If there is a heavy LAN traffic and call setups may be delayed, it cannot be guaranteed that a call will be answered and recorded by one and the same device.

- **Door button**
 - **Door button** - activate/deactivate the door button function.
 - **Used input** - ON/OFF. The default value is ON. Define the pulse rising /falling edge detection and the application response. In the ON state, the application starts ringing when the falling edge is detected, i.e. when the button is released. OFF starts ringing when the rising edge is detected, i.e. when the button is pressed.
 - **Used input** - display the input to which the door button is connected.
 - **Minimal ringing time** - set the minimum ringing time upon the button press.
 - **Maximal ringing time** - set the maximum ringing time upon the button press.
 - **Door ringtone** - choose the default user ringtone.
 - **Bypass DND mode** - select ON to set ringing via DND.

- **External ringing notification**
 - **External ringing notification** - set relay activation at an incoming call. The default value is OFF.
 - **Used input** - ON/OFF. The default value is ON. Define the pulse rising /falling edge detection and the application response. In the ON state, the application starts ringing when the falling edge is detected, i.e. when the button is released. OFF starts ringing when the rising edge is detected, i.e. when the button is pressed.
 - **Used input** - display the input to which the door button is connected.
 - **Minimal ringing time** - set the minimum ringing time during which the relay is closed.
 - **Maximal ringing time** - set the maximum ringing time during which the relay is closed.
 - **Bypass DND mode** - select ON to set ringing via DND.

- **Configuration Import/Export**
 - **Import configuration** - import the 2N[®] IP Mobile settings from a configuration file except for the devices added to Devices.
 - **Export configuration** - export the 2N[®] IP Mobile settings into a configuration file in the system or on an SD card.

 **Warning**

- Unicast video transmission is only suitable for installations with up to 3 devices with **2N[®] IP Mobile**. A higher count of devices in the network may cause video and call transmission problems. Therefore, you are advised to use Multicast video transmission with the Multicast supporting network elements for more extensive installations.
- If **2N[®] IP** intercom **Group Authentication** is enabled, all local devices will be removed from Devices due to an invalid password. The devices with a password identical with that in **2N[®] IP** intercom **Group Authentication** will only be detected in the LAN.

- **Logging** - enable/disable the application logging into the system log.
- **Multicast** - enable/disable sending multicast packets to the LAN. These packets are used for communication between 2N products within the LAN.

 **Warning**

- The **logging** option should be disabled all the time unless there is an issue with **2N[®] IP Mobile**.
- Another **2N[®] IP Mobile** within the LAN CANNOT see the application with the **Multicast Discovery** option disabled.

- **Multicast Discovery** - ON/OFF; ON is the default value. When ON, **2N[®] Indoor Touch** sends info packets to the multicast network. When OFF, **2N[®] Indoor Touch** sends info packets in unicast always to the IP address of the 2N IP intercom observed and periodically to all the **2N IP intercoms** in the LAN device list. In the unicast mode, info packets are only sent to the 2N IP intercoms; no other **2N[®] Indoor Touch** devices in the LAN are sent any info packets.

4.1.2.5.2 Do Not Disturb (DND)

Configure the Do Not Disturb function to prevent 2N[®] IP Mobile from ringing within a selected time interval. Any incoming call made within the active time interval is only displayed via 2N[®] IP Mobile (no ringing). The call can be processed in a usual manner.

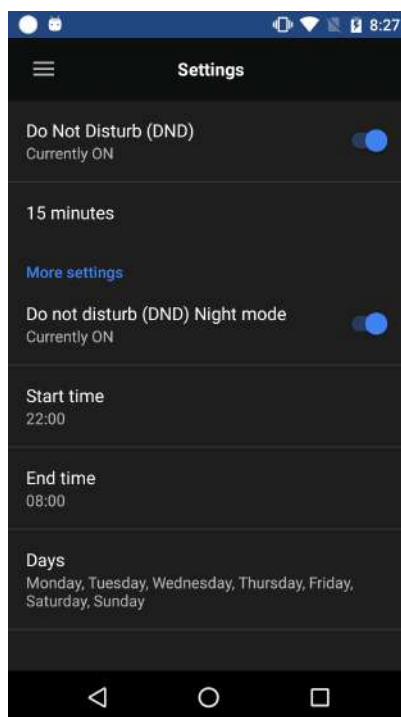

The  notification icon indicates the Do Not Disturb function activation.

Do Not Disturb (DND) – set an unrepeatable time interval to 15 minutes – 24 hours. When this time expires, the DND function will become inactive.

Do Not Disturb (DND) Night mode – set an unrepeatable time interval to Start time – Stop time.

- **Start time** – Do Not Disturb activation time.
- **Stop time** – Do Not Disturb deactivation time.
- **Days** – Do Not Disturb is only activated at Start time on active days and deactivated at Stop time. The Stop time parameter may overlap to inactive days.

Tip

- Refer to faq.2n.cz for DND details.

4.1.2.5.3 Custom Localization

The custom language settings help you use the translations in the application that are not part of the application packet. Use JSON strings for language settings.

The user translation texts are optionally saved in the translationMap.json file in an external storage (physical or emulated SD card) with the following path:

/sdcard/hipmo-localization/translationMap.json.

The hipmo-localization folder is automatically created on the first available SD card upon the application start. If there are multiple SD cards in the device or you do not know which to use, you can verify upon start on which SD card the folder was created.

Caution

Make sure that the file name format is **translationMap.json**, i.e. do not add any (language) extensions or insertions. For example, translationMap-cs.json is incorrect.

Text file structure

JSON with user text translations contains root element data, which is the field of translation elements:

```
{ "data": [
```

```
  translation,
```

```
  translation,
```

```
  ...
```

```
  translation
```

```
]}]
```

Each *translation* element has the following structure:

```
{"key":{"hint":"hint_string","value":"translated_string"}}
```

where

- **key** – is the text string key (substitutes name in strings.xml)
- **hint_string** – is the meaning of the text
- **translated_string** – is the user text translation

Example:

```
{"title_call_declined":{"hint":"Call declined","value":"Call declined"}}
```

We recommend you to edit just translated_string; hint_string can be edited only if useful.

 **Warning**

You are not recommended to edit **KEY** to avoid unpredictable behaviour of the application.

The application checks whether there is a file in the asset that matches the current Locale setting in the device. If so, the application adds the set keys to the map. If the keys are identical, the old values are replaced with new ones.

The application verifies the Custom Localization switch state in the configuration. If the function is enabled and there exists an appropriate user translation file in the device, the application adds the set keys to the map as mentioned above.

 **Caution**

Untranslated strings are displayed in the English language.

4.1.2.6 Help

Click Help to display basic information on selected elements of the 2N[®] IP Mobile application.

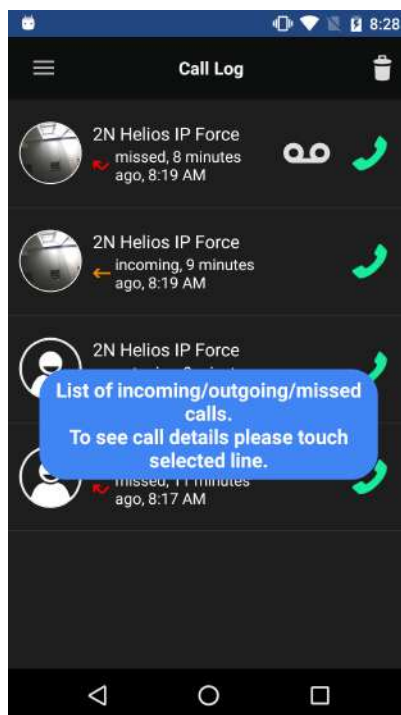

4.1.3 Notifications in 2N® Indoor Touch Environment

The 2N® IP Mobile application uses LED notifications. The 2N® Indoor Touch LED starts flashing red in case:

- There is an unread missed incoming call in the application, or
- 2N® Indoor Touch is in the stand-by mode.

4.2 Application Use

This subsection provides basic instructions on how to put the application in operation for typical use.

- 4.2.1 LAN Calls
- 4.2.2 SIP Proxy Server Calls
- 4.2.3 2N® Mobile Video Calls

4.2.1 LAN Calls



To communicate with an **2N IP intercom**, it is necessary to change a setting in the door communicator to be connected. Refer to the online **Configuration manual for 2N IP intercoms** or **FAQ**:

- **2N[®] IP Mobile v4** - How to set communication between Indoor Touch/IP Mobile and 2N[®] IP intercom?



4.2.2 SIP Proxy Server Calls

To make calls via a SIP Proxy server set the application server connection correctly in the SIP Proxy section of the Settings menu. Get the login data from the SIP Proxy server provider.

Once connected, you can dial other devices directly from the application Dial Pad or create a SIP Proxy device, click it to display the device card and start calling. Click  to start calling. Click the  icon to send the set DTMF code to the device.

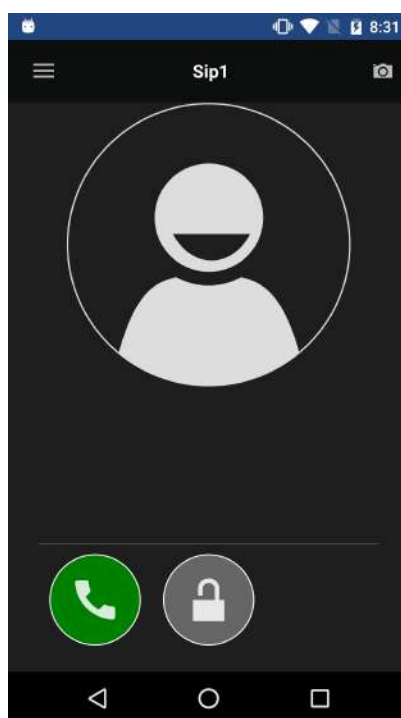

- Press and hold the lock button to display the lock list (locks 1-4) to control all the locks (not only the default one).

 **Caution**

- It is impossible to send the DTMF code from the application outside a call for technical reasons. Therefore, if you press the lock outside a call in the SIP Proxy mode, a call is set up first during which the DTMF is sent automatically.
- If the **2N IP intercom** and the application are in one and the same LAN, the incoming call is always identified as a LAN call even if it goes via a SIP Proxy server. If you require SIP Proxy identification and the application and **2N IP intercom** share one and the same LAN, set a different **2N[®] IP Group Authentication** password in the application.

 **Warning**

- Remember that calls from a phone that uses data connection instead Wi-Fi consume data from your mobile provider's data package!



- Refer to faq.2n.cz for more details on SIP Proxy server calls.

4.2.3 2N® Mobile Video Calls

It is very easy to set the application for calling via 2N® Mobile Video. All you have to do is set correct login data in the application settings:

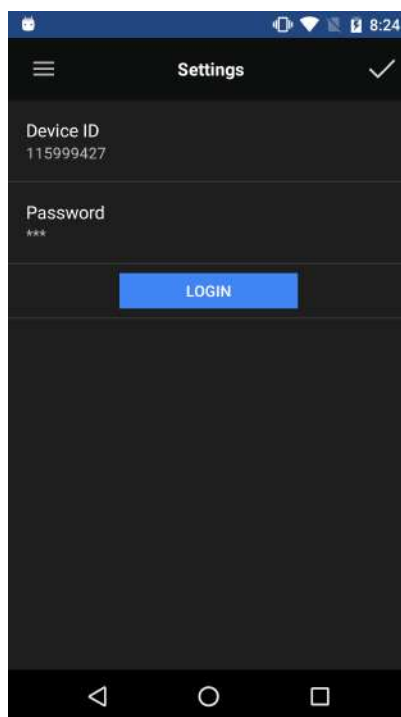

Having completed the login data, press the Log in button for the application to log in and download contacts. Then select a device from the list and make a call.

Refer to faq.2n.cz for how to get login data for the 2N® Mobile Video servers.



- Press and hold the lock button to display the lock list (locks 1–4) to control all the locks (not only the default one).
- Click the name of the **2N IP intercom** added using Phonebook via My2N to set up a call with the device immediately. During the call, the microphone on the application side is muted so that the visitor cannot hear you. This mode is suitable for remote silent monitoring of the space in front of the door. This mode is only available to the **2N IP intercoms**.

Standard calls can only be made to other applications or the **2N[®] IndoorTouch** devices.



Caution

- It is impossible to send the DTMF code from the application outside a call for technical reasons. Therefore, if you press the lock outside a call in the SIP Proxy mode, a call is set up first during which the DTMF is sent automatically.
- If the **2N IP intercom** and the application are in one and the same LAN, the incoming call is always identified as a LAN call even if it goes via a SIP Proxy server. If you require SIP Proxy identification and the application and **2N IP intercom** share one and the same LAN, set a different **2N[®] IP Group Authentication** password in the application.
- Earlymedia is always enabled for the My2N mode. This means that the calling door unit video is displayed by the application during ringing.



Warning

- Remember that calls from a phone that uses data connection instead Wi-Fi consume data from your mobile provider's data package!

4.3 Supplementary Information

This subsection provides supplementary information on the 2N[®] IP Mobile product.

Here is what you can find in this subsection:

- 4.3.1 Troubleshooting

4.3.1 Troubleshooting

Question: The application cannot see any devices in the LAN mode.

- **Answer:** Make sure that you are really connected to the LAN where the other devices are installed. If you are, then check the settings of the other devices, particularly the **2N IP Group Authentication** password. Make sure that the password matches the passwords of all the devices to be listed in the application.

Question: The application sees a 2N IP intercom in the LAN but cannot call it.

- **Answer:** Check whether automatic rejection of incoming calls is enabled in **2N IP intercom**. Find this setting on the device web interface in the Services / Telephone / Calls section. Make sure that automatic receiving of calls on SIP1 line is enabled.

Question: The application video quality is low or video playing is jerky.

- **Answer:** If you are not satisfied with the video quality, set a higher video transmission rate and resolution for your **2N IP intercom**. If your video transmission is jerky or yielding artifacts, your LAN is probably overloaded. Try to earmark a larger bandwidth for VoIP communication on your router or acquire a router that supports the latest Wi-Fi standards (802.11n / 802.11ac). The function may not be ideal with 802.11g.

If your questions still remain unanswered, use the following link please:



Nejčastěji řešené problémy najdete na stránkách faq.2n.cz.

If you are 2N's registered partner or distributor, you can use the Technical Support portal at support.2n.cz.

5. Web Interface Configuration

2N[®] Indoor Touch allows the user to configure a majority of launcher and 2N[®] IP Mobile parameters via the web interface.

Here is what you can find in this section:

- 5.1 Login
- 5.2 System Info
- 5.3 Device
- 5.4 Application
- 5.5 Limitations

5.1 Login

Enter the **2N[®] Indoor Touch** IP address into the web browser address row to connect to the web interface. The currently supported browsers are Internet Explorer, Google Chrome, Firefox and Opera.

Then enter the user name and password to access the configuration section. The default values are as follows:

- **User Name:** Admin
- **Password:** 2n (or a valid configuration password in **2N[®] Indoor Touch**)



- If **2N[®] Indoor Touch** is allowed to access configuration without a password, then the web interface password is identical with the last-used password and can be changed.

5.2 System Info

This subsection includes relevant system information.

Contents:

- 5.2.1 Status
- 5.2.2 Logs

5.2.1 Status

Device status screen:

- **Licence** - licence state
 - **State** - Limited/Unlimited
 - **Remaining** - remaining time for a time-limited licence; unlimited licence reports No Limit
 - **Licensed Features** - refer to the licence key types below
 - **Licence Key** - currently used licence key
 - **Upload Licence** - display a licence key adding dialogue
- **Device** - current information on the device
 - **System** - device name
 - **Serial Number** - device serial number
 - **Total Uptime** - total operation time since the first start
 - **Uptime from restart** - time since the last restart
 - **OS Version** - operating system version and type
 - **Firmware Version** - firmware version
 - **Hardware Version** - hardware version
 - **Wi-Fi Capable** - WiFi module availability info
 - **NFC Capable** - NFC reader availability info
 - **Wi-Fi MAC** - WiFi module MAC address
 - **LAN MAC** - Ethernet module MAC address
 - **Temperature** - current device temperature
- **Time** - current data and time
- **Memory** - RAM current state
 - **RAM** - information on installed, available and used RAM
 - **Internal Storage** - information on total and free internal memory capacity
 - **Cache** - information on total and free cache memory capacity

Licence key types:

- **APP** - third party application download
- **LAUNCHER** - 2N[®] **Indoor Touch launcher** - Android launcher switching
- **ROOT** - option to use Superuser rights on installed applications
- **HTTPAPI** - 2N[®] **Indoor Touch** control via API



Caution

- The original licence key will be overwritten! Be sure to enter the valid licence key obtained from your supplier!

 **Warning**

- The **APP** licence unlocks **2N[®] Indoor Touch** for recording of user applications from a microSD (SDHC) card (up to 16 GB). **2N TELEKOMUNIKACE a.s.** does not guarantee functionality and stability of user applications or correct function of pre-installed applications in **device** after user applications are installed. Should there be problems, remove your own applications or reset the device to factory values. Factory reset restores the original state of **device**, i.e. the state without user applications and settings.
- The **ROOT** licence helps you run third party applications with Superuser rights. Some third party applications with Superuser rights, however, may cause system instability and, in extreme cases, damage the device hardware. Therefore, using the **ROOT** licence is always at the user's own risk and leads to a loss of **2N[®] IndoorTouch** warranty.

5.2.2 Logs

This subsection helps you browse through the **2N[®] Indoor Touch** logs and debug logs.

- **Activate debug logs** - switch basic information logs to advanced debug logs.

Up to 200 logs can be displayed starting from the latest one.

Log types:

- SEVERE (most serious)
- WARNING
- INFO
- CONFIG
- FINE
- FINER
- FINEST (least serious)

The **debug** mode displays all the log types. The basic mode only displays the INFO and WARNING logs.

Details on log types:

- **SEVERE** - this log indicates a severe failure. In general, this log type is displayed in case the launch of a program part fails. It should be sufficiently clear to both the end user and system administrator.
- **WARNING** - this log indicates a potential problem. It describes events that the user or administrator should take care of to avoid failure.
- **INFO** - this log informs of the states of all system parts. As a rule, these logs do not announce a problem or failure but notify the user/administrator of what is going on in the system.
- **CONFIG** - this log announces system configuration changes. It should provide enough information on hardware configuration and settings. Typically, it includes CPU, GPU, GUI and similar information. Some announcements can be found in the INFO logs too.
- **FINE** - this log provides essential information on system operation. These logs include general information that is relevant for the administrators who are not concerned with specific subsystems. Typically, these logs include minor failures that do not affect the system function and potential risks associated with the hardware performance.

- **FINER** - this log provides system operation details. It is more detailed than a FINE log and includes mostly function inputs and returns in the system or exceptions.
- **FINEST** - this log provides the finest system operation details. It includes more information than FINE a FINER.

5.3 Device

This subsection describes how to configure the 2N[®] Indoor Touch launcher via the web interface.

Contents:

- 5.3.1 Network
- 5.3.2 Home Screen
- 5.3.3 Local Settings
- 5.3.4 Display
- 5.3.5 Audio
- 5.3.6 Maintenance

5.3.1 Network

This tab includes the Ethernet adapter settings in 2N[®] Indoor Touch.

LAN

DHCP is enabled: Yes

| | | |
|--|--|---------------------------------------|
| <p>IP address 10.0.25.209</p> | <p>IP gateway 10.0.25.1</p> | <p>IP DNS 10.0.100.102</p> |
| <p>IP mask 255.255.255.0</p> | | |

CHANGE SETTINGS

- **DHCP is enabled** - Yes/No - displays whether it is allowed/disallowed to get setting from DHCP
- **IP Address** - current IP address
- **IP Mask** - current mask
- **IP Gateway** - current gateway
- **IP DNS** - DNS server used
- **Change Settings** - display a setting changing dialogue
 - **Enable DHCP** - enable/disable getting of settings from DHCP; when disabled, the remaining IOP addresses will be displayed
 - **IP Address** - device IP address setting
 - **IP Mask** - mask setting
 - **IP Gateway** - network gateway setting
 - **IP DNS** - DNS server setting

5.3.2 Home Screen

This tab helps you set application positions and icons. It also includes the list of all applications available in the system.



| Applications | | | | | |
|---------------------|-----------------|-----------|---------------|-------------|--------------|
| USED | | MORE APPS | | | |
| Label | From | Version | Notifications | App Storage | Data Storage |
| QuickPic | alensw.com | 3.7.1 | true | 0 B | 0 B |
| OI File Manager | oponintents.org | 11.6 | true | 0 B | 0 B |
| 2N Helios IP Mobile | nn.cz | 4.3.3 | true | 29.1 MB | 1.4 MB |
| Browser | android.com | 4.4.4-22 | true | 0 B | 0 B |
| 2N* IP Audio | propc.cz | 1.0.12 | true | 14.4 MB | 0 B |













Click a selected position to display a position setting window:

Position settings 1
✕

Label
Gallery

Application
QuickPic ▼

Icon
Change Icon













Default icon

CANCEL CHANGE

- **Label** - application name to be displayed on a position.
- **Application** - click to display the list of applications installed in the device. Select an application to set its position in the launcher for launching.
- **Icon** - selected application icon.
- **Change Icon** - change an icon to another or the default one.



Caution

- It is impossible to remove the **Settings** and **About** icons from the Home Screen due to safety reasons. All you can do is duplicate them to other positions and then remove them from the original positions.

5.3.3 Local Settings

The tab helps you change the language, time zone and weather.

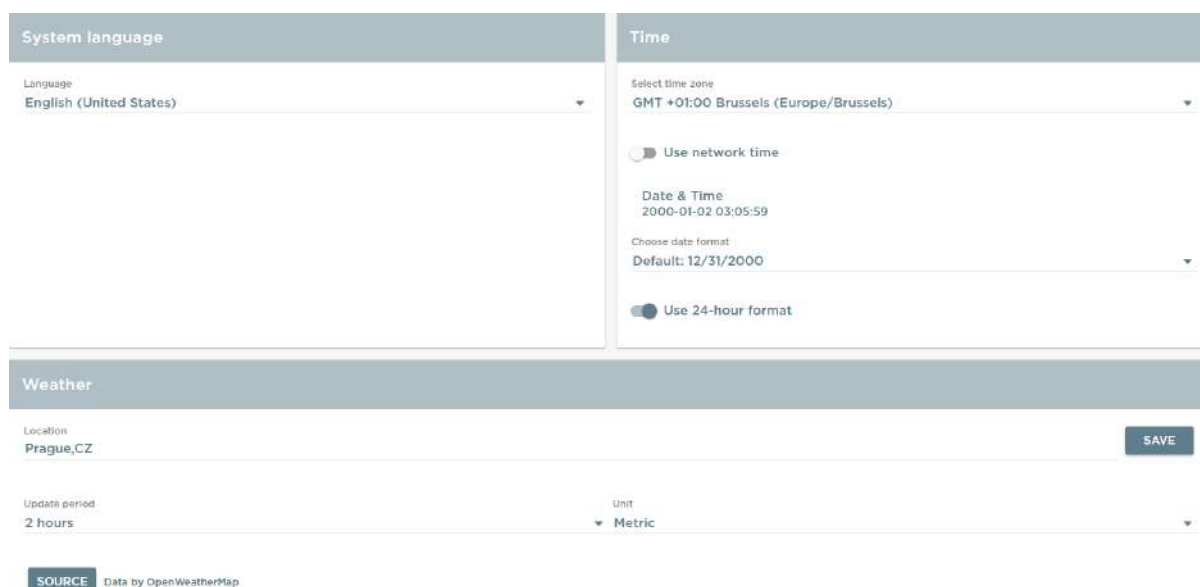

The screenshot displays the 'Local Settings' interface, divided into three main sections: 'System language', 'Time', and 'Weather'.

- System language:** A dropdown menu is set to 'English (United States)'.
- Time:**
 - 'Select time zone' is set to 'GMT +01:00 Brussels (Europe/Brussels)'.
 - 'Use network time' is a toggle switch that is currently turned off.
 - 'Date & Time' shows '2000-01-02 03:05:59'.
 - 'Choose date format' is set to 'Default: 12/31/2000'.
 - 'Use 24-hour format' is a toggle switch that is currently turned on.
- Weather:**
 - 'Location' is set to 'Prague,CZ' with a 'SAVE' button to the right.
 - 'Update period' is set to '2 hours'.
 - 'Unit' is set to 'Metric'.
 - A 'SOURCE' button is present, with the text 'Data by OpenWeatherMap' next to it.

- **System Language** – change the language of most applications (Gallery, etc.) excluding the launcher, which is in English by default and cannot be changed.
- **Time** – select the time zone. The default zone is GMT + 00:00.
- **Use network time** – select Use network time or Set time manually.
- **Date & Time** – click to enable manual date and time setting.
- **Date format** – set the date format.
- **Use 24-hour format** – select the time format: 12 h or 24 h.
- **Weather** – change the weather settings:
 - **Location** – weather forecast location in the format used at [OpenWeatherMap.org](https://openweathermap.org/).
 - **Save** – save the set location.
 - **Update period** – weather data update rate: 1 hour or 2 hours.
 - **Unit** – temperature units: Metric (°C) or Imperial (°F).
- **Source** – open the data source: [OpenWeatherMap.org](https://openweathermap.org/)

5.3.4 Display

The tab helps you control the display and LED notification settings.

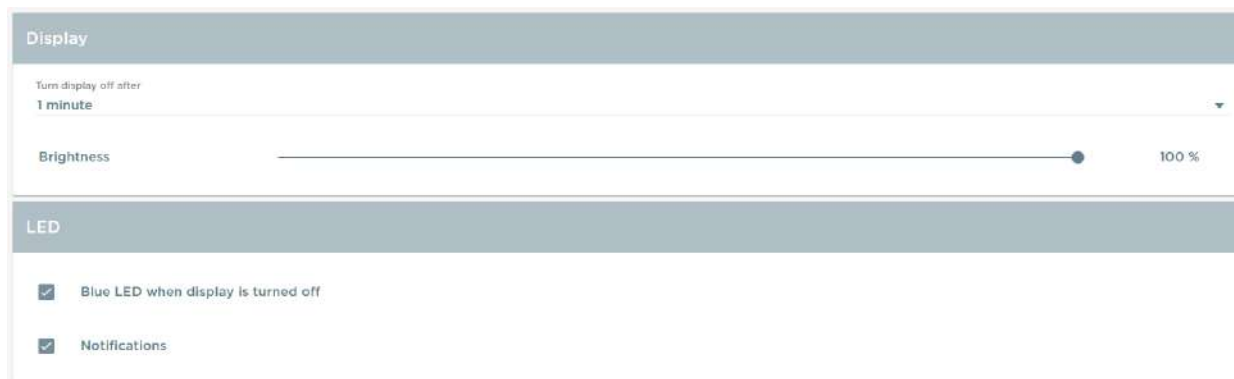

- **Display** – display settings:
 - **Turn display off after** – turn the display off after a pre-set time value: from 15 seconds to 30 minutes.
 - **Brightness** – set the display brightness: 10–100%.
- **LED** – set the LED notifications:
 - **Blue LED when display is turned off** – the blue LED goes on when the display turns off. This setting helps you distinguish whether it is the device or the display that is off.
 - **Notifications** – enable a red flashing LED to indicate an active notification from an application, typically a missed call from 2N[®] IP Mobile.

5.3.5 Audio

This tab helps you set the ringing, notification, application and other volumes.

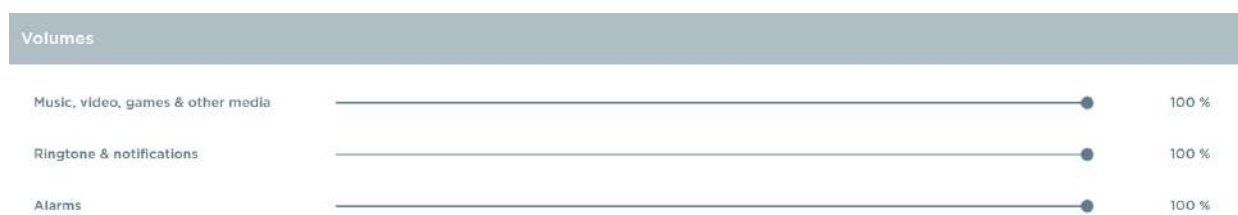

- **Music, video, games and other media** – set volume for music, video, games and audio from other similar sources: 7-100%.
- **Ringtone and notifications** – set volume for ringing and notifications: 14-100%.
- **Alarms** – set the alarm clock volume: 14-100%.

5.3.6 Maintenance

This tab helps you upgrade firmware, back up/download configuration and change passwords.

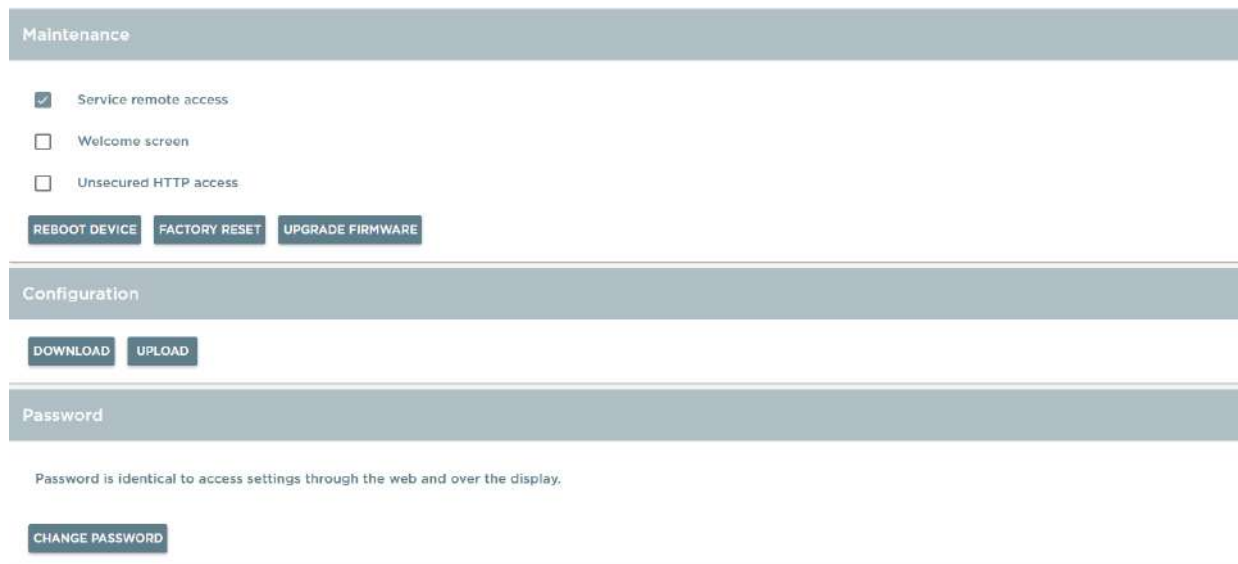

The screenshot shows the web interface with three main sections:

- Maintenance:** Contains three checkboxes:
 - Service remote access
 - Welcome screen
 - Unsecured HTTP access
 Below these are three buttons: REBOOT DEVICE, FACTORY RESET, and UPGRADE FIRMWARE.
- Configuration:** Contains two buttons: DOWNLOAD and UPLOAD.
- Password:** Contains a text field with the placeholder text "Password is identical to access settings through the web and over the display." and a button labeled CHANGE PASSWORD.

- **Maintenance**
 - **Service remote access** - enable access to the device via a web interface.
 - **Welcome Screen** - display the welcome screen upon every start.
 - **Unsecured HTTP access** - enable insecure login to 2N[®] IndoorTouch HTTP API. Used for analogue input/output control via HTTP API using the 2N IP Automation functions.
 - **Enable system restart** - set the automatic restart time for the device.
 - **Reboot device** - click to confirm reboot and initiate the device restart.
 - **Factory reset** - click to confirm reboot and initiate the device factory reset.
- **Upgrade Firmware** - display the firmware uploading dialogue and initiate restart+upgrade.

Upgrade Device Firmware



Select File **CHOOSE**

Firmware state
Not uploaded.

Running Version
2.0.3.0.0

CANCEL UPGRADE

- **Select File-Choose** - select the firmware file (.img).
- **Firmware state** - firmware upload status.
- **Running Version** - current firmware version.
- **Configuration**
 - **Download** - download the current configuration to a PC.
 - **Upload** - upload configuration from a PC file to the device. Click to display a dialogue to select whether to upload whole configuration or omit the IP address containing part.
- **Password**
 - **Change Password** - change the web interface and launcher configuration access password.

5.4 Application

This subsection describes how to change the 2N[®] IP Mobile configuration via a web interface.

Contents:

- 5.4.1 2N[®] IP Mobile
- 5.4.2 Settings

5.4.1 2N® IP Mobile

2N® IP Mobile settings.

- 5.4.1.1 Devices
- 5.4.1.2 Settings
 - 5.4.1.2.1 Common
 - 5.4.1.2.2 Password
 - 5.4.1.2.3 SIP Proxy
 - 5.4.1.2.4 Video
- 5.4.1.3 Info

5.4.1.1 Devices

This tab helps you display all devices added to 2N[®] IP Mobile and LAN and SIP Proxy devices added.

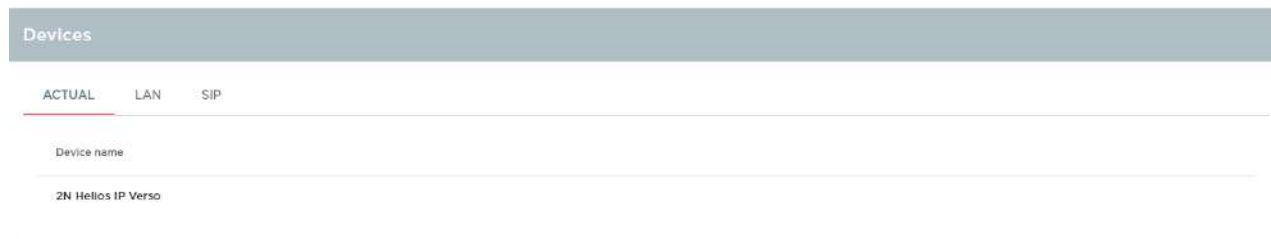

- **Actual** – display the devices added and information on them

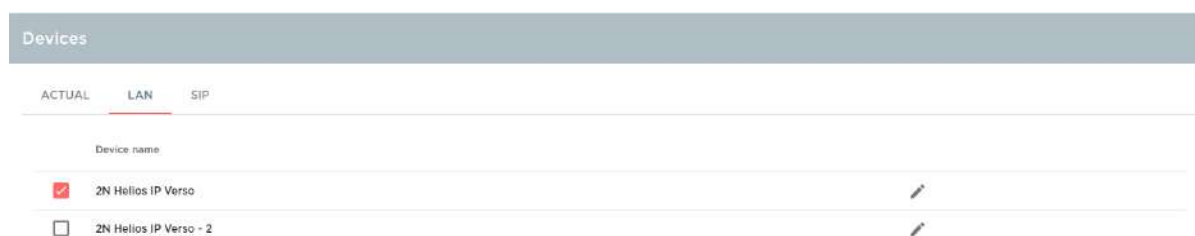

- **LAN** – display the devices detected in the LAN. Click to add a selected device to **Actual**. Click  to edit the device name.



- **SIP** – display the list of SIP Proxy devices added. Click  and complete the dialogue below:

Create device



Device name

SIP line

DTMF1

00*

DTMF2

00*

DTMF3

00*

DTMF4

00*

CANCEL

CREATE

- **Device Name** - display the SIP Proxy name.
- **SIP line** - display the SIP Proxy SIP line number.
- **DTMF1-4** - define the DTMF code to be sent to the called device during a call.

5.4.1.2 Settings

Other 2N[®] IP Mobile settings.

- 5.4.1.2.1 Common
- 5.4.1.2.2 Password
- 5.4.1.2.3 SIP Proxy
- 5.4.1.2.4 Video

5.4.1.2.1 Common

This tab helps you edit the 2N[®] Indoor Touch name to be displayed in 2N[®] IP Mobile and set the application start immediately after the launcher start.

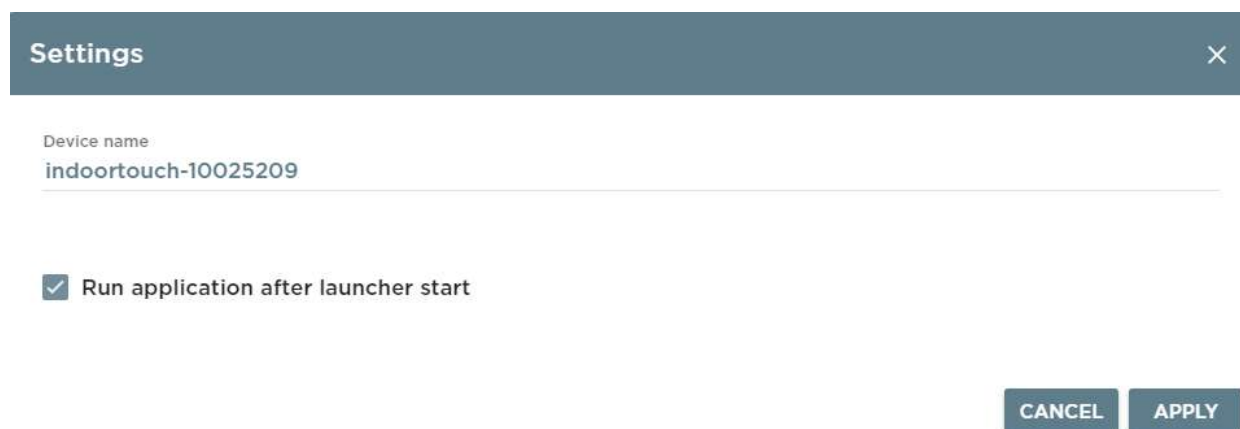

Settings

Device name
indoortouch-10025209

Run application after launcher start

CANCEL APPLY

- **Device Name** - device name in 2N[®] IP Mobile.
- **Run application after launcher start** - enable the 2N[®] IP Mobile start immediately after the launcher start.

5.4.1.2.2 Password

This tab helps you set the 2N[®] IP Mobile access password and the HIP Authentication Group password.

Settings ×

Password

2N HIP Group authentication

- **Password** - edit the 2N[®] IP Mobile access password.
- **2N IP Group Authentication** - edit the HIP Authentication Group password. Remember to set this password in **2N IP intercom** too.

5.4.1.2.3 SIP Proxy

This tab helps you set the parameters necessary for SIP Proxy server connection.



The screenshot shows a configuration window titled "SIP Proxy". At the top left, there is a toggle switch labeled "Proxy" which is currently turned on. Below it, the "Device name" is set to "IndoorTouch". The "User name" field contains "111" and the "Password" field is empty. The "SIP proxy" field is set to "192.168.1.1" and the "Port" field is set to "5060". At the bottom right, there are two buttons: "CANCEL" and "APPLY".

- **Enabled SIP** - enable/disable connection to SIP Proxy and set details.
- **Display Name** - display the 2N[®] IP Mobile device/application name for SIP Proxy needs.
- **User Name** - user name/number registered with the SIP Proxy server.
- **Password** - user password registered with the SIP Proxy server.
- **SIP Proxy** - SIP Proxy server IP address.
- **Port** - select the communication port. Default: 5060. Range: 1-65535.

5.4.1.2.4 Video

This tab helps you set the video stream parameters.

Settings ×

Local video receiving

Unicast

Multicast

Automatic video deactivation

2 minutes ▼

Early media

CANCEL APPLY

- **Local video receiving** – set the Unicast/Multicast video receiving mode
- **Automatic video deactivation** – set the time at which video transmission is to be deactivated: 1–30 minutes
- **EarlyMedia** – enable/disable media transmission before call setup

5.4.1.3 Info

This tab helps you restart 2N[®] IP Mobile and display information on the application state.

Info

Application is running: Yes

RESTART

- **Application is running** - Yes/No - application state
- **Restart** - restart the application

5.4.2 Settings

Set the functions necessary for other applications.

Settings

- Allow installation of 3rd party applications
- Allow return to application on call end

Application to run upon system start

URL to open upon system start

CHANGE SETTINGS

- **Allow installation of 3rd party applications** - enable installation of third party applications. This function is licensed.
- **Allow return to application on call end** - when a call comes while 2N[®] IP Mobile is running on the background and another application on the foreground, 2N[®] IP Mobile will return to the background after the call ends.
- **Package to run at start** - complete the package name of the application (*com.android.browser*, e.g.) to be started after the launcher start.
- **URL to run at start** - complete the URL to start the web browser and go to the specified address after the launcher start.
- **Change Settings** - change the settings in **Package to run at start** and **URL to run at start**.

5.5 Limitations

The web interface is always available to 1 user at a time. This applies to more tabs on 1 PC too. Therefore, remember to log in to each tab every time.

6. Technical Parameters

Power Supply

- **Type:** external power adapter (SELV type with LPS) 90–230 V, 50–60 Hz to 12 V DC 2 A Power over Ethernet (PoE 802.3af)
- **Power input:** up to 10 W

User Interface

- **Control:** capacitive touch panel
- **Display size:** 7"
- **Resolution:** 1024 x 600 px
- **Backlight:** LED
- **Status indicator:** 1 RGB LED

Audio

- **Microphone:** integrated
- **Loudspeaker:** 2 W integrated

OS

- **Android 4.4**

Interface

- **LAN:** 10/100BaseT, RJ-45; Cat5e or higher (recommended)
- **Memory card:** microSD card (SDHC) up to 16GB
- **WiFi:** 802.11b/g/n, integrated antenna
- **Card reader:** integrated

Mechanical Parameters

- **Dimensions (w x h x d):** 235 x 165 x 40 mm
- **Weight:** 850 g
- **Operating temperature:** 0°C - 60°C
- **Relative humidity:** 10% - 90% (non-condensing)
- **Storing temperature:** -20 °C - 70 °C
- **Recommended altitude:** 0-2000 m

I/O Description

- **HW v2**

| Signification | Name | Restriction |
|---------------|-------------|--|
| REL1/2 | Relay | contact data: max 30 V DC 1 A DC 12 V +/- IN = power input: Vinmax = 12 V DC Imax = 1 A DC 12 V + OUT = power output: Vout = 12 V DC Imax = 100 mA |
| DC12V+ | +12 V input | Imin = 1000 mA |
| DC12V- | -12 V input | Imin = 1000 mA |
| GND | Ground | |

- **HW v4**

| Signification | Name | Restriction |
|---------------|----------------------|--|
| ANALOG IN 1/2 | Analog Input | 0-5 V DC 1.5 MΩ |
| OUTPUT 1/2 | Digital Output | Voh = 3.3 V DC 0.33 mA |
| INPUT 1/2 | Digital Input | Vihmax = 5 V DC 100 kΩ |
| IN (OUT) 1/2 | Digital Input/Output | Vihmax = 3.3 V DC (100 Ω serial resistor), Voh = 3.3 V DC 4 mA (100 Ω serial resistor) |

| Signification | Name | Restriction |
|---------------|----------------------|--|
| REL1/2 | Relay | contact data: max 30 V DC 1 A. DC 12 V +/- IN = power input: Vinmax = 12 V DC I _{max} = 1 A. DC 12 V + OUT = power output: V _{out} = 12 V DC I _{max} = 100 mA |
| DC12V+ OUT | +12 V output | I _{max} = 100 mA |
| DC12V+ IN | +12 V input | I _{min} = 1000 mA |
| GND | Ground (-12 V input) | |

7. Supplementary Information

This section provides supplementary information on the 2N[®] Indoor Touch product.

Here is what you can find in this section:

- 7.1 Troubleshooting
- 7.2 Directives, Laws and Regulations - General Instructions and Cautions

7.1 Troubleshooting

Trouble: The device always switches off the display before timeout.

- **Advice:** Check the device temperature. If improperly installed, 2N[®] Indoor Touch automatically turns into the stand-by mode to reduce the device temperature if critical to avoid forced turn-off / reset in extreme cases. The user is notified of this problem by a short display of the notification window. Display the current device temperature in the Setting section.

Trouble: The device does not start and remains in one of the LED states or gets restarted round and round.

- **Advice:** Press and hold the Reset button on the device backside during the startup to restore the factory values automatically. If the trouble persists, upgrade the system via an SD card. If the trouble still persists, contact the Servicing centre.

Trouble: The device fails to emit sounds, even the incoming call ringing.

- **Advice:** Check the volume setting and adjust the loudspeaker volume level if necessary with the Volume up/down buttons on the lower status bar.



For the most frequently asked questions refer to faq.2n.cz.

7.2 Directives, Laws and Regulations - General Instructions and Cautions

2N[®] Indoor Touch conforms to the following directives and regulations:

2014/35/EU on the harmonisation of the laws of the Member States relating to the making available on the market of electrical equipment designed for use within certain voltage limits

2014/30/EU on the harmonisation of the laws of the Member States relating to electromagnetic compatibility

2011/65/EU on the restriction of the use of certain hazardous substances in electrical and electronic equipment

2012/19/EU on waste electrical and electronic equipment

Industry Canada

This Class A digital apparatus complies with Canadian ICES-003. / Cet appareil numérique de la classe A est conforme à la norme NMB-003 du Canada.

FCC

NOTE: This equipment has been tested and found to comply with the limits for a Class A digital device, pursuant to part 15 of the FCC Rules. These limits are designed to provide reasonable protection against harmful interference when the equipment is operated in a commercial environment. This equipment generates, uses, and can radiate radio frequency energy and, if not installed and used in accordance with the instruction manual, may cause harmful interference to radio communications. Operation of this equipment in a residential area is likely to cause harmful interference in which case the user will be required to correct the interference at his own expense.

Changes or modifications not approved by the responsible party could void the user's authority to operate the equipment.

Please read this User Manual carefully before using the product. Follow all instructions and recommendations included herein.

Any use of the product that is in contradiction with the instructions provided herein may result in malfunction, damage or destruction of the product.

The manufacturer shall not be liable and responsible for any damage incurred as a result of a use of the product other than that included herein, namely undue application and disobedience of the recommendations and warnings in contradiction herewith.

Any use or connection of the product other than those included herein shall be considered undue and the manufacturer shall not be liable for any consequences arisen as a result of such misconduct.

Moreover, the manufacturer shall not be liable for any damage or destruction of the product incurred as a result of misplacement, incompetent installation and/or undue operation and use of the product in contradiction herewith.

The manufacturer assumes no responsibility for any malfunction, damage or destruction of the product caused by incompetent replacement of parts or due to the use of reproduction parts or components.

The manufacturer shall not be liable and responsible for any loss or damage incurred as a result of a natural disaster or any other unfavourable natural condition.

The manufacturer shall not be held liable for any damage of the product arising during the shipping thereof.

The manufacturer shall not make any warrant with regard to data loss or damage.

The manufacturer shall not be liable and responsible for any direct or indirect damage incurred as a result of a use of the product in contradiction herewith or a failure of the product due to a use in contradiction herewith.

All applicable legal regulations concerning the product installation and use as well as provisions of technical standards on electric installations have to be obeyed. The manufacturer shall not be liable and responsible for damage or destruction of the product or damage incurred by the consumer in case the product is used and handled contrary to the said regulations and provisions.

The consumer shall, at its own expense, obtain software protection of the product. The manufacturer shall not be held liable and responsible for any damage incurred as a result of the use of deficient or substandard security software.

The consumer shall, without delay, change the access password for the product after installation. The manufacturer shall not be held liable or responsible for any damage incurred by the consumer in connection with the use of the original password.

The manufacturer also assumes no responsibility for additional costs incurred by the consumer as a result of making calls using a line with an increased tariff.

Electric Waste and Used Battery Pack Handling



Do not place used electric devices and battery packs into municipal waste containers. An undue disposal thereof might impair the environment!

Deliver your expired electric appliances and battery packs removed from them to dedicated dumpsites or containers or give them back to the dealer or manufacturer for environmental-friendly disposal. The dealer or manufacturer shall take the product back free of charge and without requiring another purchase. Make sure that the devices to be disposed of are complete.

Do not throw battery packs into fire. Battery packs may not be taken into parts or short-circuited either.



An Axis company

2N TELEKOMUNIKACE a.s.

Modřanská 621, 143 01 Prague 4, Czech Republic

Phone: +420 261 301 500, Fax: +420 261 301 599

E-mail: sales@2n.cz

Web: www.2n.cz

v3.4.x