

2N[®] Lift1

Communicator for lifts



User Manual

Version: 2.0.2

www.2n.cz

The 2N TELEKOMUNIKACE a.s. is a Czech manufacturer and supplier of telecommunications equipment.



The product family developed by 2N TELEKOMUNIKACE a.s. includes GSM gateways, private branch exchanges (PBX), and door and lift communicators. 2N TELEKOMUNIKACE a.s. has been ranked among the Czech top companies for years and represented a symbol of stability and prosperity on the telecommunications market for almost two decades. At present, we export our products into over 120 countries worldwide and have exclusive distributors on all continents.



2N[®] is a registered trademark of 2N TELEKOMUNIKACE a.s. Any product and/or other names mentioned herein are registered trademarks and/or trademarks or brands protected by law.



2N TELEKOMUNIKACE a.s. administers the FAQ database to help you quickly find information and to answer your questions about 2N products and services. On www.faq.2n.cz you can find information regarding products adjustment and instructions for optimum use and procedures „What to do if...“.



2N TELEKOMUNIKACE a.s. hereby declares that the 2N product complies with all basic requirements and other relevant provisions of the 1999/5/EC directive. For the full wording of the Declaration of Conformity see the CD-ROM (if enclosed) or our website at www.2n.cz.



The 2N TELEKOMUNIKACE a.s. is the holder of the ISO 9001:2009 certificate. All development, production and distribution processes of the company are managed by this standard and guarantee a high quality, technical level and professional aspect of all our products.



The 2N[®] is the holder of the Type certificate of the TÜV SÜD Czech company.

Content:

- 1. Product Introduction
 - 1.1 Product Description
 - 1.2 Components and Associated Products
 - 1.3 Changes
 - 1.4 Terms and Symbols Used
- 2. Description and Installation
 - 2.1 Product Description
 - 2.2 Before You Start
 - 2.3 Mounting – Universal Design
 - 2.4 Mounting – Compact Version
 - 2.5 Installation – Universal Design
 - 2.6 Installation – Compact Version
 - 2.7 Connection Methods
 - 2.8 Voice Alarm Station
- 3. Configuration
 - 3.1 2N® Lift1 Programming
 - 3.2 Table of Parameters
 - 3.3 2N® Lift1 Programming Tool
 - 3.4 SMS Configuration
- 4. Function and Use
 - 4.1 Function Description
 - 4.2 Service and Operating Staff Instructions
 - 4.3 Protocols CPC and P100
- 5. Service Tool
 - 5.1 Installation and Login
 - 5.2 Introduction to Application
 - 5.3 Use
- 6. Technical Parameters

- 7. Supplementary Information
 - 7.1 Troubleshooting
 - 7.2 List of Terms and Abbreviations
 - 7.3 Directives, Laws and Regulations
 - 7.4 General Instructions and Cautions

1. Product Introduction

In this section, we introduce the **2N[®] Lift1** product, outline its application options and highlight the advantages following from its use.

Here is what you can find in this section:

- 1.1 Product Description
- 1.2 Components and Associated Products
- 1.3 Changes
- 1.4 Terms and Symbols Used

1.1 Product Description

Basic Features

- 2N[®] Lift1 is primarily designed for lift installation - especially where there is one lift and no communication is needed between the lift cabin, machine room, shaft bottom and shaft roof (2N[®] Lift8 is designed for more complex installations).
- 2N[®] Lift1 is a Speakerphone on principle. This means that a microphone and an in-built (behind the lift button panel) speaker are used for bidirectional communication.
- 2N[®] Lift1 can be connected to a PSTN line directly. 2N[®] Lift1 is also powered from the PSTN line - requires **no battery** and thus **no maintenance**. 2N[®] Lift1 can also be connected to a PBX line or a GSM gateway (refer to Associated Products).
- 2N[®] Lift1 can be used for making calls to pre-programmed numbers and cannot be misused for "calling at somebody else's account".
- 2N[®] Lift1 can be equipped with various extending modules as necessary during and after purchase.

Advantages of Use

- Basic announcement set playing
- 30s lift identification announcement recording option
- Check call once in three days
- Remotely adjustable acoustic signal levels
- 2 LED indicators complying with the applicable lift regulations
- Function programming and check via phone
- On-hook and busy line detection
- Automatic redialling up to six phone numbers
- Protection against unintentional/useless startup (CANCEL)
- Call control from control centre
- No additional power supply requirement
- Easy installation into any lift button panel
- Certified for PSTN connection
- Amplifier module
- Lift blocking module
- Switch module (DTMF-controlled switches 1 and 2)
- Powerful indication options - illuminated pictograms (including bulbs)

1.2 Components and Associated Products

Basic Unit – Universal Design

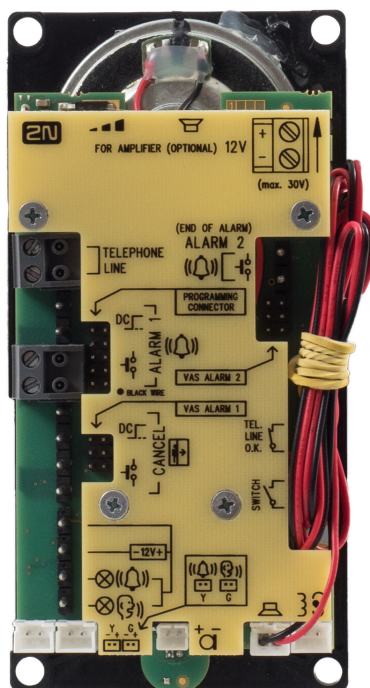

These units are installed behind the lift panel, which is prepared for installation in advance.

Part No., Name	Description
919640 2N [®] Lift1 – Cabin audio unit	<ul style="list-style-type: none"> • basic module (fully extendable) • automatic dialling of up to 6 numbers • factory announcements are played • own lift identification announcement recording option
919640X 2N [®] Lift1 – Cabin audio unit, cable version	<ul style="list-style-type: none"> • 919640 + LED, microphone and speaker connected with cables

<p>919618</p> <p>2N[®] Lift1 - Cabin audio unit with metal case</p>	<ul style="list-style-type: none"> like 919640 + stainless steel cover
--	---

Extending Modules and Components for 919640 Basic Units

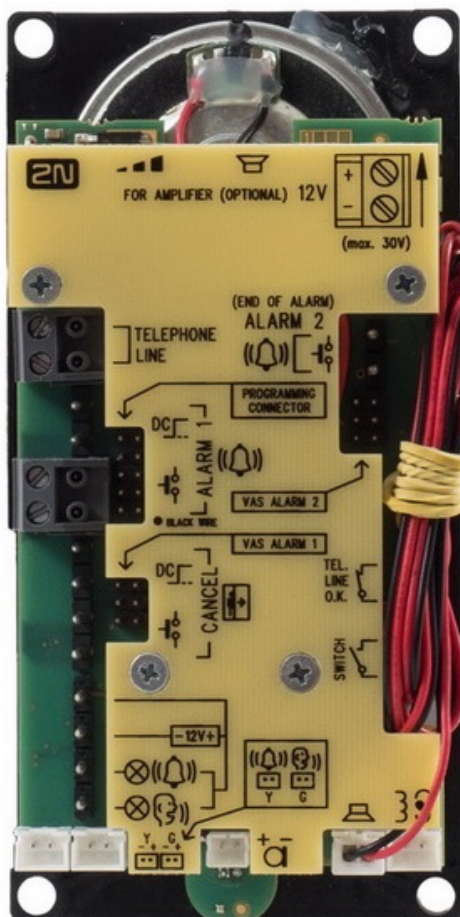

**Amplifier
913650E**



**Blocking module
913649E**



**Switch module
913648E**



**Induction
loop
919621E**

Part No., Name	Description
<p>913648E</p> <p>2N[®] Lift1 - Switch module</p>	<ul style="list-style-type: none"> A universal switch, remotely DTMF-controlled during connection. The installation includes two switches or one switch + one blocking module.

<p>913649E</p> <p>2N[®] Lift1 - Blocking module</p>	<ul style="list-style-type: none"> • A special switch that helps block a lift in the event of telephone line error.
<p>913650E</p> <p>2N[®] Lift1 - Amplifier module</p>	<ul style="list-style-type: none"> • An amplifier module with gain control. Designed for noisy environments, car lifts, etc.
<p>919630x</p>	<ul style="list-style-type: none"> • Metal case
<p>919631x</p>	<ul style="list-style-type: none"> • Extended metal case + Voice ALARM Station

Basic Unit - Compact Version



Part No., Name	Description
<p>919645E</p> <p>2N[®] Lift1 Compact</p>	<ul style="list-style-type: none"> • basic module • automatic dialling of up to 6 numbers • factory announcements are played • own lift identification announcement recording option
<p>919645WBE</p> <p>2N[®] Lift1 Compact</p>	<ul style="list-style-type: none"> • properties like 919645 • buttonless version

Programming Tool

Part No., Name	Description
919680E 2N [®] Lift1 Programming Tool	<ul style="list-style-type: none"> Used for interconnection of 2N[®] Lift1 and 2N[®] Lift1 Service Tool via USB.



Extending Modules - External



Part No., Name	Description
919654ESET Audio unit - machine room	<ul style="list-style-type: none"> • An extending set for the lift machine room. • Provides lift cabin communication and communicator configuration if necessary.



Part No., Name	Description
913660E 2N[®] Voice Alarm Station - Audio Unit	<ul style="list-style-type: none"> • An audio unit to be installed on the cabin roof and under the cabin.
913661E 2N[®] Voice Alarm Station - Switch	<ul style="list-style-type: none"> • A switch for interconnection with 2N[®] Lift1.



Part No., Name	Description
919621E Induction loop	<ul style="list-style-type: none"> • Provides lift communication to deaf people. • A 4m antenna for a good cabin signal, included in the package.



Part No., Name	Description
913646 External lift blocking module	<ul style="list-style-type: none"> • Blocks the lift function during telephone line failures.

Use the blocking module with **2N[®] Lift1** wherever you need to save the trailing cable wires. Install the module directly into the machine room through which the telephone line passes.

Associated 2N[®] Products

918xxx 2N[®] Lift8 System

- Up to 8 lift connectivity
- Cabin, shaft and machine room audio units
- In-built backup rechargeable battery
- Easy control and configuration via voice menu
- Check call function
- Lift blocking option during connection error
- Internal communication - Triphony
- Configuration via phone or PC (USB/Internet)
- USB interface
- User message recording option
- Local control option (InterCom)
- Fireman function

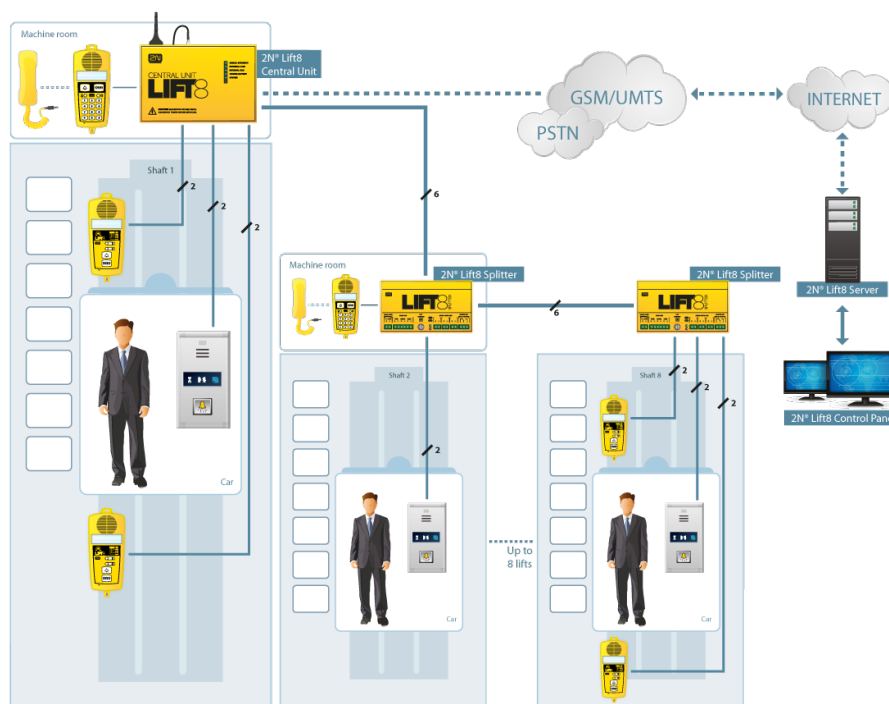

5013331E – 2N[®] EasyGate PRO GSM Gateway incl. 2N[®] Lift1 Backup Batteries

- Fixed telephone line substitution
- Easy installation, no configuration



501399 – 2N[®] EnergyBank Backup Power Supply for 2N[®] EasyGate (501303, 501313)

- Backup power supply for power outage
- Easy installation



Cooperating 2N[®] Applications

918700E 2N[®] Lift8 Control Panel

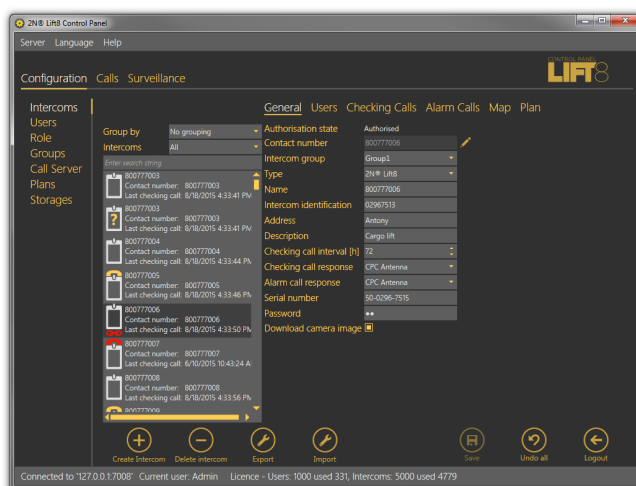

2N[®] Lift8 Control Panel

The 2N[®] Control Panel application is designed for management of users, lifts and rights.

918700E 2N[®] Lift8 Communicator

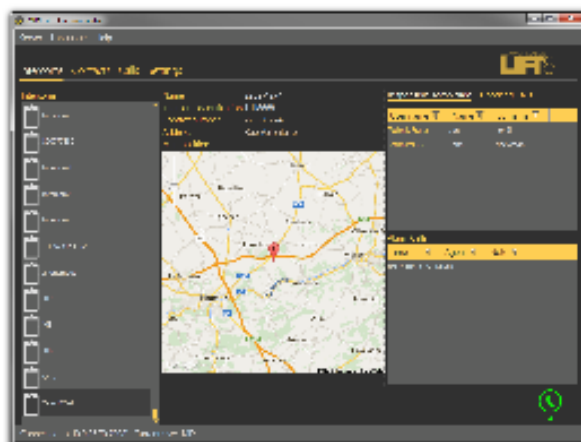

2N[®] Lift8 Communicator

The 2N[®] Lift8 Communicator application is designed for receiving alarm calls by Dispatcher.

918700E 2N[®] Lift8 Server

```

Správce: Příkazový řádek
c:\Program Files (x86)\2N TELEKOMUNIKACE\2N Lift8>cd Server
c:\Program Files (x86)\2N TELEKOMUNIKACE\2N Lift8\Server>18-config.exe -1
2N Lift8 Server Configuration Tool ver. 1.6.0.20.6
2N Lift8 Server status:
Running
Listing parameters:
2N Lift8 Server version: 1.6.0.20.6
Application data directory: 'C:\ProgramData\2N Telekomunikace\2N Lift8\Server'
2N Lift8 Server identification number: 3d837e4f
Database version: 29
Listen port: 7008
Log level: 3
Maximal number of TCP connections for users: 500
Maximal number of TCP connections for lifts: 2
1 license for 2436 hours (2076 used), 1000 users and 5000 lifts
License status: OK
c:\Program Files (x86)\2N TELEKOMUNIKACE\2N Lift8\Server>

```

2N[®] Lift8 Server

The 2N[®] Lift8 Server application processes check calls and mediates communication between the Central Units and PC applications.

1.3 Changes

The manufacturer reserves the right to modify the product in order to improve its qualities.

Manual version	FW version	Description of changes
1.0		<ul style="list-style-type: none"> • First product/manual version • Functional replacement of the 91364X series (2N[®] Single Talk)
	1.4.0	<ul style="list-style-type: none"> • New value 0 = unfinished call (parameter 912)
	1.6.2	<ul style="list-style-type: none"> • Time until the next checking call is activated (parameter 810) • DTMF tone duration (parameter 903) • Ringing periods for checking calls (parameter 955)
1.6.4	1.6.4	<ul style="list-style-type: none"> • Rescue process (parameters 966–968)
1.7.0	1.7.0	<ul style="list-style-type: none"> • Rescue mode upgrade (parameter 967 change, 968 function change) • Low or error EG battery reporting (parameter 968) • ALARM button test (969)
1.7.0	1.7.0.7.3	<ul style="list-style-type: none"> • New parameter 963
1.7.1	1.7.1	<ul style="list-style-type: none"> • Operational call

2.0.0	2.0.0.0.7	<ul style="list-style-type: none"> • New HW (both Universal and Compact) • New CPC Antenna/KONE, P100 2N Ext protocols • Button 2 function change (Short/long press) • New parameter 811 (Check call manual setup) • New parameter 920 (Alarm button mode) • New parameter 970 (External gateway) • New parameter 987 (LED signalling according to EN81-28) • Parameter renumbering (971, 975, 976, 977 871, 875, 876, 877)
2.0.1	2.0.6.0.13	<ul style="list-style-type: none"> • New parameter 890 (Reset) • New parameter 921 (Alarm button push signaling) • New parameter 925 (Button 2 mode) • Button 2 function change • Change of parameter 962 default value to 3000 ms (Minimum Alarm button pressing time)
2.0.2	2.0.9.0.17	<ul style="list-style-type: none"> • Supported new CFG SMS with 2N[®] EasyGate (services 811, 890, 996, 997, 998) • New parameter 900 (Addition of special characters to dial-in) • Reading serial numbers during calls via DTMF 9

 **Caution**

- The manufacturer keeps upgrading the software according to the customers' needs. Refer to www.2n.cz for the latest PRODUCT software version and manual.
- Refer to the Service Tool section for the 2N[®] Lift1 firmware upgrade details.

Symbols

The following symbols and pictograms are used in the manual:

Safety

- Always abide by this information to prevent persons from injury.

Warning

- Always abide by this information to prevent damage to the device.

Caution

- Important information for system functionality.

Tip

- Useful information for quick and efficient functionality.

Note

- Routines or advice for efficient use of the device.

2. Description and Installation

In this section, we describe the **2N[®] Lift1** product and its installation.

Here is what you can find in this section:

- **2.1 Product Description**
- **2.2 Before You Start**
- **2.3 Mounting – Universal Design**
- **2.4 Mounting – Compact Version**
- **2.5 Installation – Universal Design**
- **2.6 Installation – Compact Version**
- **2.7 Connection Methods**
- **2.8 Voice Alarm Station**

2.1 Product Description

2N[®] Lift1 is a Speakerphone on principle. It is equipped with a microphone, speaker, phone line terminals, ALARM button, illuminated pictograms (according to standard requirements) and CANCEL input (optional cabin door opening signal).

2N[®] Lift1 is available in two versions. **The Universal version** is designed for mounting behind the pre-drilled (according to the drawing, see the Mounting section) lift panel. **The Compact version** is provided with a metal case and can be installed quickly and easily without advance preparation.

Operation

Press the ALARM button to activate the device. The "Wait" pictogram starts shining immediately. The "Connection established" pictogram starts shining when communication has been established.

Universal Design

The electronics board is located between the mounting panel and the cover printed with instructions (see the figure). The total dimensions are 65 x 130 x 24 mm. The speaker and microphone are mounted on the panel. There are basic (slide-on) terminals to the left and extending modules (lift blocking, switches) to the right.

The small connectors in the lower part are intended for induction loops (for hearing impaired persons) and LED indicators. Illuminated pictograms/icons (even with bulbs) can be easily connected to the device. The pictograms and the ALARM button are not included in the delivery as they are lift design elements.

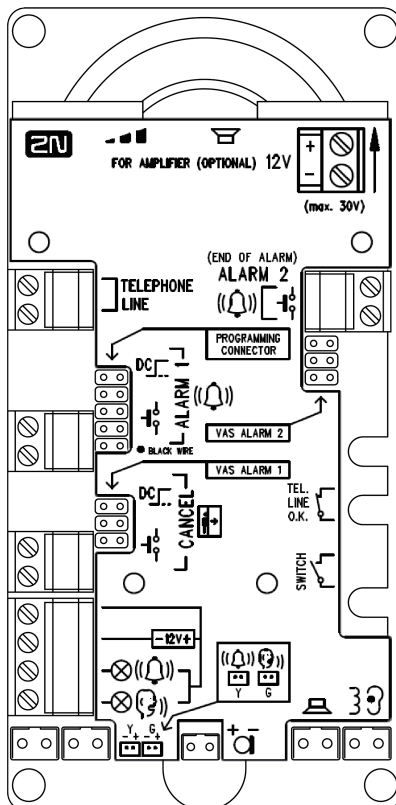

Compact Version

2N[®] Lift1 Compact is a robust, metal-encased audio unit equipped with an ALARM button of the prescribed size by default. In buttonless versions, an external button is connected as necessary. The audio unit is equipped with illuminated pictograms to signal the connection state and an induction loop for deaf people. It can easily be wall mounted without requiring precise wall cut-outs. It combines all the required lift communicator functions in the basic version. A PSTN or alternative (PBX, GSM gateway) line is used for connection with the control centre.

Press the ALARM button to activate connection. The "Wait" pictogram goes on immediately and the "Connection established" symbol goes out when communication has been set up. You can use automatic dialling of up to six pre-programmed numbers. Communication is accompanied by factory announcements and/or user recorded lift ID messages.



Caution

- The Compact version does not include the lift blocking module in the case of telephone line failure. You can connect the module parallel to the telephone line, e.g. in the machine room.

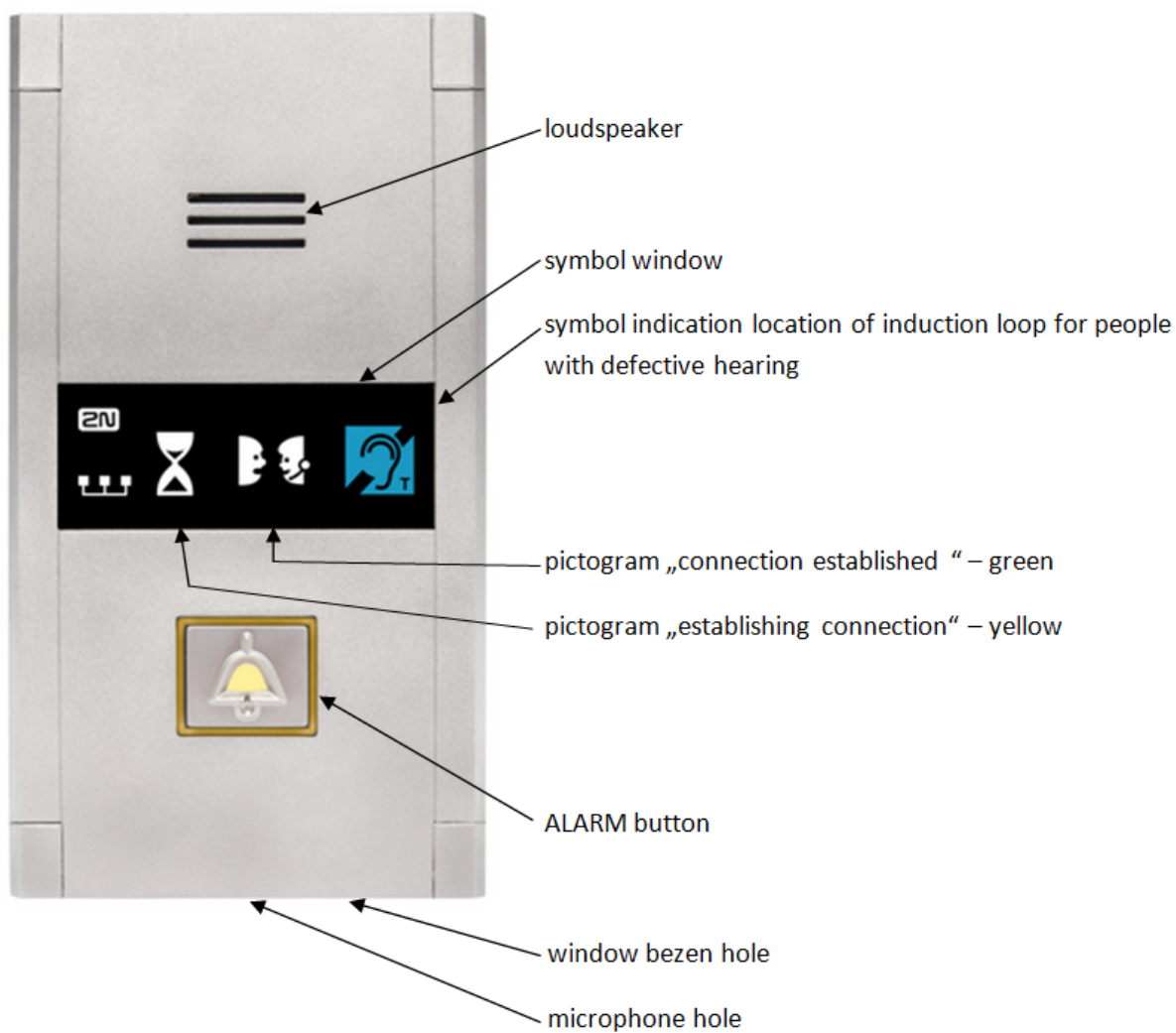

2.2 Before You Start

Product Completeness Check – Universal Design

Check before installation whether the product package includes the following:

- motherboard
- four terminals (line, ALARM, CANCEL, pictograms) slid to the left
- speaker and microphone (plus an additional cable microphone if required by the client)
- Brief manual (printed) and Warranty card
- download the 2N[®] Lift1 Service Tool from www.2n.cz

Product Completeness Check – Compact Design

Check before installation whether the product package includes the following:

- 1 Compact audio unit including the following parts (assembled):
 - window with label
 - 3 terminals slid into the back side connector
- 1x long 2 mm ballpoint hexagon key wrench
- 4x M4 x 8 screws
- 4x M4 x 30 grub screws
- 4x M4 nuts
- 4x fan-shaped washers

2N[®] Lift1 Installation Conditions

- 2N[®] Lift1 is not intended for outdoor applications.
- As the product is connected to a telephone line and may thus produce life-endangering voltage, follow the safety precautions - refer to Electric Installation.
- Never connect 2N[®] Lift1 to a line in parallel with another terminal device.
- The covering against mechanical damage, water, dust and other influences must be provided by installing company, if necessary.
- The surface for the communicator assembling must be perfectly flat, for details see chapter 2.3 or 2.4 - Installation.

✔ **Tip**

- Use a portable phone to make sure that the telephone line works.
- Make sure that you know the telephone line number and make a test call.
- Check the other important conditions mentioned in **2N[®] Lift1** Connection Methods before connecting a PBX line.

Universal Design

- Make sure that the lift panel is ready for **2N[®] Lift1** mounting.

2.3 Mounting – Universal Design

Safety Precautions

Safety

- The telephone line, microphone, speaker, LED indicators, ALARM button, CANCEL input, cables and electronics are connected with the telephone line. Therefore, make sure that the product installation prevents any contact between the user and these parts to avoid electrical accident. Keep the isolation distance of 1.5 mm at least or insulation breakdown voltage of 1500 V at least!

Caution

- Make sure that the position, appearance and marking of the communicator controls (ALARM button, e.g.) are in accordance with the applicable lift standards.

2N[®] Lift1 Position

2N[®] Lift1 can be mounted in any position as required. The optimum position for 2N[®] Lift1 is approximately on the level of an adult's mouth. Install 2N[®] Lift1 on a place where any contact of the operating personnel with the device is eliminated (refer to Safety Precautions).

Caution

- Installing electronics without the mounting panel is not recommended as the panel is used as electric insulation and the manufacturer cannot guarantee safety if the panel is not used.

2N® Lift1 Electronics Panel Mounting

What you need to mount the electronics panel onto the lift button panel (from inside): four 57×122 mm spot-welded M4 screws and sufficiently perforated speaker area (may be larger than as shown in the figure but **may never exceed the panel size** to avoid acoustic fault), microphone hole and two LED holes if necessary.

Mounting Drawing for 50 mm Speaker Installation

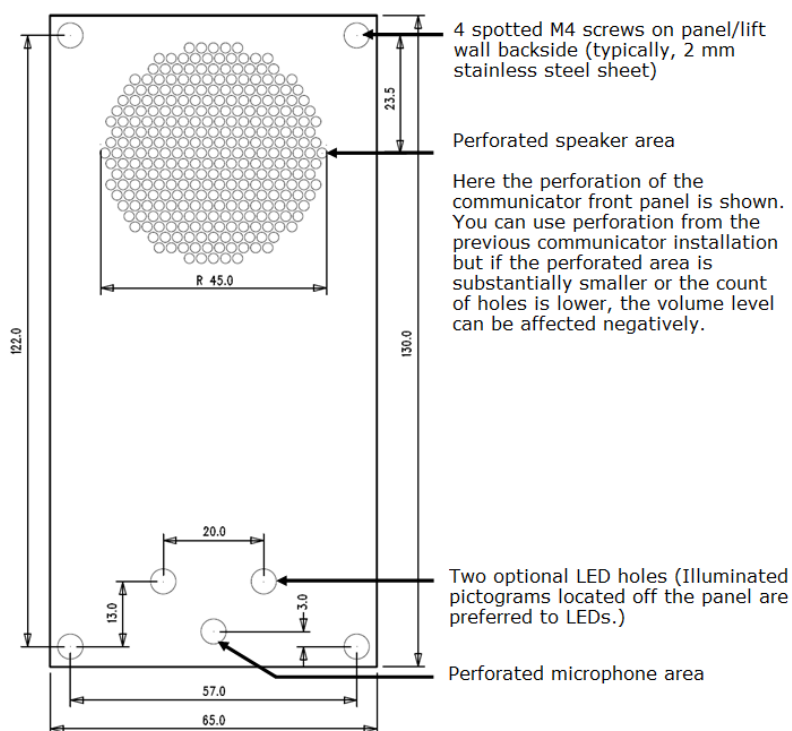

Mounting Drawing for 40 mm Speaker Installation

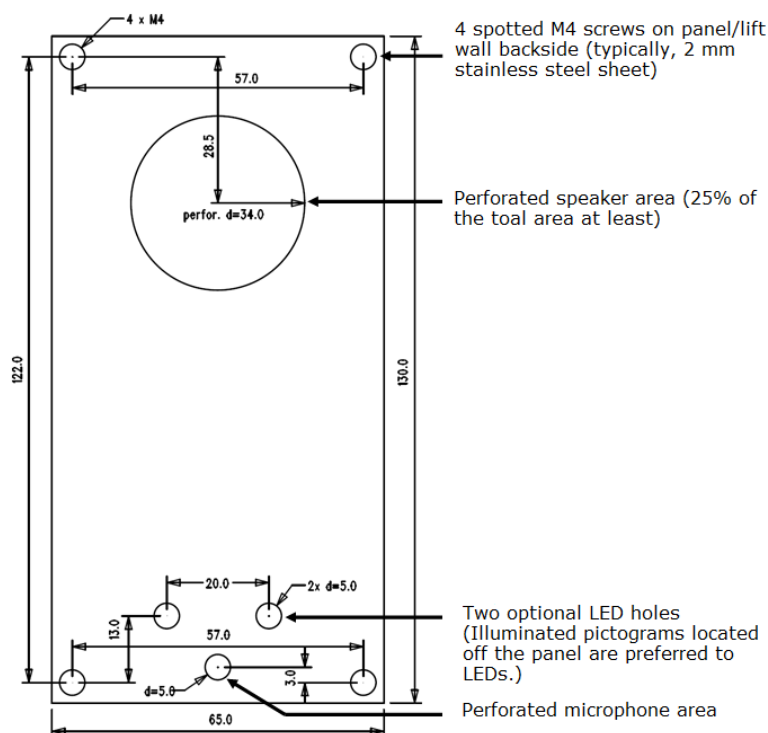

If you use other than the prescribed screws, make sure that the isolation distance between the electronics and substandard fitting elements is 2 mm at least. Make sure that the panel is fitted perfectly to avoid resonance during operation. There may be no gap between the lift button panel and 2N[®] Lift1 or the gap must be sealed properly to eliminate acoustic fault of the speaker and acoustic feedback between the speaker and microphone (see below).

Caution

- Make sure that microphone hole is sealed properly to record only sounds from the cabin instead of the noise from the shaft or space behind the panel.

Off-Panel Microphone Mounting

By default, the microphone is mounted directly on the printed circuit (see the drawing for its position). If required, the microphone can be supplied with a cable mounted on a 25 x 25 mm holder with self-adhesive foil. This allows you to mount the microphone behind any lift button panel hole of the minimum diameter of 3 mm or a group of holes of the same total area. The 2N[®] Lift1 microphone is on the board, but an external microphone can be connected via a connector. Switching to an external microphone is automatic (its connection is detected).

The minimum centre-to-centre distance between the speaker and microphone is 90 mm. A shorter distance may result in acoustic feedback. A longer distance does not matter.

Warning

- Make sure that the microphone hole is sealed properly against the noise from the gap between the lift cabin wall and mounting panel. The microphone should record sounds from the cabin instead of noise from the shaft or space behind the panel!

Off-Panel Speaker Mounting

By default, the speaker is mounted on a panel and equipped with a 1m cable for additional amplifier installation. You can also remove the speaker from its panel bed and place it separately. **In that case, respect the electric safety precautions, see below!**

Caution

- Installing the speaker separately, make sure that the grid cannot surpass the speaker dimensions in any case to eliminate the acoustic fault between the speaker front and back sides!

Safety

- If the speaker is installed separately, ensure the minimum electric isolation of 1500 V between the panel and speaker.
- Also, make sure that the isolation distance between the panel and speaker is 1.5 mm at least.
- Do not remove the rubber seal of the 40 mm speaker as it has an insulating function too!
- Mount the 50 mm speaker on an insulating (non-metallic) surface only or require an external panel (not included in the delivery), see the figure below.

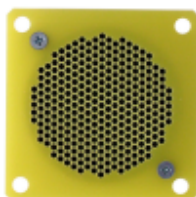

Caution

- We do not recommend you to install the microphone and speaker on completely different cabin sites (ceiling and wall, e.g.) to allow the users to find the microphone easily next to the speaker grid/perforation.

Indicator Mounting

There are three types of 2N[®] Lift1 state indicators:

1. Illuminated pictograms are part of the cabin control panel.
2. LEDs on the 2N[®] Lift1 electronics plus optional light guides conducting light to two panel holes.
3. Two optional highly luminuous LEDs can be connected to 2N[®] Lift1 via a cable.

Safety

- If you connect two optional LEDs with a cable, make sure that the electric isolation between the panel and speaker is 1500 V at least.
- Also, make sure that the isolation distance between the panel and speaker is 1.5 mm at least.
- It is prohibited to use standard metal LED holders, see the figure!



Note

- Make sure that your indicators comply with the applicable legal regulations. However, no indicators are necessary for the 2N[®] Lift1 communication.

2.4 Mounting - Compact Version

⚠ Accident Risk

- Make sure that the telephone line is supplied in such a manner that the user cannot touch the wires and is protected against electric accident by a minimum isolation distance of 1.5 mm or isolation of minimum breakdown voltage of 1,500 V.

Prior to Mounting

Mounting Preparation

Drill holes into the lift cabin wall according to the selected mounting type. If the cabin wall is accessible from the outside, you can use the corner holes for the M4 screws. If not, use the two holes in the middle for the bolts or make M4 threaded holes. See the 1:1 printing on the product package. The larger hole is intended for cable passage. Round the hole edges to avoid cable damage!

Mounting

The product mounting procedure may not be commenced until all electrical installations have been completed. Remove the connectors, screw the wires and replace the connectors for facilitation. Refer to **Mounting Completion** for further steps.

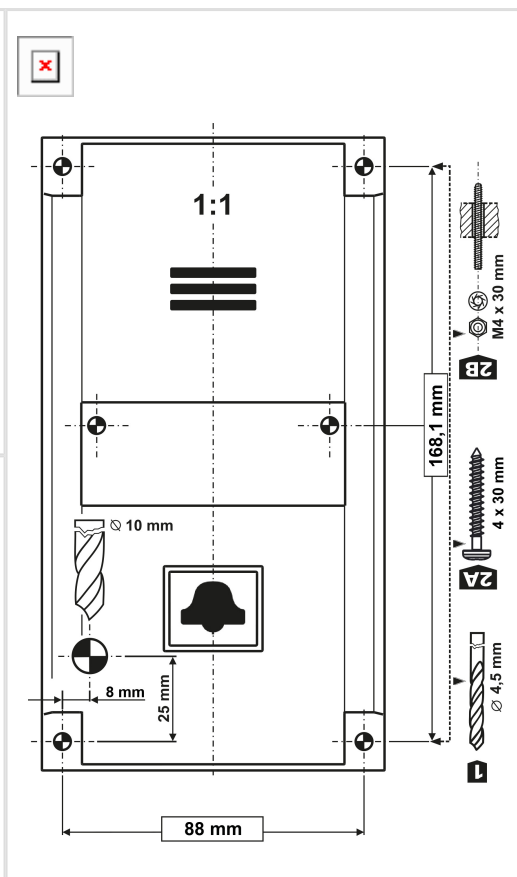

Safety

- The CANCEL, ALARM and Phone terminals and the electronics board are connected to a telephone line where life-endangering voltage may occur. Where switches are connected to the audio unit, make sure while mounting that the minimum isolation distance (from the telephone line connected parts) is 1.5 mm and/or the minimum breakdown voltage is 1,500 V. This applies to the switches too!
- The DC controlled terminals are separated from the telephone line and do not have to meet the isolation requirements mentioned above.
- Make sure that the cables cannot get in contact with sharp edges during installation to avoid insulation damage. Check the minimum isolation distance of 1.5 mm after installation using an isolation meter if possible.
- The manufacturer shall not be held liable for any installations made in conflict with these instructions.

2.5 Installation - Universal Design

Description of Terminals, Connectors and Jumpers

Terminals

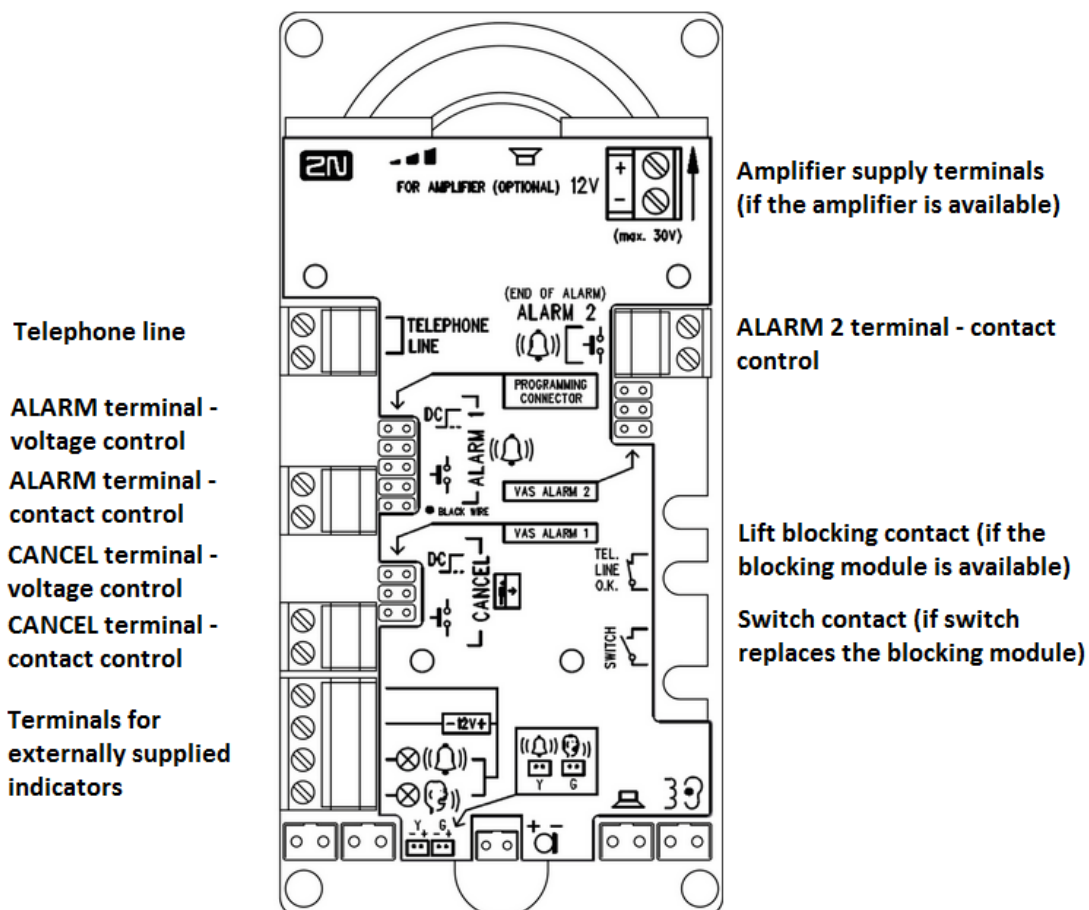

Note

- You can access the terminals without removing the cover.

Connectors Accessible after Cover Removal

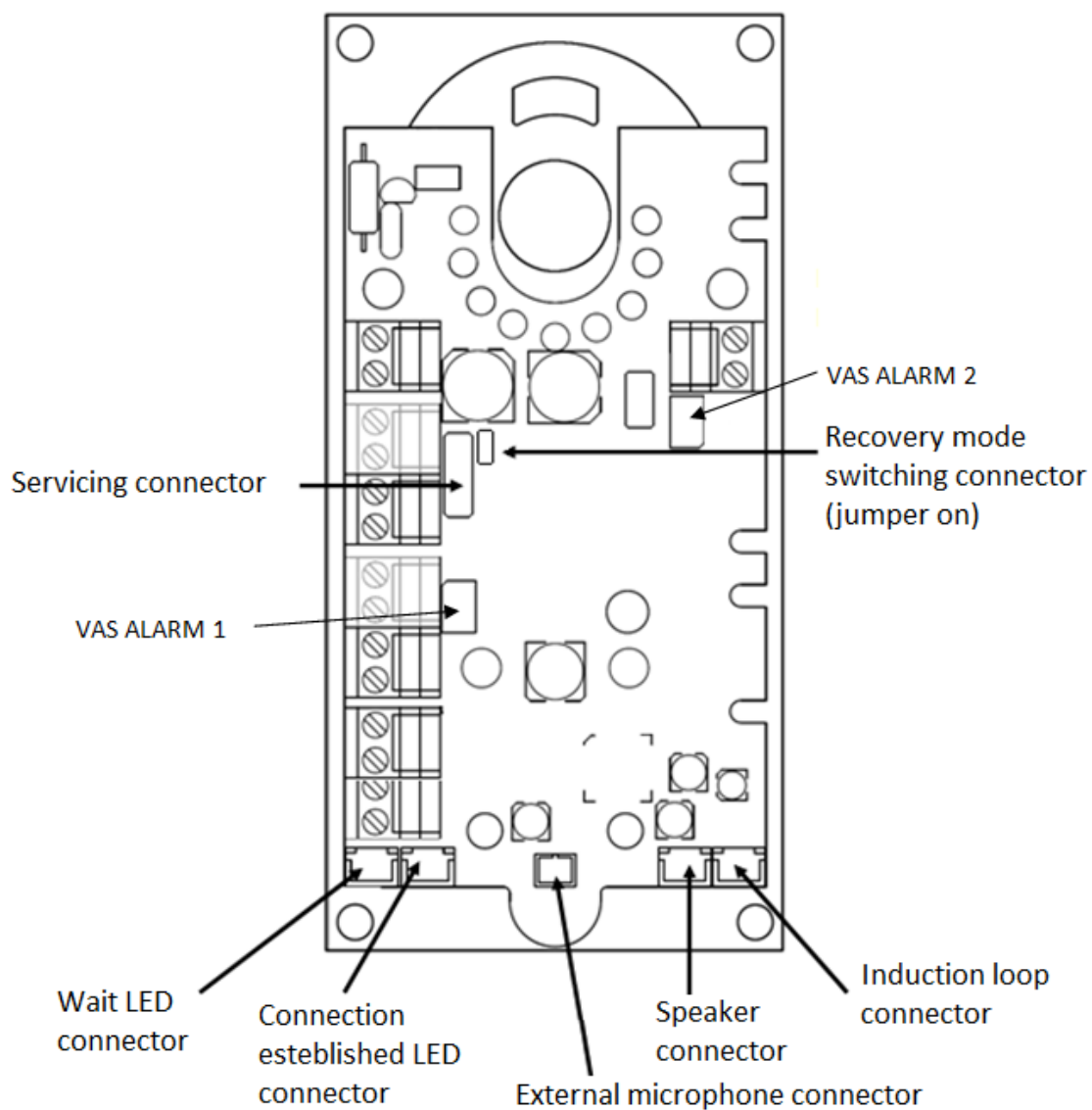

 **Tip**

- With HW2, the bottom connectors are accessible without the cover being removed.

Description of Terminals and Connectors

Telephone line		Polarity does not matter. Connect a PSTN, PBX or GSM gateway line directly. CAUTION - Never connect multiple devices to a single line!!!	
ALARM terminal	voltage control *)	6-24 V DC voltage, any polarity	Alarm call activation Activation mode (NO, NC, auto detection) is set by parameter 920.
	contact control	closing/opening contact	
CANCEL terminal	voltage control *)	6-24 V DC voltage, any polarity	Alarm call deactivation CANCEL input inversion is set by parameter 916.
	contact control	closing/opening contact	
Alarm 2 connector (button 2)		closing contact	Press button 2 (ALARM2) to set up a call to the numbers in memories 021-026 to end the rescue mode in case the rescue process is active and parameter 966 is set to 1 or 3.
Indicator terminals *)		Indicators (illuminated pictograms) - 12 V (up to 24V) / 2 x 200 mA, externally supplied, the wiring diagram must be maintained.	

"Wait" LED connector	yellow	LEDs are not part of the delivery by default (except for cable versions). Connecting an external LED deactivates the LED on the board.
"Connection established" LED connector	green	
VAS ALARM 1	Connection of Voice ALARM station - the call is set up to a number in memories 011-016 (ALARM 1)	Refer to Subs. 2.8 for details.
VAS ALARM 2	Connection of Voice ALARM station - the call is set up to a number in memories 021-026 (ALARM 2)	
External microphone connector	If an external electret microphone is connected (upon request), the integrated microphone is disconnected automatically.	
Speaker connector	The speaker is connected to this connector by default.	
Induction loop connector (optional)	<p>The induction loop is not part of the delivery by default. Install the loop behind a non-conductive non-metallic cover. Polarity does not matter.</p> <p>Notes:</p> <ul style="list-style-type: none"> • <i>Mounted behind a non-conductive non-metallic cover, the speaker works as an induction loop.</i> • <i>The output is resistant against short-circuit. The output power is limited by a resistor.</i> 	
Lift blocking contact *) **)	The contact opens whenever a power failure occurs. The lift arrives in the nearest floor and opens the door. The lift will not go on until the line function is recovered.	

Switch 2 contact *) **)	The switches are used for variable purposes and are remotely DTMF-controlled (numeric code). The switches are not designed for 230 V!
Switch 1 contact *) **)	
Button 2 connector	Button 2 is dedicated for a closing contact, it can be used for outgoing call activation or rescue end signalling.
Service connector	Used for connection of 2N [®] Lift1 to the 2N [®] Lift1 Service Tool via a USB socket changer (refer to Subs. 3.3 for details).
Recovery mode switching connector	<p>If there is a 2N[®] Lift1 - 2N[®] Lift1 Service Tool connection problem, put the jumper on this connector to switch 2N[®] Lift1 into the recovery mode for firmware upgrade.</p> <p>Connect the button 2 contacts for 5 seconds to reset the factory values. It is equivalent to parameter 999 and can be used if the service password gets lost. (Disconnect 2N[®] Lift1 from the telephone line and put the jumper on the connector to switch on the recovery mode. Now reconnect the telephone line and connect the contact for button 2 for 5 seconds. The green and yellow LEDs start flashing to indicate configuration recovery.)</p>

*) These terminals are safely electrically isolated from the telephone line.
 **) Extending module terminals. The blocking module can be mounted if switch 2 is not installed.

2N[®] Lift1 Connection to Telephone Line

2N[®] Lift1 works regardless of polarity and line parameters (refer to Technical Parameters). Connect it using the LINE terminals. A great advantage of 2N[®] Lift1 is that it requires no additional power supply for its function. Refer to 2N[®] Lift1 Connection Methods for PSTN/PBX/GSM connection details.

ALARM Connection - Contact Control

Safety

- Make sure that the ALARM button is safe - keep the isolation distance of 1.5 mm and breakdown voltage of 1500 V at least. Never connect the button contacts to any other circuits. If you cannot meet these conditions, use voltage control.

- Connect the button contacts to the ALARM terminal leaving the terminal in the lower position.
- The button can have a normally open/close contact or auto detection upon start. Use parameter 920 for setting.

ALARM Connection - Voltage Control

Tip

- Use 12-24 V DC voltage of any polarity. Make sure that the voltage supply is backed up against power failure.

- Slide the ALARM terminal out and put it in the upper position to ensure the required telephone line isolation.
- Activation can be made by connecting/disconnecting voltage or auto detection upon start. Use parameter 920 for setting.

Alarm 2 (Button 2)

Alarm 2 is used for call setup or rescue end.

Short press (approx. 100 ms) - to set up a call to the numbers stored in memories 021-022 (if empty, memories 011-016 are used).

Long press (approx. 3 s) - to end the rescue process if the rescue function is enabled (966 = 1,3). The yellow LED goes off (if Lift1 is fed with 12 V).

Indicator Connection

Basic Configuration

Use any indicators in this mode (illuminated pictograms/icons, e.g.). An external power supply provides the indicators with a sufficient brightness level. 2N[®] Lift1 contains switches only; current limitation, if required (for LEDs, e.g.), is ensured by a connected circuit. Unlike the LEDs supplied directly from the 2N[®] Lift1 electronics that do not shine during short-time on-hooks between automatically dialled calls (voltage cannot be detected from a hung-up line), the connection request indicator is illuminated during the whole connection setup time when external indicators are used.

Requirements

- 12–24 V power supply (backed up against power outage if required)
- Up to 200 mA continuous current (bulbs can be connected)
- Both the indicators must be connected!

Warning

- Maintain the power supply polarity!
- See the Lift1 cover for the wiring diagram.

2N[®] Lift1 Board Mounted LEDs

Do not connect anything in this case. Use light guides for this purpose to bring light to the two panel holes (refer to 2N[®] Lift1 Electronics Panel Mounting). The light guides are not included in the standard delivery.

Cable Connected LEDs

Use these LEDs where no illuminated pictograms are available. These LEDs are not included in the standard delivery. Order them separately or within a client solution. They are highly luminous LEDs of the diameter of 5 mm.

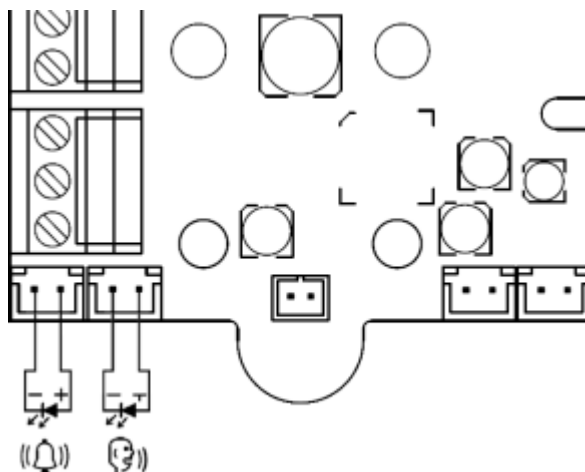

Requirements

- Maintain the LED polarity (see the cover printing).
- Keep the colours: request confirmation - yellow, connection confirmation - green.

Note

- The LED on the PCB is not illuminated in this configuration.

CANCEL Connection - Door Contact, Optional

Caution

- The door switch or door opening signal indicates that the door is open only if both the internal and external lift doors are open and people can leave the cabin.

Note

- To use the CANCEL input, program parameter 914 to a timeout longer than the maximum lift running time (i.e. the time during which the door is closed). If parameter 914 is set to 0, it is useless to set the CANCEL input connection.

Contact Control

Safety

- The CANCEL contact input is connected with the telephone line circuits. Therefore, make sure that the air gap between the switch and the other lift parts is 1.5 mm and the breakdown voltage is 1500 V at least. Make sure that the switch contacts are not connected to any other circuits. If these conditions cannot be met, use voltage control.

- Connect the switch to the CANCEL terminal leaving the terminal in the lower position.
- By default, 2N[®] Lift1 is configured for a switch that is closed when the door is open. If the switch is closed when the door is closed, set parameter 916 - refer to Programming).

Voltage Control

Use 12 to 24 V DC voltage of any polarity.

- Slide the CANCEL terminal out and put it in the upper position to ensure the required telephone line isolation.
- By default, 2N[®] Lift1 is configured for a sensor that applies voltage when the door is open. If the sensor applies voltage when the door is closed, set parameter 916 - refer to Programming).

Caution

- If voltage presence signals that the door is **closed**, make sure that the power supply is backed up against power outage.

Induction Loop Connection

Mind that the applicable regulations might require cabin installation of an induction loop for deaf people. The loop is connected to the 2N[®] Lift1 back side connector with any polarity or may be part of the delivery if agreed so, including a 4m cable.



Requirements

- You are recommended to install the induction loop behind a non-metallic, non-magnetic cover to avoid the loop radiation interference.
- Make sure that the induction loop is marked with a proper symbol (ear) and installed in accordance with the applicable standards.

Extending Module Installation

Extending Module Positions

Connect the module on the Lift1 right-hand side under the ALARM 2 button terminals.

Switch Installation

Install the Universal switch module (Part No. 913648E) before installing your 2N[®] Lift1 without removing the 2N[®] Lift1 cover. Slide the module into the cut-outs on the motherboard edges and tighten the two screws (through the panel holes).



Caution

- Make sure that **both** the screws are tightened properly!
- 2N[®] Lift1 can be equipped with a switch or a lift blocking module (never at the same time).

Warning

- In reality, the "contact" is represented by a semi-conductor with the resistance of approx. 0.5 Ω in the closed mode. Closing at a voltage value lower than 9 V may result in troubles – the switch function cannot be tested using a standard ohmmeter, which only uses small voltage for metering.
- The maximum current to be switched is 1 A. The switch is protected against higher current values with a resettable fuse.
- The allowed voltage is 9 to 24 V DC / AC. The switch is protected against surges with an overvoltage protector.
- The switch "contact" is safely electrically isolated from the telephone line, but is designed exclusively for low-voltage current applications: cannot switch 230 V / 120 V mains voltage.

Lift Blocking Module Installation

Install the Lift blocking module (Part No. 913649E) before installing your 2N[®] Lift1 (see the figure above) without removing the 2N[®] Lift1 cover. Slide the module into the cut-outs on the motherboard edges and tighten the two screws (through the panel holes).

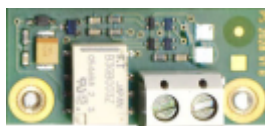

 **Caution**

- Make sure that **both** the screws are tightened properly!
- 2N[®] Lift1 can be equipped with a switch or lift blocking module (never at the same time).

Module function

The contact is closed when the telephone line is OK.

 **Caution**

- The module responds to telephone line disconnection with an up to 2-minute delay.
- The maximum current to be switched is 1 A. The maximum allowed voltage is 24 V. It is a mechanical contact (relay).

 **Warning**

- The module contact is safely electrically isolated from the telephone line, but is designed exclusively for low-voltage current applications: cannot switch 230 V / 120 V mains voltage.

Amplifier Installation

Follow the instructions enclosed to the amplifier delivery.

2.6 Installation - Compact Version

Caution

- Be sure to connect the wires before wall mounting. The connectors are separable - remove them, connect the wires, tighten the screws and replace the connectors.

Safety Precautions

- The product is connected to a telephone line where life-endangering voltage may occur, during storms in particular. Be sure to install the ALARM button in such a manner that the user cannot get in touch with the wires and can be protected against electrical accident. The minimum isolation distance must be 1.5 mm and/or the minimum breakdown voltage must be 1,500 V - for the used button too!
- Make sure that the cables cannot get in contact with sharp edges during installation to avoid insulation damage.
- Check after installation that the isolation distance of 1.5 mm is kept everywhere. Use an insulation meter if possible.
- The manufacturer shall not be held liable for any installations made in conflict with the User Manual or the Appendix thereto.

Electrical Installation

Terminals

The ALARM terminal block helps activate alarm calls. The ALARM button on the cover of button versions remains active even if an external button is connected or voltage control is used for activation.

Press button 2 (ALARM2) to set up a call to the numbers in memory 021-026 to end the rescue mode in case the rescue process is active and parameter 966 is set to 1 or 3.

The CANCEL terminal block helps deactivate an active alarm when the door opens. Therefore, set parameter 914 to a value higher than the maximum lift travelling time.

Terminals on the rear side

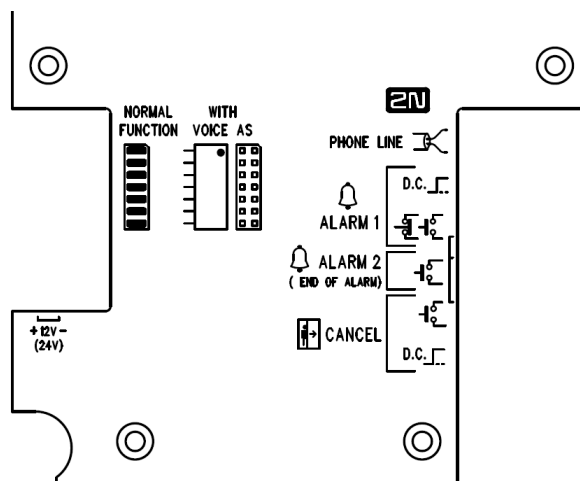

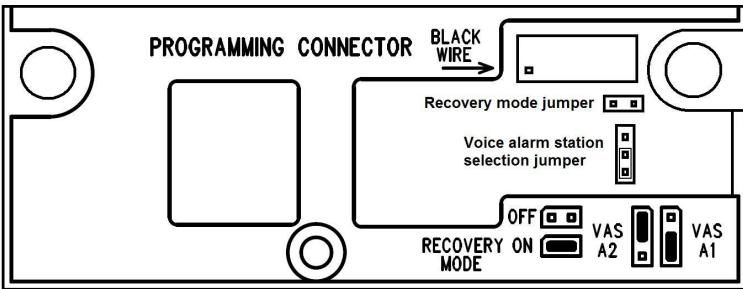
<p>Programming connector - use the 2N® Lift1 programmer to interconnect Lift1 with a PC and program it via the Service Tool.</p> <p>Recovery mode - refer to the Electric Installation table.</p> <p>The Voice Alarm Station selecting jumper defines the set of numbers to dialled by the Voice Alarm Station (011-016 or 021-026).</p> <p>VAS A1 - set 011-016</p> <p>VAS A2 - set 021-026</p>	<p>Connectors at front glass</p>  <p>The diagram shows a rectangular panel with several components: <ul style="list-style-type: none"> PROGRAMMING CONNECTOR: A rectangular port on the left side. BLACK WIRE: An arrow pointing to a specific terminal on the programming connector. Recovery mode jumper: A small rectangular component with two pins. Voice alarm station selection jumper: A component with two pins, used to select between VAS A1 and VAS A2. RECOVERY ON MODE: A switch with two positions, labeled 'OFF' and 'RECOVERY ON MODE'. VAS A2 and VAS A1: Two vertical components representing the Voice Alarm Station selection jumpers. </p>
--	---

Electrical Installation - Terminals

Connector / NAME		Description	
ALARM terminals	DC = voltage control	5-24 V DC, any polarity	Alarm call activation Activation mode (NO, NC, auto detection) is set by parameter 920.
	N.O. = NO contact / N.C. = NC contact	normally open contact / normally closed contact, if unused, a jumper is mounted	
Alarm 2	N.O. = NO contact	<p>Press the button shortly (approx. 100 ms) to set up a call to the numbers stored in memories 021-026.</p> <p>Press the button for a long time (approx. 3 s) to end the rescue process if activated (966 = 1,3).</p>	
CANCEL terminal	voltage control	5-24 V DC, any polarity	Alarm call deactivation upon door opening
	contact control	any contact	
connector WITH VOICE AS	connector mounted	normal function of 2N [®] Lift1	2N [®] Voice Alarm Station connector
	interconnection with Voice Alarm Station switch	used for connection of audio units under and above the lift cabin	
jumper RECOVERY MODE	recovery mode	<p>Set the jumper to ON to activate the recovery mode for FW upgrade whenever a problem occurs with the 2N[®] Lift1 - 2N[®] Service Tool connection.</p>	
connector PROGRAMMING CONNECTOR	for 2N [®] Programming Tool	USB programming tool for 2N [®] Service Tool via PC	configuration, firmware, voice menu
12V (24V)	DC voltage	After power connection, the Alarm button is backlit. If the rescue feature is activated, then the yellow LED is shining.	

Note

- Use 5–24 V DC of any polarity for voltage control. However, make sure that the source is backed up against power outage. You can also connect a buzzer or horn in parallel with the ALARM terminal if voltage control is used.
- You can also use the NO contact or voltage presence for CANCEL activation and invert the function using parameter 916 if necessary – NC contact or voltage absence for activation.
- Make sure that the DoorOpen signal is only activated when both the internal and external lift doors are open and the people can leave the cabin safely.

ALARM Connection

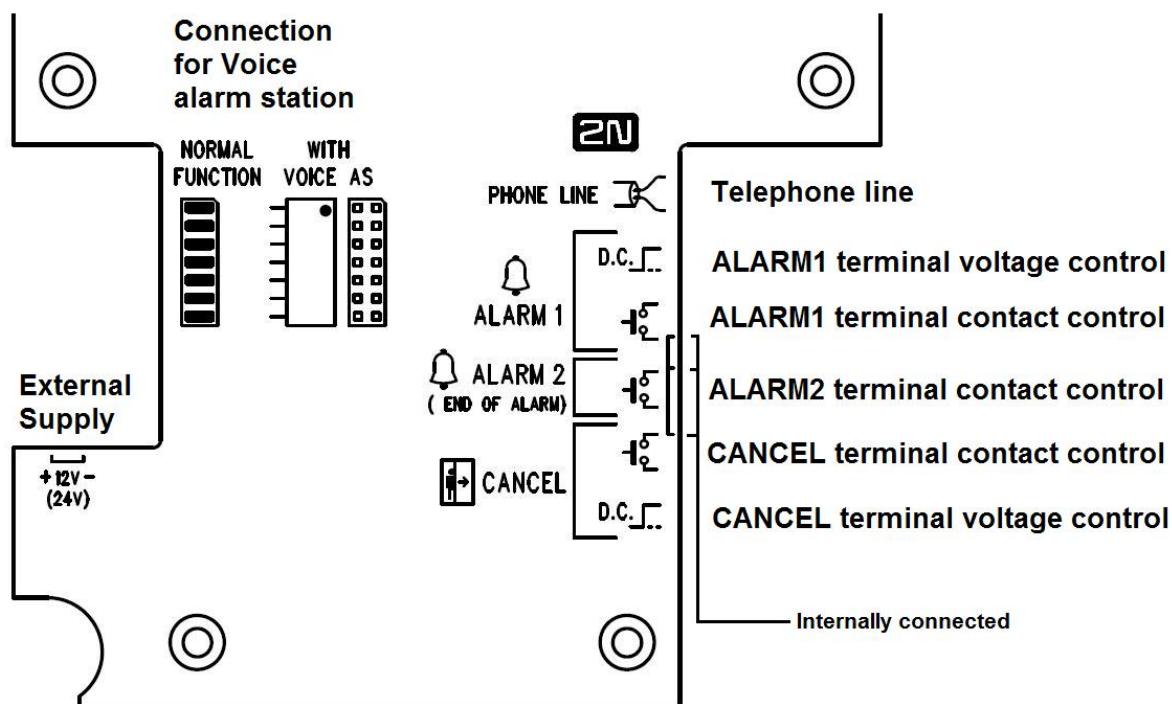

ALARM 1

Set alarm 1 using parameter 920 (Alarm button mode). The call is set up to the numbers in memories 011-016.

0 - normally open contact (Alarm is activated by closing the contact or presence of voltage on the input).

1 - normally closed contact (Alarm is activated by opening the contact or absence of voltage on the input).

2 - auto detection (the connected contact type is auto detected upon the next start, the parameter value is then changed to the type detected).

ALARM 2

Alarm 2 is controlled by the closing contact only. The call is set up to the numbers in memories 021-026 (if uncompleted, there is no fall to memories 011-016).

CANCEL

Set Cancel using parameter 916 (CANCEL input inversion).

0 - normally open contact (Cancel is activated by closing the contact or presence of voltage on the input).

1 - normally closed contact (Cancel is activated by opening the contact or absence of voltage on the input).

Warning

- It is impossible to connect multiple devices to a single line!!!

Tip

- The Compact version is very easy to install because the ALARM button, backlit pictograms and induction loop are part of the product. All you have to do is connect a telephone line. The CANCEL input connection is optional.

Alarm 2 (Button 2)

Alarm 2 is not available on the Compact audio unit until HW version 2. It is used for call setup or rescue end.

Short press (approx. 100 ms) - to set up a call to the numbers stored in memories 021-022 (if empty, memories 011-016 are used).

Long press (approx. 3 s) - to end the rescue process if the rescue function is enabled (966 = 1,3). The yellow LED goes off (if Lift1 is fed with 12 V).

Magnet-Controlled Reed Switch

The Compact HW version 2 is equipped with a magnetic reed switch in a glass envelope, which helps activate Alarm 2 or end the rescue process. The behaviour is like with Alarm 2 (button 2). This contact is in a glass envelope (to the right of the hourglass). Application of the magnet sets up a call or terminates the rescue process.

Telephone Line Connection

2N[®] Lift1 works regardless of polarity and/or line parameters in a wide range (see the Technical Parameters section). It is connected via the LINE terminals. A great advantage is that 2N[®] Lift1 requires no additional power supply for operation. For details on 2N[®] Lift1 connection to PSTN, PBX and GSM gateway lines refer to the 2N[®] Lift1 Connecting Options section.

CANCEL Input Connection (Door Contact, Optional)

The connection is the same as with the Universal version. Follow the instructions included in the **Installation – universal version** section, The only difference is that the terminal is in the upper position for contact control and in the low position for voltage control as printed on the rear cover at the terminals.

Induction Loop Connection

It is unnecessary to install the induction loop. It is integrated in the product, located to the right in the window area and labelled with the prescribed blue pictogram.

Mounting Completion

Having connected the wires, you can complete the 2N[®] Lift1 wall mounting. If you can access the cabin wall from the outside, use the mounting type that prevents dismantling and unauthorised tampering from the cabin. Mounting procedure:

- Where access from the outside is possible, use the four pre-drilled M4 holes in the corners.
- Remove the corner covers fitted with four M4 screws from behind.
- Screw the 30 mm long M4 headless grub screws included in the audio unit package in place of the corner cover screws removed. Tighten the screws with an internal hexagon key wrench.
- Put the audio unit on the holes, apply the serrated lock washers from the outside and screw the M4 nuts (both included in the delivery).
- This type of mounting is suitable for lift cabin wall thickness of up to 20 mm.



If you cannot access the cabin wall from the outside, use the screws under the pictogram glass:

- Insert the hex key wrench (included in the package) in the hole on the product bottom edge and turn it left (about 10 times) until it puts up resistance.
- The window slides down by itself or with little assistance, showing its upper brim.
- Tilt the window forwards and remove it.
- Now you have access to two holes in the window corners. Put **2N[®] Lift1** on the pre-drilled lift cabin wall holes and fit it with the included screws, which are suitable for plywood, chipboard, laminated plastic etc. walls. For other materials, use appropriate screws or M4 screws in the pre-drilled M4 threaded holes.
- Replace the window and insert the hex key wrench in the bottom edge hole turning it right about 10 times until the window slides under the panel edge. Tighten the window applying a moderate force.

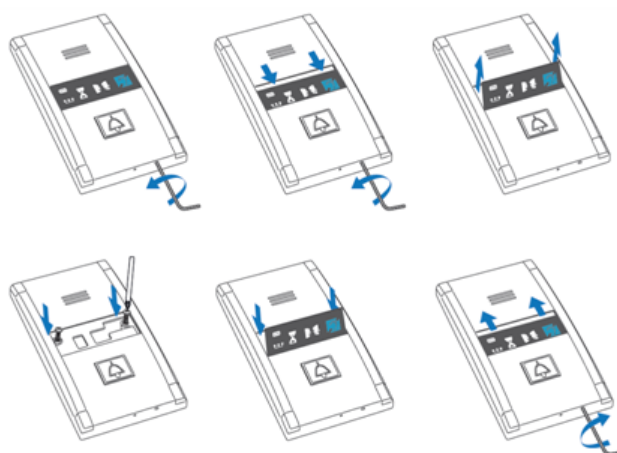

2.7 Connection Methods

Direct PSTN Connection

Advantages and Disadvantages

Direct PSTN connection is the easiest and most reliable method of connection. The purchase costs include the line acquisition cost, but the 2N[®] Lift1 operation is relatively cost-efficient (monthly fee).

Caution

- Make sure that the line is dedicated to 2N[®] Lift1 only and that no other terminal equipment is connected to it.
- The line must not be a dual or party line.

Note

- The telephone socket including the wires is the property of the telephone provider and may not be tampered with.
- Make sure that your follow-up cables meet the applicable safety regulations.
- Submit the 2N[®] Lift1 installation report and certifications if required.
- You are advised to protect your wires against piracy (use a phone lock, e.g.).

GSM Gateway Connection

Advantages and Disadvantages

GSM gateway connection is a rather expensive solution suitable for places without a telephone line.

Caution

- Back up the GSM gateway against power outage.
- Monitor the credit balance and top up your credit on time if you use a pre-paid SIM card.

Tip

- Check the local signal coverage and quality before choosing the GSM provider.
- Select the optimum antenna installation site.
- Use an external directional antenna for places with a poor signal quality.
- Ensure that the GSM gateway shall recover after power outage without requiring the PIN.
- Secure the GSM gateway SIM card against misappropriation.

PBX Connection

Advantages and Disadvantages

PBX connection is the cheapest solution for places where a PBX is installed and a free PBX line is available. Moreover, the 2N[®] Lift1 operational costs are zero if there is a well-trained staff continuously present in the building and 2N[®] Lift1 is programmed for exclusive connection with them.

 **Caution**

- Check the type of PBX power outage protection because non-backed-up PBXs transfer some of their lines directly to PSTN lines in the event of power failure and **2N[®] Lift1** would call other destinations if a prefix is used in this case! Refer to the Tips below for solution.

To ensure that **2N[®] Lift1** shall make successful outgoing calls (i.e. via PSTN), follow the instructions below:

- Make sure that the line to be used has the required authorisation (use a standard phone to check whether outgoing calls to the defined numbers can be made via this line).
- Complete the PSTN access prefix while programming (zero as a rule) or set a direct PSTN line seizure.
- Identify the line (extension) and type of incoming connection (dial-in, DISA, operator) and configure the PBX to allow for incoming **2N[®] Lift1** calls at night too (i.e. without operator).
- Set the required authorisation for the extension to be used for calling to a mobile network (GSM).
- Make an arrangement with the PBX owner as to operation financing (the **2N[®] Lift1** outgoing calls are at the owner's expense).

 **Tip**

- Operation financing can be solved by calling the "green lines" (prefix 0800).
- The so-called automatic PSTN seizure (requiring no dial-in) is a practical solution because being connected directly to a PSTN line during power outage, **2N[®] Lift1** will always call the right number.

2.8 Voice Alarm Station

Description

The 2N[®] Voice Alarm Station extends the 2N[®] Lift1 with an audio unit installed on the cabin roof and under the cabin. It is an **audio panel switch**, which interconnects 2N[®] Lift1 with one or two audio units.

2N[®] Lift1 – 919640, 919640X



Operation

Use Press to call to activate the device and set up a call to the number set in 2N[®] Lift1 (with VAS ALARM 1 setting, the call is set up to the ALARM 1 memories 011 to 016, with VAS ALARM 2 setting, the call is set up to the ALARM 2 memories 021 to 026).

Caution

- The audio unit does not contain any call-setup indicating LED. The LED on 2N[®] Lift1 is illuminated to indicate call setup and confirmation.
- It is necessary to wait for approx. 30 s for call setup from another audio unit. The switch remembers the last alarm-calling audio unit and when alarm is generated from another audio unit within 30 s, the call is set up from the audio unit that was the last to make the alarm call.

Mounting - Universal Design

Disconnect the speaker and microphone from the cables on 2N[®] Lift1 (external microphone if mounted).

Connect the cable connectors included in the delivery to the 2N[®] Lift1 microphone and speaker connectors (you cannot confuse the microphone/speaker connectors as they are of different size and there are clear pictograms on the audio unit cover). Put the 6-pin connector on the VAS ALARM 1 or VAS ALARM 2 jumper.

With VAS ALARM 1 connection, calls are set up to the numbers in ALARM 1 memories (011-016); with VAS ALARM 2 connection, calls are set up to the numbers in ALARM 2 memories (021-026).

Microphone and Speaker Connection

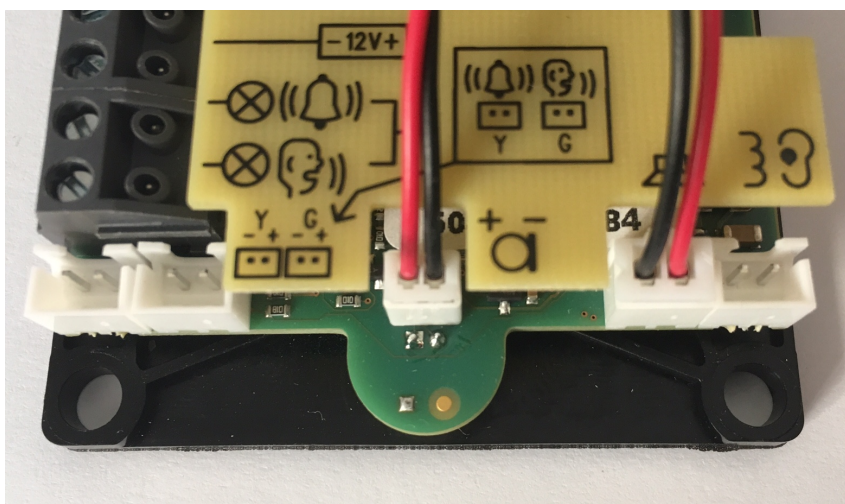

VAS ALARM 1

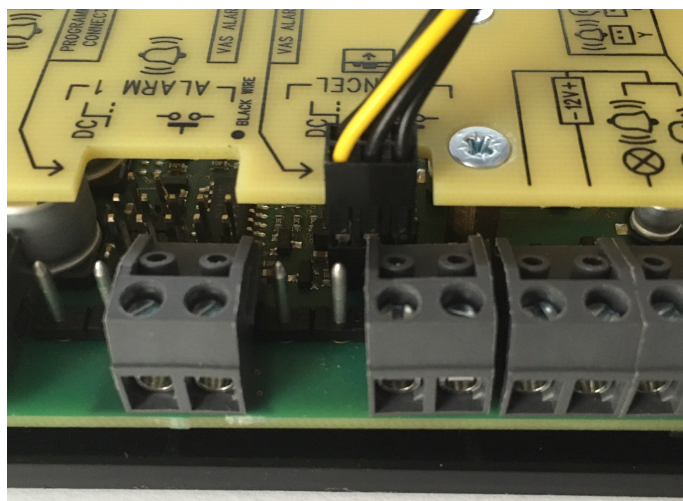

VAS ALARM 2

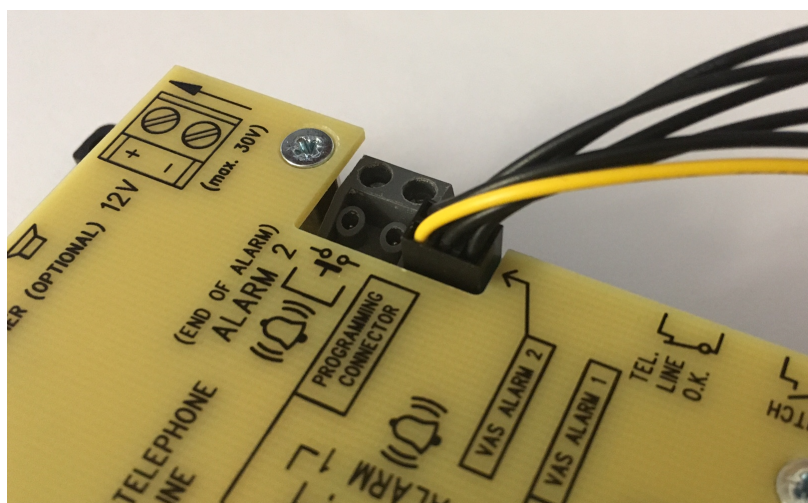

Warning

- Make sure that the 6-pin connection is correct to avoid product damage.
- Make sure that the yellow wire is up (when viewing the audio unit).

Remove the cover from the switch. Interconnect the switch and the 2N[®] Lift1 audio unit with the cable included in the delivery.



Connect the microphone and speaker from 2N[®] Lift1 in the point-switch. The speaker and microphone connectors are marked (SPK and MIC). Pull the cables through the holes.

 **Caution**

- In the case of a cable version of 2N[®] Lift1, an external microphone should be connected into the microphone input on the cable-switch. If you do not have a cable version, this input should be free.



Break out cable holes in the switch upper cover. Then replace the cover. There are 2 RJ12 connectors on the point-switch side for audio unit connection. Interconnect the audio unit and the switch using the cable supplied.

Mounting - Compact

The Voice Alarm station connector is located on the 2N[®] Lift1 Compact back side. Pull out the 14-pin jumper from the connector and replace it with the connector of the cable enclosed. Connect the 14-pin connector as shown in the back cover diagram (see the figure below).

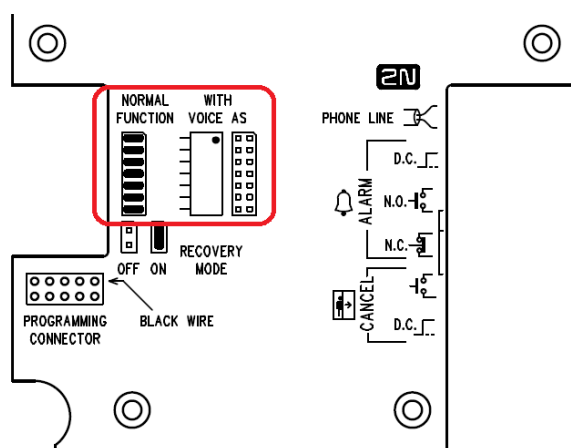

⚠ Warning

- Make sure that the 14-pin connection is correct to avoid product damage.
- Connect the connector as shown in the figure below. Make sure that the dot on the connector is up in the connection (when looking at the 2N[®] Lift1 Compact back side).

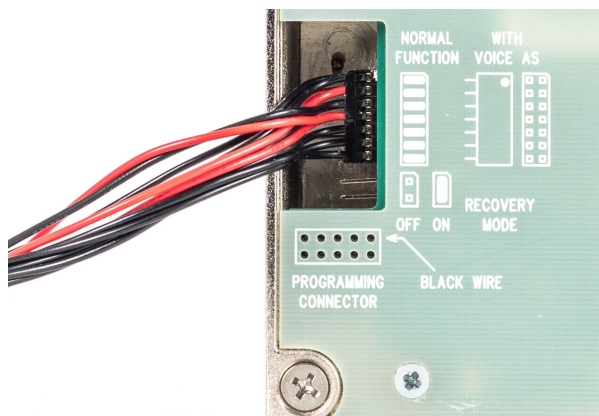

Remove the cover from the switch. Interconnect the switch and the **2N[®] Lift1 Compact** audio unit with the cable included in the delivery. Connect the 10-pin, microphone and speaker connectors in the switch (each of them has a different size and cannot thus be interchanged). The speaker and microphone connectors are marked SPK and MIC. Pull the enclosed cables through the holes.

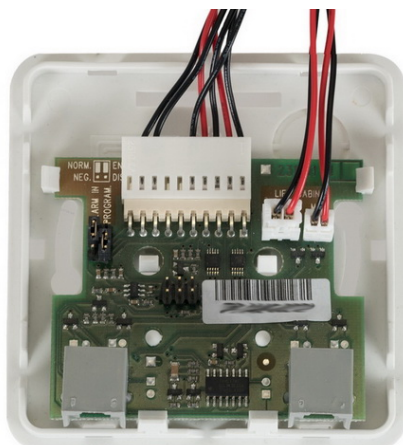

Break out cable holes in the switch upper cover. Then replace the cover. There are 2 RJ12 connectors on the point-switch side for audio unit connection. Interconnect the audio unit and the switch using the cable supplied.

2N[®] Lift1 Compact is configured to make calls to memories 011-016 (VAS ALARM 1) by default. To direct calls to memories 021-026 (VAS ALARM 2), shift the jumper under the glass.

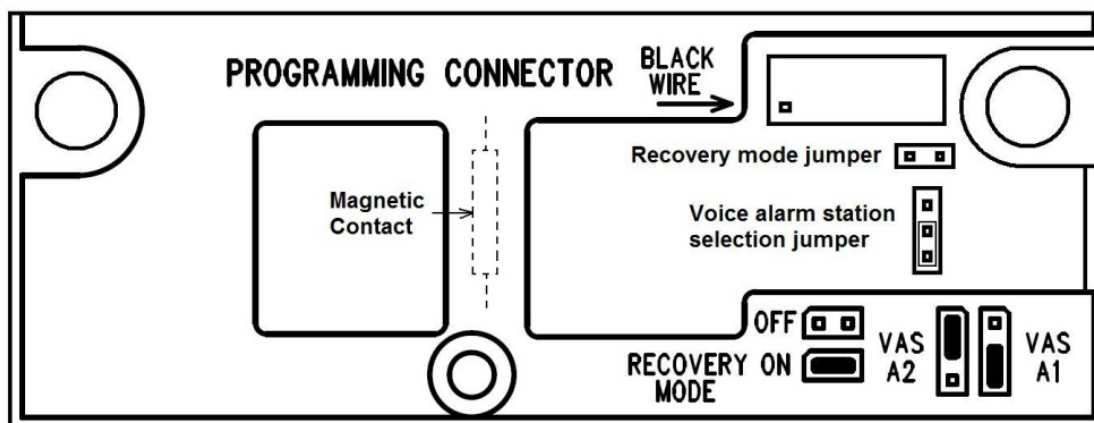

Dimensions

Audio unit - Voice alarm station: 225 x 87 x 67 mm

Audio panel switch: 81 x 81 x 30 mm

3. Configuration

In this section, we describe the **2N[®] Lift1** configuration.

Here is what you can find in this section:

- **3.1 2N[®] Lift1 Programming**
- **3.2 Table of Parameters**
- **3.3 2N[®] Lift1 Programming Tool**
- **3.4 SMS Configuration**

3.1 2N[®] Lift1 Programming

Before You Start

- Make sure that programming is enabled (jumper) and that your phone supports tone dialling.
- Complete all the values to be modified into a pre-prepared form, which provides a clear table of basic functions.
- If your 2N[®] Lift1 is not brand new, make sure that you have the correct service password and, if you are not completely sure of your 2N[®] Lift1 configuration, execute full initialisation (Warning: The service password will also be initialised!).

Access to Programming Mode

You can only enter the programming mode during an incoming call (from a phone to 2N[®] Lift1). Enter the access password:

 service password 

(remember to enter an asterisk in front of and behind the password!). If the password is correct and programming is enabled (jumper), 2N[®] Lift1 announces:

"You have entered the programming mode"

and displays a Help according to the context. The default password is **12345** and you are recommended to enter a different password to protect your device against unauthorised persons.

Tip

- If you forget your service password, contact the manufacturer to avoid data loss.
- While entering the password, keep a timeout of 5 seconds (or any other value in the range between 1 and 9) for each character to avoid 2N[®] Lift1 hang-up and password/function re-entering.



Programming Procedure

Having entered the programming mode, you can change any programmable value(s) in any order. Proceed as follows: enter the parameter number and value. Use an asterisk as a separator or Enter. In general, the function has the following format:

parameter number  value 

The parameter number has three digits (see the table). After you enter the number and an asterisk, 2N[®] Lift1 reports the number/name, current value and potential range of the parameter to be programmed. After you enter the value and another asterisk, 2N[®] Lift1 announces “New value stored”, or “Invalid value” if the value is beyond the allowed range.

Tip

- **Programmed value check:** enter the parameter number and , listen to the parameter value and press  to return to the main menu.



Caution

- A drawback of some phones is that they go “deaf” for a fraction of a second whenever you press a button, i.e. send DTMF. In that case, you cannot hear the whole text and are recommended to use another phone.

Programming Error

- If you make a mistake while entering a number (function or value) and find it before clicking the asterisk, press  to cancel the whole number and enter a new one.
- If 2N[®] Lift1 rejects a parameter number or value, you can go on programming - enter the function number although you typed a wrong value.
- If you have programmed and saved a wrong value, re-enter a correct value.

Programming End

- Having saved all the values to be modified, press  to make 2N[®] Lift1 send an on-hook signal and hang up.
- If you do not press , 2N[®] Lift1 will hang up later without affecting the value saving process (the values are stored immediately in the memory).
- If you are not quite sure of how 2N[®] Lift1 will behave after programming, save the filled-in form for later check.





Message Recording

Record a message in the **programming mode** (refer to Programming above). This mode is protected with a password or the "Programming disable" jumper if necessary.

Caution

- Change the setting of parameter 975 to play your message automatically when an outgoing call is made.

Procedure

1. Switch on the programming mode:  service password .
2. Enter the message recording command: 872  service password .
3. A continuous tone (up to 15 s) signals that the respective memory section is being deleted. Wait until the tone stops and you hear the confirmation tone .
4. Now 2N[®] Lift1 is recording the message of the maximum length of 30 s.
5. Press any digit (DTMF) on your phone to stop recording if your message is shorter than 30 s.
6. The recorded message is played back for check immediately.
7. Now go on programming.

i Note

- The maximum message length is 30 seconds, Therefore, we recommend you to prepare the text and test the message time in advance. Remember that the lift must be identified uniquely and that some messages are intended also for foreigners, in hotels, for example. Speak distinctly and loudly and watch the time while recording long messages.
- The message quality depends on the speaker (professional speakers are recommended for official announcements), phone (do not use HandsFree or obsolete carbon microphone telephone sets), ambient noise and connection quality (the best solution is to record a message via a PBX in advance).
- Message check: the message is played back for check immediately after recording.

Acoustic Settings

- In the 2N[®] Lift1 HandsFree mode, the sound path is muted when there is "silence" on both sides. When a certain sound level is exceeded, the speaker or microphone switches on depending on which party is speaking (or speaking more loudly).
- The optimum acoustic parameters are set by default and should be modified in exceptional cases only. Use parameters 933 through 935 to modify these values.





Switch Programming





- Passwords 00 and 11 are preset for the two switches (see the table). Remember to cancel the old password before entering a new one!
- You can program up to 6 different passwords for each switch. This allows you to assign various passwords to multiple persons and cancel any of the passwords without cancelling the others to disable a person if necessary.
- All passwords are checked during programming, i.e. it is forbidden to enter a password twice for one switch. However, you can enter one and the same password for either switch.
- If you want to use a quicker switch activation method (enter the password without the  characters), be careful while entering passwords of variable lengths: if the shorter password is identical with the beginning of the longer password, you cannot control the switch with the longer password. Moreover, the password should not begin with digits 1 to 5 if you use Automatic dialling with confirmation at the same time.

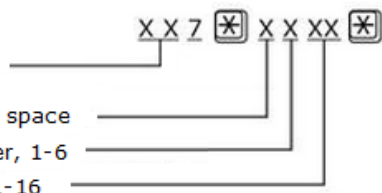





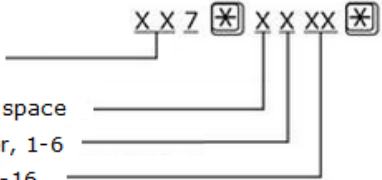



3.2 Table of Parameters











The table below includes all the 2N[®] Lift1 programming functions.

Table of Parameters

Par. No.	Parameter name	Range of values	Default value	Note	Info
011	ALARM button memory 1	up to 16 digits: 0-9	empty	Enter  ,  and 'p' for a 3-second pause while programming via the 2N [®] Lift 1 Service Tool or using parameter 017.	
012	ALARM button memory 2	up to 16 digits: 0-9	empty		
013	ALARM button memory 3	up to 16 digits: 0-9	empty		
014	ALARM button memory 4	up to 16 digits: 0-9	empty		
015	ALARM button memory 5	up to 16 digits: 0-9	empty		
016	ALARM button memory 6	up to 16 digits: 0-9	empty		
017	Insert specific character in ALARM memory	Entering format: Button number 01  1 =  2 =  3 = space Button memory number, 1-6 Character position, 01-16 Note: The digits behind this position are shifted automatically.			

Par. No.	Parameter name	Range of values	Default value	Note	Info
018	Count of automatic dialling cycles for ALARM	0-9	3	If 0 is set, only the first number in the memory is called regardless of the count of stored numbers.	
021	Button 2 memory 1	up to 16 digits: 0-9		<p>Enter ,  and 'p' for a 3-second pause while programming via the 2N[®] Lift1 Service Tool or using parameter 027.</p> <p>If the memories are not filled, no fall to memories 011-016 occurs.</p>	
022	Button 2 memory 2	up to 16 digits: 0-9			
023	Button 2 memory 3	up to 16 digits: 0-9			
024	Button 2 memory 4	up to 16 digits: 0-9			
025	Button 2 memory 5	up to 16 digits: 0-9			
026	Button 2 memory 6	up to 16 digits: 0-9			
027	Insert specific character in button 2 memory	<p>Entering format:</p>  <p>Button number 02</p> <p>1 =  2 =  3 = space</p> <p>Button memory number, 1-6</p> <p>Character position, 01-16</p> <p>Note: The digits behind this position are shifted automatically.</p>			
028	Count of automatic dialling cycles for button 2	0-9		If 0 is set, only the first number in the memory is called regardless of the count of stored numbers.	

071	Checking call memory 1	up to 16 digits: 0-9	empty	Enter  ,  and 'p' for a 1-second pause while programming via a PC (use 2N [®] Lift 1 Service Tool).
072	Checking call memory 2	up to 16 digits: 0-9	empty	
073	Checking call memory 3	up to 16 digits: 0-9	empty	
074	Checking call memory 4	up to 16 digits: 0-9	empty	
075	Checking call memory 5	up to 16 digits: 0-9	empty	
076	Checking call memory 6	up to 16 digits: 0-9	empty	
077	Insert specific character in check call memory	<p>Entering format:   7     </p> <p>Button number, 07 —————</p> <p>1 =  2 =  3 = space —————</p> <p>Button memory number, 1 – 6 —————</p> <p>Character position, 01 - 16 —————</p> <p><i>Note: The digits behind this position are shifted automatically.</i></p>		
078	Count of automatic dialling cycles for check call	0-9	3	If 0 is set, only the first number in the memory is called regardless of the count of stored numbers.

Par. No.	Parameter name	Range of values	Default value	Note	Info
081	Operational call memory 1	up to 16 digits: 0-9	empty	Enter  ,  and 'p' for a 1-second pause while programming via a PC (use 2N [®] Lift 1 Service Tool).	
082	Operational call memory 2	up to 16 digits: 0-9	empty		
083	Operational call memory 3	up to 16 digits: 0-9	empty		
084	Operational call memory 4	up to 16 digits: 0-9	empty		
085	Operational call memory 5	up to 16 digits: 0-9	empty		
086	Operational call memory 6	up to 16 digits: 0-9	empty		
087	Insert specific character in operational call memory	<p>Entering format:   7     </p> <p>First two digits of parameter number, 08 ————</p> <p>1 =  2 =  3 = space ————</p> <p>Button memory number, 1 – 6 ————</p> <p>Character position, 01 - 16 ————</p> <p><i>Note: The digits behind this position are shifted automatically.</i></p>			
088	Count of automatic dialling cycles for operational call	0-9	3	If 0 is set, only the first number in the memory is called regardless of the count of stored numbers.	

Par. No.	Parameter name	Range of values	Default value	Note	Info
111	Confirmation mode for number 1 (ALARM)	1-6	1	1 = loud with confirmation 2 = silent with confirmation 3 = loud without confirmation 4 = CPC Antenna support	
112	Confirmation mode for number 2 (ALARM)	1-6	1	5 = CPC Kone support 6 = P100 support If the ringback tone is detected and stops before the selected count of cycles is expired (parameter 954) in the Automatic dialling without confirmation mode (3), the call is considered successful.	
113	Confirmation mode for number 3 (ALARM)	1-6	1		
114	Confirmation mode for number 4 (ALARM)	1-6	1		
115	Confirmation mode for number 5 (ALARM)	1-6	1		
116	Confirmation mode for number 6 (ALARM)	1-6	1		
121	Confirmation mode for number 1 (button 2)	1-6	1		

Par. No.	Parameter name	Range of values	Default value	Note	Info
122	Confirmation mode for number 2 (button 2)	1-6	1		
123	Confirmation mode for number 3 (button 2)	1-6	1		
124	Confirmation mode for number 4 (button 2)	1-6	1		
125	Confirmation mode for number 5 (button 2)	1-6	1		
126	Confirmation mode for number 6 (button 2)	1-6	1		
171	Confirmation mode for number 1 (checking call)	1-6	2		
172	Confirmation mode for number 2 (checking call)	1-6	2		

Par. No.	Parameter name	Range of values	Default value	Note	Info
173	Confirmation mode for number 3 (checking call)	1-6	2		
174	Confirmation mode for number 4 (checking call)	1-6	2		
175	Confirmation mode for number 5 (checking call)	1-6	2		
176	Confirmation mode for number 6 (checking call)	1-6	2		
181	Confirmation mode for number 1 (operational call)	4-6	6	4 = CPC Antenna support 5 = CPC Kone support 6 = P100 support 7 = CPC Antenna 2N Ext support	
182	Confirmation mode for number 2 (operational call)	4-6	6	8 = CPC 2N Ext Kone support 9 = P100 2N Ext support	

Par. No.	Parameter name	Range of values	Default value	Note	Info
183	Confirmation mode for number 3 (operational call)	4-6	6		
184	Confirmation mode for number 4 (operational call)	4-6	6		
185	Confirmation mode for number 5 (operational call)	4-6	6		
186	Confirmation mode for number 6 (operational call)	4-6	6		
810	Time until the next checking call is activated.	hhmmss		Voice menu reads the value in the format of hours, minutes and seconds (hhmmss). It indicates when will be the next checking call activated.	From version 1.6.2
811	Manual activation of checking call	insert service password		<p>Having entered the service password, you can hear a short permanent tone (service received).</p> <p>The checking call is set up the moment programming is completed.</p> <p>Just press * for confirmation instead of entering the password in versions 2.0.9.0.17 and higher.</p>	From version 2.0.0

Par. No.	Parameter name	Range of values	Default value	Note	Info
850	User profile	1-9	1	Customer versions with pre-defined parameter values.	
890	Reset	insert service password		Lift1 is reset once the service password is entered and programming is completed. This does not affect the checking call timing. Just press * for confirmation instead of entering the password in versions 2.0.9.0.17 and higher.	
891	Switch password memory 1	up to 16 digits: 0-9	11	Passwords for switch activation during a call	
892	Switch password memory 2		empty		
893	Switch password memory 3		empty		
894	Switch password memory 4		empty		
895	Switch password memory 5		empty		
896	Switch password memory 6		empty		
897	Switch activation time	0-10 s	9 s	0 = switch is disabled	

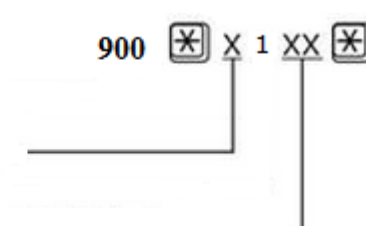
Par. No.	Parameter name	Range of values	Default value	Note	Info
900	Insert specific character in dial-in-prefix	<p>Entering format: 900 * X 1 XX *</p> <p>1 = * 2 = # 3 = space</p> <p>Character position, 01-16</p> <p>Note: The digits behind this position are shifted automatically.</p> 			
901	Dial-in prefix	up to 16 digits	empty	The dial-in prefix is included at the beginning of all the numbers dialled to a PSTN line.	From version 2.0.0
903	DTMF tone duration			Define the DTMF tone duration (ms). Each tone is followed by a pause of the same length.	From version 1.6.2
904	Dialling type	0-1	0	0 = tone 1 = pulse 40/60	From version 2.0.0 - parameter number change
911	Number of ringings until incoming call answering	1-99	2	Define the off-hook moment during ringing.	
912	Maximum call duration	0-990 s	120 s	0 = unfinished call Use the call-extending command (parameter 924) to extend the call.	1.4.0 - Range change

Par. No.	Parameter name	Range of values	Default value	Note	Info
913	Seizure timeout	10-990 s	60 s	Set the maximum period of time for the control centre staff to answer the call and send confirmation, otherwise 2N[®] Lift1 hangs up and dials the next number. Counted from the end of dialling.	
914	Delayed calling	0-100 s	0 s	Applied only if the CANCEL input is connected.	
916	CANCEL input inversion	0-1	0	0 = contact closed (or voltage present) at open door 1 = contact closed (or voltage present) at closed door	
917	Hang-up timeout between calls	5500-9999 ms	5500 ms		From version 2.0.0 - parameter number change
920	Alarm button mode	0-2	0	0 - Normally Open contact type 1 - Normally Close contact type 2 - Auto detection (autodetection is performed during upcoming boot of the product, the parameter value is changed to the type detected)	From version 2.0.0
921	Alarm button push signaling	0-1	0	The alert tone will be played when the button is pressed for the period of time set by parameter 962, ie before the alarm call is initiated 0 = OFF 1 = Alert tone 2 = Switch 3 = Alert tone + Switch	

Par. No.	Parameter name	Range of values	Default value	Note	Info
925	Button 2 mode	0-2	0	0 - Normally Open contact type 1 - Normally Close contact type 2 - Auto detection (autodetection is performed during upcoming boot of the product, the parameter value is changed to the type detected)	From version 2.0.6.0.13
933	Receiving volume (speaker)	0-22	16	22/25 = maximum volume (0 dB) 0 = minimum volume (-16 dB)	
934	Transmitting volume (microphone)	0-25	16		
935	Message volume	0-22	16		
941	Min. continuous tone time	200-9999 ms	7000 ms	If the tone is longer, 2N [®] Lift1 hangs up.	
942	Min. busy tone period	100-500 ms	100 ms	Use these parameters to adjust the busy tone detection.	
943	Max. busy tone period	100-2500 ms	1200ms		
944	Max. tone - space different of busy tone	10-400 ms	50 ms		
945	Min. count of busy tone periods	2-50	5		

Par. No.	Parameter name	Range of values	Default value	Note	Info
948	Min. ringback tone time	50-2000 ms	500 ms	For outgoing call detection: The ringback tone time is a time interval before the long gap. The longest ringing period gap must be in the interval between parameters 949 and 950.	
949	Min. ringback tone long space time	100-5000 ms	1000 ms		
950	Max. ringback tone long space time	500-9999 ms	5500 ms		
951	Min. ring tone time	50-2000 ms	500 ms	For incoming call detection: The ringtone time is the sum of sections between which there is no long gap. The longest ringing period gap must be in the interval between parameters 952 and 953.	
952	Min. ring tone long space time	100-5000 ms	1000 ms		
953	Max. ring tone long space time	500-9999 ms	6000 ms		
954	Count of ringing periods	1-99	10	Count of ringing periods for alarm /checking call. 2N[®] Lift1 hangs up after this count and dials the next number if Automatic dialling is enabled. Applied only in confirmation modes 1, 2, 3.	



Par. No.	Parameter name	Range of values	Default value	Note	Info
955	Ringling periods for checking calls	1-99	10		From version 1.6.2
961	Max. timeout for pressing the next digit	5-120 s	10 s	For password entering	
962	Min. time of pressing ALARM button	100-9999 ms	3000 ms	Applies to the ALARM button and button 2.	
963	Min. time of pressing button to trigger forced /test alarm	0-30s	0	Minimum time in seconds the alarm button needs to be pressed to activate the forced/test alarm. This alarm bypass the cancel contact status. 0 = disabled	From version 1.7.0.7.3
965	Privacy mode	0-24 hours	0	Privacy mode allows muting of the microphone on the 2N [®] Lift1. Possible setting of this parameter when the rescue mode is used are: 0 = Two way audio enabled only when the rescue mode is active. 1 - 24 = Two way audio enabled when the rescue mode is active and during a time window after a successful alarm call. After this time, the microphone on the unit is muted. 25 = Two way audio enabled always.	From version 2.0.0 - function change

Par. No.	Parameter name	Range of values	Default value	Note	Info
966	Rescue process	0-4	0	<p>0 = disable</p> <p>1 = end the rescue process by button 2</p> <p>2 = end the rescue process by password</p> <p>3 = end the rescue process by button 2 or rescue password</p>	From version 1.6.4
967	Disable /enable event after rescue process end	0-1	0	<p>0 = disabled</p> <p>1 = enabled</p> <p>After the rescue process end, a call is set up to the operational call memory number (081-086). The call should be routed primarily to the 2N[®] Lift8 server and automatically answered. This type of call is processed automatically via the CPC Antenna, CPC KONE or P100 protocol.</p>	From version 1.7.0

Par. No.	Parameter name	Range of values	Default value	Note	Info
968	Disable /enable EG battery error reporting	0-1	0	<p>0 = disabled</p> <p>1 = enabled</p> <p>2N® EasyGate transmits information on low or defective batteries to 2N® Lift1. 2N® Lift1 sets up a call to the operational call memory number (081-086). The call should be routed primarily to the 2N® Lift8 server and automatically answered. This type of call is processed automatically via the CPC Antenna, CPC KONE or P100 protocol.</p>	
969	ALARM button test	0-9999s	0	<p>0 = no test</p> <p>1-9999 = closing time after which a button is considered jammed</p> <p>If a button is evaluated as jammed, a call is set up to the operational call memory number (081-086). The call should be routed primarily to the 2N® Lift8 server and automatically answered. This type of call is processed automatically via the CPC Antenna, CPC KONE or P100 protocol.</p>	

Par. No.	Parameter name	Range of values	Default value	Note	Info
970	External gateway	0-1	0	Consumption from on-hook telephone line allowed	From version 2.0.0.0.5
871	Count of message repetitions	0-9	3	There is a 5-second space between two announcements.	From version 2.0.0 - parameter number change
872	Message recording	0-30 s	empty	User announcement recording function, can be used for lift identification.	From version 2.0.0 - parameter number change
974	Intercom identification number	up to 16 digits: 0-9	empty	Numeric lift identification	

Par. No.	Parameter name	Range of values	Default value	Note	Info
875	Message options	2 digits	55	<p>1st digit = message that is repeated after number dialling</p> <p>2nd digit = message that is played after connection confirmation and call end</p> <p>The meanings of the digits are as follows:</p> <p>1 = play user message recorded via parameter 872</p> <p>2 = read identification - parameter 974</p> <p>3 = combine options 1 + 2</p> <p>4 = send identification by DTMF</p> <p>5 = message as specified in parameter 877 (after confirmation according to parameter 876)</p> <p>6 = combine options 5 + 2</p> <p>7 = confirmation tone (after confirmation only)</p>	From version 2.0.0 - parameter number change

Par. No.	Parameter name	Range of values	Default value	Note	Info
876	Call confirmation and call end message language selection	0-9	1	<p>0 = 🎵</p> <p>1 = English</p> <p>2 = English</p> <p>3 = French</p> <p>4 = German</p> <p>5 = Spanish</p> <p>6 = Polish</p> <p>7 = Czech</p> <p>8 = Portuguese</p> <p>9 = Dutch</p> <p>10 = Slovak</p> <p>10 to 99 = silence</p> <p>Note:</p> <p><u>Refer to Subs. 4.2 for Message Overview.</u></p> <p> Caution! The order of the first two languages is inverse in the export versions: 1 = English, 2 = Czech!</p>	From version 2.0.0 - parameter number change
877	Outgoing call message selection	0-9	1	<p>10 to 99 = silence</p> <p>Note:</p> <p><u>Refer to Subs. 4.2 for Message Overview.</u></p> <p> Caution! The order of the first two languages is inverse in the export versions: 1 = English, 2 = Czech!</p>	
981	Checking call	0-6	0	<p>0 = disabled</p> <p>1 = enabled, first call in 3 minutes and then as set in parameter 983</p> <p>2 = enabled, first call in 2 hours and then as set in parameter 983</p> <p>3 = enabled, call as set in parameter 983</p> <p>4 = enabled, call on the nearest day set in parameter 986</p> <p>5 = enabled, first call in 3 minutes and then as set in parameter 986</p> <p>6 = enabled, first call in 3 minutes and then as set by the server during the call</p>	

Par. No.	Parameter name	Range of values	Default value	Note	Info
982	Check call interval	hhmmhhmm	00002359	Set announcements for lower traffic (lower tariff) time, generated at random in the set time interval.	
983	Check call period	0-100 days	3 days	0 = disabled (setting parameter 981 to 0 has the same effect), the value will be applied if parameter 981 is set to 1-6.	
984	Time setting	hhmm		Read the current time setting and set a new value if necessary.	
985	Data setting	RRMMDD		Read the current date setting and set a new value if necessary.	
986	Days of week for checking call	mtwtfss	0000000	<p>Values for Mon, Tue, Wed, Thu, Fri, Sat, Sun:</p> <p>0 = do not call 1 = call</p> <p>Example: 1000100 = the check call will be made on Mondays and Fridays.</p>	
987	LED signalling according to EN 81-28	0-1	1	<p>0 = disabled</p> <p>1 = enabled (Yellow LED permanently on during an Alarm Call, Yellow and green LED flashing alternately after an unsuccessful checking call)</p>	
991	Programming Menu password	up to 16 digits: 0-9	12345	Change the default programming password for access to the programming mode via a voice menu and for full initialisation.	

Par. No.	Parameter name	Range of values	Default value	Note	Info
992	Set the rescue termination password	up to 16 digits: 0-9	empty	Set the rescue terminating password.	
995	SW identification			Read the SW version. Writing is not allowed.	
996	User message deletion			Delete the user message recorded via parameter 872.	
997	Switch 1+2 password initialisation	insert service password		Set the default passwords (11) for switches 1. Re-enter the service password to avoid unintentional deletion of the 2N [®] Lift1 switch passwords.	
998	Dialling memory deletion for all buttons	insert service password		Delete all the memories (ALARM, button 2, check call memories). Re-enter the service password to avoid unintentional deletion of the 2N [®] Lift1 memories.	
999	Full initialisation (including service password)	insert service password		Set the 2N [®] Lift1 factory values. Re-enter the service password to avoid unintentional deletion of 2N [®] Lift1.	

i Note

- Independent of power supply, the used memory is capable of keeping data for 10 years at least unless 2N[®] Lift1 is damaged electrically.

3.3 2N[®] Lift1 Programming Tool

You can program 2N[®] Lift1 via a PC and the 2N[®] Lift1 Service Tool application. To connect the 2N[®] Lift1 audio unit, however, you need a special programming interface, 2N[®] Lift1 Programming Tool (Part No. 919680E). Connect the 2N[®] Lift1 Programming Tool to your PC via a USB A-B cable and to 2N[®] Lift1 via a special 10-wire cable. Connect the 10-wire cable to the audio unit board header, whose position is clearly marked on the audio unit back panel.

Caution

- The 2N[®] Lift1 Programming Tool is a crucial component allowing you to program 2N[®] Lift1 via a PC and 2N[®] Lift1 Service Tool.

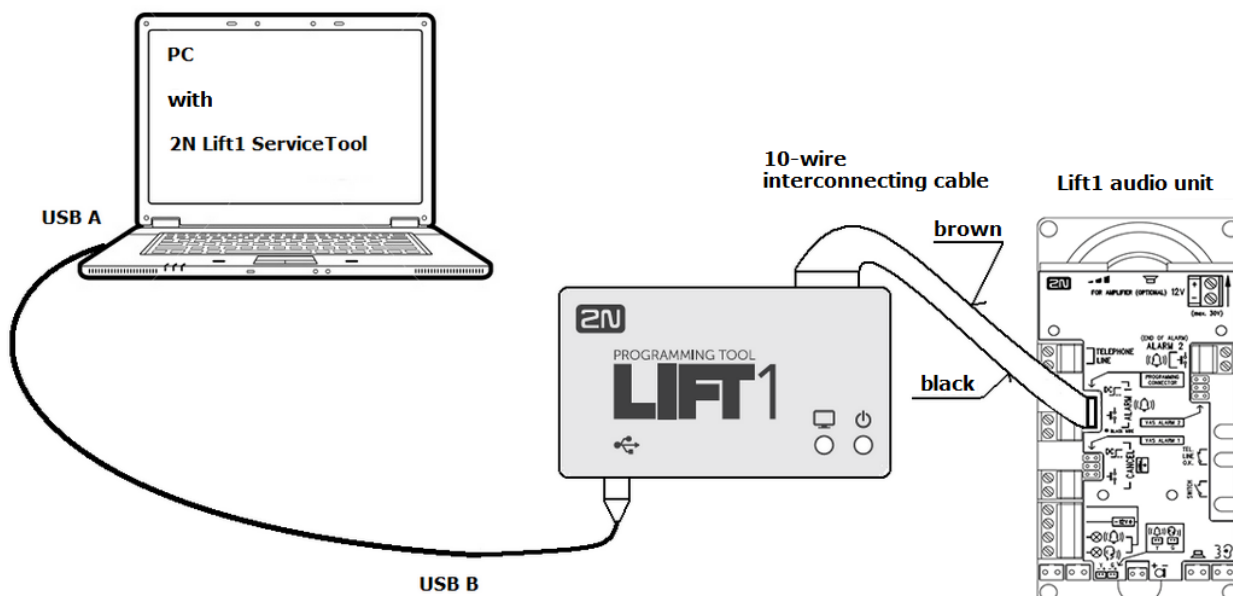

2N[®] Lift1 Programming Tool Connection

When the 2N[®] Lift1 Programming Tool is connected to a PC, the device is detected and the proper driver is installed. The 2N[®] Lift1 Programming Tool is then automatically assigned a COM port. View the COM port in the Connect to device menu in the 2N[®] Lift1 Service Tool. Refer to S. 5 for more 2N[®] Lift1 Service Tool details.

⚠ Warning

- Being programmed, 2N[®] Lift1 is powered from the USB port and need not be connected to a telephone line. Having been disconnected, however, 2N[®] Lift1 loses power and thus all unsaved data. (In case you need to configure time, connect a telephone line before disconnecting the programming tool.)

 **Note**

- To make your **2N[®] Lift1** remember time, leave the line connected during programming. Thus, no data will be lost after USB disconnection and the line will be detected as seized during programming.
- The programming interface provides galvanic isolation of the PC and **2N[®] Lift1**.
- The 10-wire interconnecting cable has no key on the **2N[®] Lift1** side, so respect the cable colours (see the figure). An inverse connection does not damage the device.
- Correct PC and **2N[®] Lift1** connections are indicated by the blue LED on the edge, which goes on and signals power supply.
- If the PC-**2N[®] Lift1** interconnecting program is running in **2N[®] Lift1**, the green LED starts shining. If not, mount the proper jumper (refer to 2.5 or 2.7 - Installation universal design / compact version) to switch **2N[®] Lift1** into the recovery mode.
- The green LED flashes to indicate programming.

 **Caution**

- Follow the instructions on the audio unit back side while connecting **2N[®] Lift1 Compact**.

3.4 SMS Configuration

You can set 2N[®] Lift1 using an SMS only if the device is connected to a telephone network via 2N[®] EasyGate PRO with special software. The software reads the configuration SMS message, seizes the line and sets parameters using the CPC protocol. If the command is OK, 2N[®] EasyGate PRO will send the processing information. If the command cannot be processed, an error response will be sent. SMS messages help you configure 2N[®] Lift1 easily without a PC. Let us describe their function here. You need to know the 2N[®] EasyGate PRO SIM card number to make SMS configuration work.

Warning

- This function cannot be used if the device is connected directly to a PSTN line!

Caution

- Make sure that every SMS to be sent to 2N[®] EasyGate PRO meets all the conditions listed below. Otherwise, the SMS will be ignored and no changes will be made.

Function Description

Make sure that all the parameters to be entered are correct. If an SMS parameter is incorrect, the SMS will not be processed and an error response will be sent.

Warning

Make sure that every configuration SMS includes the following parameters:

- Device name: L1
- Correct command format (CNF, DEF, SET or RST)
- Central Unit service password
- Correct parameter format (see the command parameters)
- Space separated parameters

Note

Maximum length of the command SMS message

- **2N[®] EasyGate does not support multipart messages.** A standard SMS can be up to 160 characters long according to the GSM standard, which permits a total of 1120 bits, i.e. 140 bytes, per SMS. As 7-bit encoding is used by default, 20 characters are saved in every 140 bytes. Therefore, 160 characters are the maximum SMS text length. GSM 03.38 is used as the character set. If non-ASCII characters (with diacritics) are used, 16-bit UCS-2 encoding is applied and the SMS contains 70 characters only. Information on all fragments of long SMS are written in the UDH (User Data Header) and so the maximum fragment length is 153 characters for 7-bit encoding. On principle, long SMS may consist of up to 255 fragments, but mobile devices support 6-8 fragments in practice.

Basic Configuration via CNF

You can set all the 2N[®] Lift1 CU parameters via a configuration SMS message. Every configuration SMS message must include the following parts: L1 header for 2N[®] Lift1's unique identification, CNF command for identification of the function to be performed, i.e. configuration in this case, and a valid service password, which is 12345 by default. Now you can enter the CU setting data in the parameter=value format. The SMS syntax is as follows:

```
<header> <CNF> <service password> <par1>=<val1> <par2>=<val2>
```

A complete SMS can be as follows, for example:

```
L1 CNF 12345 011=734523352 012=602874321 111=5 112=1
```

If everything is OK, you will receive the following confirmation SMS:

```
L1 CNF OK
```

Caution

- SMS-based configuration obeys the same rules and limitations as configuration via an application or a phone (maximum length, value range, digit limitation, etc.). If any of these rules is not met, 2N[®] Lift1 will set no parameters and send an error SMS specifying the wrong parameter.
- You can activate services 811, 890, 996, 997 and 998 via SMS in FW version 2.0.9.017 and higher.
- No service password confirmation is required for service execution, e.g. "L1 CNF 12345 811=".

Factory RESET

Use the DEF command to reset the CU factory values remotely. Once the command is received, the CU is factory reset immediately. The message syntax is as follows:

```
<header> <DEF> <service password>
```

A complete SMS can be as follows, for example:

```
L1 DEF 12345
```

If everything is OK, you will receive the following confirmation SMS:

```
L1 DEF OK
```

RESET Command

Use the RST command to restart **2N[®] Lift1** remotely. Once the command is received, the CU is restarted immediately together with the connected **2N[®] EasyGate PRO**. Upon restart, an SMS message is sent to confirm a successful process. The message syntax is as follows:

```
<header> <RST> <service password>
```

A complete SMS can be as follows, for example:

```
L1 RST 12345
```

If everything is OK, you will receive the following confirmation SMS:

```
L1 RST OK
```

Profile Changing Command

Profile configuration is customised in **2N[®] Lift1**. Use the SET command to set a selected profile and send a confirmation SMS. The message syntax is as follows:

```
<header> <SET> <service password> <profil number>
```

A complete SMS can be as follows, for example:

```
L1 SET 12345 4
```

If everything is OK, you will receive the following confirmation SMS:

```
L1 SET OK
```

Error Responses

If an error is detected in the configuration SMS or command processing procedure, 2N[®] Lift1 or 2N[®] EasyGate PRO will send an error response to you.

Caution

- If an error response was generated, the command was not executed!

The system sends error responses until all the configuration SMS parameters are correct and the command can be executed.

The following errors can be specified:

L1 ERR Invalid Message	The format of the received SMS is invalid. The L1 header is probably missing.
L1 ERR Unknown Command	An unknown command has been entered. The CNF, RST, DEF and SET commands are only allowed.
L1 ERR Invalid Syntax	There is a syntactic error in the SMS. Most probably, the password/command sequence, spacing and equal signs are wrong or there is a redundant text at the end.
L1 ERR Invalid Password	The Service password is absent or invalid.
L1 ERR Invalid Parameters	Some command parameters fail to match the CU parameters or the parameter value is beyond the allowed limits. For the CNF and SET commands only.
L1 ERR Does not Respond	<ul style="list-style-type: none"> • does not hook off within a 60s ringing timeout • hooks off but ignores the CPC programming transition command • hangs up during programming • ignores the WRITE_START, WRITE_CONFIRM or CRC_REQUEST command

Programming

Together with 2N[®] Lift1 configuration, you can also set some 2N[®] EasyGate PRO functions via an SMS message. Use the commands below to set the parameters that cannot be configured via a voice menu or to reset the gateway factory values. The command syntax is identical with 2N[®] Lift1, the only difference is the **EG** identifier. With a configuration SMS you can configure not only the voice menu parameters but also parameters 603 and 706, which contain a string and cannot be configured via the voice menu. Make sure that every configuration SMS includes the following parameters: EG header for 2N[®] EasyGate PRO's unique identification, CNF command for the function to be performed, i.e. configuration in this case, and a valid service password, which is 12345 by default. Now you can enter the CU setting data in the parameter=value format. Where a string is required (603, 706), enter the string in inverted commas ("(text)", see the example below. The SMS syntax is as follows:

```
<header> <CNF> <service password> <par1>=<val1> <par2>=<val2>
```

A complete SMS can be as follows, for example:

```
EG CNF 12345 101=10 603="(SMS from input)" 706="(internet.t-mobile.cz)"
```

If everything is OK, you will receive the following confirmation SMS:

```
EG CNF OK
```

Tip

- The bus or GSM/UMTS module may be restarted during SMS configuration, which indicates that new parameters have been set. The confirmation SMS is not sent until relogging in this case.

Factory Configuration Reset

Use the DEF command to reset the gateway factory configuration remotely. Once the command is received, the factory values are reset immediately. The message syntax is as follows:

```
<header> <DEF> <service password>
```

A complete SMS can be as follows, for example:

```
EG DEF 12345
```

If everything is OK, you will receive the following confirmation SMS:

```
EG DEF OK
```

RESET Command

Use the DEF command to restart the gateway remotely. Once the command is received, the gateway is restarted immediately. Upon restart, an SMS message is sent to confirm a successful process. The message syntax is as follows:

```
<header> <RST> <service password>
```

A complete SMS can be as follows, for example:

```
EG RST 12345
```

If everything is OK, you will receive the following confirmation SMS:

```
EG RST OK
```

Error Responses

Tip

- The error responses are completely identical with those for 2N[®] Lift1. The only difference is the **EG ERR** identifier.

4. Function and Use

This section describes the basic and advanced functions of the 2N[®] Lift1 product.

Here is what you can find in this section:

- 4.1 Function Description
- 4.2 Service and Operating Staff Instructions
- 4.3 Protocols CPC and P100

4.1 Function Description

Note

- The purpose of this section is to help technically trained persons get insight into the processes running in 2N[®] Lift1 during operation. This information is unnecessary for common 2N[®] Lift1 installations.

Outgoing Call

Press the ALARM button to activate 2N[®] Lift1. 2N[®] Lift1 seizes ("picks up") the line and sets up connection with the continuously working personnel or the control centre (refer to Automatic Dialling for details). During the call setup, the person in the lift can hear the dialtone, dialling, ringback tone and "Wait please, connection is being made" or any other announcement if available. The announcement can also include the 2N[®] Lift1 identifying data (address, lift number, etc.). When the operation staff receives the call, the parties can start speaking.

Check Call

A check call is an automatically made outgoing call whose purpose is to check the function of the 2N[®] Lift1 system. Unlike common outgoing calls, check calls have different announcements ("Check call") and use different phone number sets.

Typically, check calls are received automatically if the control centre is equipped with the 2N[®] Lift8 software. All you need to operate the program is a standard PC with a VoIP account.

Caution

- The control call can be manually initiated using parameter 811.

Incoming Call

The control centre can also call the **2N[®] Lift1** number. **2N[®] Lift1** automatically answers the line after two rings (or as configured) and sends a sound signal. The purpose is to provide the person trapped in the lift with necessary information (about rescue, for example) and check remotely whether **2N[®] Lift1** is connected and works properly.

Useless Startup Protection



As the only purpose of **2N[®] Lift1** is to call help in case of emergency, any call made when the door is open is considered useless. Hence, connect the door contact if available to the **2N[®] Lift1** CANCEL input and program a connection establishing delay after ALARM pressing. In this case, if the ALARM button is pressed by mistake, the lift arrives in the next floor and the door opens thus cancelling the call. Or, you can set the minimum button pressing time to prevent unintentional ALARM pressing.

1 and 2. Loud/Silent automatic Dialling of Multiple Numbers with Confirmation

Caution

- This is the default 2N[®] Lift1 mode that provides the most reliable connectivity. You can disable this mode or cancel confirmation, but the manufacturer shall not be liable for consequences if any in this case.

You can save up to 6 phone numbers and a defined count of redialling attempts for the **ALARM** button in the 2N[®] Lift1 memory. 2N[®] Lift1 then tries to call the listed numbers using tone dialling (DTMF) as the most reliable confirmation criterion. The dispatcher presses  on its phone (DTMF). If the called number is busy or unanswered within a timeout or for other reasons (see the table), 2N[®] Lift1 tries to call the next number(s) in the sequence until exhausting the defined count of cycles. If the count is 0, automatic dialling is disabled and 2N[®] Lift1 call one number only.

In this mode, 2N[®] Lift1 repeats the "Wait please" announcement (or any other user message) after redialling as many times as specified. Press  or  (call confirmation) to mute the announcement.

Evaluation of Loud Automatic Dialling with Confirmation

Situation	Response
Silence/busy tone after line pick-up	This situation does not affect the 2N [®] Lift1 operation. 2N [®] Lift1 makes dialling at any line state and only then evaluates the situation.
Busy tone (after dialling)	2N [®] Lift1 hangs up in approx. 2 seconds and dials the next number (can be changed by parameter 945).
Call or silence	2N [®] Lift1 waits for a preset time (login timeout), then hangs up and dials the next number.
Ringing tone	2N [®] Lift1 waits for a preset count of rings, then hangs up and dials the next number.
Continuous tone (on PBX line)	2N [®] Lift1 hangs up in approx. 10 seconds and dials the next number.
DTMF character 5 or #	2N [®] Lift1 hangs up immediately and dials the next number.
DTMF character 1	2N [®] Lift1 plays the "Connection confirmed" message (can be changed by parameter 975). The call takes the maximum preset time (Maximum call time).
2 3 4	These digits are interpreted as control characters (refer to Subs. 4.2. - Service and Operating Staff Instructions).

 **Caution**

- The PSTN connection quality does not allow for recognition of all the above listed situations. In addition, excessive noise in the lift cabin can adversely affect (decelerate) automatic dialling making it impossible to recognise the busy tone, for example. In general, DTMF is the most reliable confirmation signalling method as DTMF connection is always established (yet for a shorter time) even if 2N[®] Lift1 fails to recognise DTMF.



3. Loud Automatic Dialling of Multiple Numbers without Confirmation

This mode is useful where no trained personnel are available because the called person does not have to press any button. The two modes share a set of numbers, count of cycles, response to the busy tone, e.g., and so on. The difference is that the no-confirmation mode recognises the ringing tone and if the tone ends before the preset count of rings is exhausted, it means that the called user is off-hook and this is considered a successful connection.

 **Warning**

- Check the no-confirmation mode before use because ringing tones may be different in different countries/providers and may not be recognised correctly.

 **Note**

- In this mode, 2N[®] Lift1 does not repeat the "Wait please" announcement (or any other user message) after dialling because it would be impossible to recognise ringing reliably. The message is played once and shortly after the called user picks up the line. 2N[®] Lift1 cannot be controlled with the  to  buttons.

Evaluation of Loud Automatic Dialling without Confirmation

Situation	Response
Silence/busy tone after line pick-up	This situation does not affect the 2N [®] Lift1 operation. 2N [®] Lift1 makes dialling at any line state and only then evaluates the situation.
Busy tone	2N [®] Lift1 hangs up in approx. 2 seconds and dials the next number.
Call or silence	2N [®] Lift1 waits for a preset time (login timeout), then hangs up and dials the next number.
Continuous tone (on PBX line)	2N [®] Lift1 hangs up in approx. 2 seconds and dials the next number.
Ringing tone, which stops before 10 rings (configurable)	The call is considered successful, takes the maximum preset time (Maximum call time). The message is played once.
Ringing tone, which reaches 10 rings (configurable)	2N [®] Lift1 hangs up and dials the next number.
1 through 9, 0	These digits are interpreted as a beginning of the switch control password.
#	2N [®] Lift1 hangs up and dials the next number.

Warning

- Make sure before using this mode that no VoiceMail box, fax machine or any other device that could answer the call before the preset rings is installed on any of the numbers to be called to avoid automatic dialling termination.

4 and 5. CPC (Antenna and KONE)

Used wherever the counterparty is equipped with the required SW. When the line is answered, a DTMF string is sent and the lift is identified. The call is either switched to voice communication (alarm call) or confirmed automatically and terminated (check call), as the case may be.

6. P100

Used wherever the counterparty is equipped with the required SW. When the line is answered, a DTMF character is sent and the lift is identified. The call is either switched to voice communication (alarm call) or confirmed automatically and terminated (check call), as the case may be.

Call End (Outgoing/Incoming)

The call end (line hang-up) occurs whenever any of the below listed situations happens:

- The busy or continuous tone is detected (PBX call end).
- The maximum call time expires – 2N[®] Lift1 plays "Attention, the call is ending" 10 seconds before expiration for you to extend the call if necessary.
- The or character is received.
- The time limit expires during programming.
- The count of ringback tone periods exceeds the value set in parameter 954; the dialling attempt is terminated and calling continues according to the automatic dialling parameters.

Note

- The communicator is able to detect the continuous, busy and ringback tones even if the tone had two frequency components as in Great Britain, USA (BTT) and Canada.

Rescue Process

Use parameter 966 to activate the rescue process and define the way it shall be terminated (button 2/password/password and button 2). Then use parameter 967 to make 2N[®] Lift1 dial the number set in the error call memory (the 2N[®] Lift8 server is able to receive such calls via CPC Antenna, CPC KONE or P100) when the rescue process has been terminated.

- To keep the "Establishing connection" pictogram on, use external indication elements with autonomous power supply.
- The electronic board LED or external LED goes off, because 2N[®] Lift1 is line fed (enable the board LED light in parameter 970 – External gateway).
- Set the rescue password (parameter 992) and choose the function mode (parameters 966/968) to activate this function.
- Terminate the rescue process by pressing button 2 or typing the password during an incoming call. Type the rescue password as *password* (like with the switches).

Warning

- When parameter 970 is enabled (External gateway), the technician shall make sure that the line does not go into error in the on-hook state.

Caution

- Be sure to complete the operational call numbers (parameters 081-086) to set up operational calls successfully.
- When the rescue process is activated and parameter 966 is set to 1 or 3, you cannot use button 2 to set up an outgoing call to the number set in parameters 021-026 (the call can be set up after the rescue process is ended).

ALARM Button Test

Use parameter 969 to test the ALARM button for jamming (permanent pressing or sticking). The settings options lie in the range between 1 and 9999 seconds. 0 means disabled. If the button is pressed for the preset period of time, 2N[®] Lift1 detects a jammed button and sets up a call to the operational call memory number (2N[®] Lift8 server receives such calls via CPC Antenna, CPC KONE or P100).











Caution



- Be sure to complete the operational call numbers (parameters 081–086) to set up operational calls successfully.

4.2 Service and Operating Staff Instructions

DTMF Control during Call

Tone dialling can be used for 2N[®] Lift1 control during calls as shown in the table below if Automatic dialling with confirmation is enabled. Commands 1 to 5 are arranged conveniently for typical use.

DTMF character	Function
	Confirm to 2N [®] Lift1 that the call was successful. 2N [®] Lift1 mutes the currently played announcement and sends its confirmation signal. The call goes on until the call time limit is exhausted and any of the following commands can be used.
	Mute the voice module. CAUTION - this is unnecessary for calls with the new software version.
	Play the user message if stored in 2N [®] Lift1.
 or 	Call extension. The call is extended as defined in parameter 912 (120 seconds by default) upon this command. Can be used repeatedly.
 or 	Terminate the call.
	Play the serial number.



<p>  to  and  </p>	<p>These digits are interpreted as a beginning of the switch control password.</p> <ul style="list-style-type: none"> • Keep the *password* format.
--	---

The above table applies to Loud automatic dialling with confirmation.

 **Note**

- You cannot use the 2N[®] Lift1 microphone while the announcement is being played! Therefore, use function 1 or 2 to speak to the person in the lift.
- The above listed commands are sometimes **not received** in case they are sent during announcements when the connection is very poor. Therefore, 2N[®] Lift1 inserts a 3-second pause between the announcements to ensure reliable receiving of DTMF commands.

Switch Control

The switches if available can be used during outgoing and incoming calls. Activate the switch with a preset password in the following format:  password  of the maximum length of 16 digits. 2N[®] Lift1 confirms switch activation and closes the switch for a preset time (1 to 10 seconds) sending a tone signal (see the signalling table).

 **Tip**

- Use the switch for lift reset, for example. Control each switch with up to 6 passwords.

2N[®] Lift1 Signalling

2N[®] Lift1 uses various signals to communicate with the operating staff during programming. Refer to the table below for a list of these signals:

Signal	Name	Meaning
	Confirmation	The signal is sent to the line (for the calling user) when the incoming call is answered. Remote switch activation.
	Rejection	This signal is sent when a non-programmed button is pressed. When the communicator gets connected to the line, the connection signal is heard from the speaker. This tone is sent instead of confirmation in incoming calls to signal that 2N [®] Lift1 is not configured or memory data are corrupted.
	Saving	End of remote switch activation
	Hang-up	This signal is sent just before the call end (in all the cases).
Long continuous tone	Deletion	The tone is sent to signal dialling memory deletion, full initialisation and memory deletion before user message recording.
"Attention, the call is ending"		This announcement is sent during outgoing/incoming calls to signal that the maximum call time will expire in 10 seconds.
"Wait please ..."		Optional announcement during call setup
"Communicator number ... is calling"		Optional lift identifying announcement

Signal	Name	Meaning
Voice menu		In the programming mode

Announcements

The table below includes a list of language versions of standard announcements. Czech is the factory value. Use parameters 876 and 877 to change the language.

Parameter 876 value	Language selection Czech version	Call end announcement	Outgoing call announcement		
			Identification report if parameter 875 includes digit 2, 3 or 5	Connection confirming announcement if parameter 875 ends with digit 5	Check call identifying announcement
0	Tone signal		off	off	off
1	English	Attention, your call is being terminated	Communicator number..... is calling	Connection confirmed	Checking call
2	English	Attention, your call is being terminated	Communicator number..... is calling	Connection confirmed	Checking call
3	French	Attention, l'appel se termine	Connexion confirmée	Connexion confirmée	Appel de contrôle
4	German	Achtung, das Gespräch wird beendet	Es ruft das Notruftelefon Nummer.....an.	Verbindung bestätigt	Der Kontrollanruf
5	Spanish	Cuidado, la llamada termina		Conexión confirmada	Llamada de control
6	Polish				

7	Czech	Pozor, končí hovor	Volá komunikátor číslo	Spojení potvrzeno	Kontrolní volání
8	Portuguese	Outras chamadas estão à espera de ligação	Este é o comunicador	Conexão confirmada	Esta é uma chamada de controle
9	Dutch				
10	Slovak	Pozor, končí hovor	Volá komunikátor číslo		Kontrolné volanie

Parameter 877 value	Language selection - Czech version	Outgoing call announcement	Note
0	Tone signal	off	<ul style="list-style-type: none"> • This announcement is played if parameter 875 begins with digit 5. • The range of parameter 877 is 0 - 99. Additional announcements can be added to customer versions (more options and languages).
1	English	Wait please	
2	English	Wait please	
3	Slovak	Čakajte, prosím	
4	German	Warten Sie bitte	
5	Spanish		
6	Polish		
7	Czech	Čekejte, prosím	
8	Portuguese		
9	Dutch		
10	Slovak	Čakajte, prosím	

 **Caution**

- English has number 1 in the English version and West European languages can be selected.

2N[®] Lift1 Identification

If parameter 974 is set to any value and parameter 875 includes 2, 3 or 6, 2N[®] Lift1 identifies itself automatically with the "Communicator number ... is calling" announcement. Set the lift identification announcement using parameter 876.

4.3 Protocols CPC and P100

CPC

There are two CPC protocols: KONE and Antenna. These protocols can include 2N Ext, which completes the DATA (error) information with the shaft number and audio unit type.

The data message consists of:

Command - Call type - DATA - ID (974) - Axx (for 2N Ext only)

CPC KONE 2N Ext				
Call type	Command	Call type	Data	ID (974)
Alarm	04	10	00000000000000	parameter 974
Alarm 2	04	10	00000000000000	parameter 974
Checking call	04	21	00000000000000	parameter 974
Rescue process ended	04	84	00000000000000	parameter 974
Button stuck	04	90	00000000000000	parameter 974
Button repaired	04	90	00000000000001	parameter 974
Replace battery	04	31	15100700000000	parameter 974
Battery replaced	04	31	15100700000001	parameter 974

Note

This is only a part of the data message, excluding the beginning, checksum and end.

- 04900000000000000187654321 - Button repaired, identification number (parameter 974) 87654321

 **Caution**

- The Button repaired and Battery replaced information is only transmitted via the 2N Ext protocol.
- If the 2N Ext mode is not set, the operational call will not be established.

CPC Antenna 2N Ext				
Call type	Command	Call type	Data	ID (974)
Alarm	04	27	00000	parameter 974
Alarm 2	04	27	00000	parameter 974
Checking call	04	26	00000	parameter 974
Rescue process ended	04	84	00000	parameter 974
Button stuck	04	90	00000	parameter 974
Button repaired	04	90	00001	parameter 974
Replace battery	04	17	00000	parameter 974
Battery replaced	04	17	00001	parameter 974

 **Note**

This is only a part of the data message, excluding the beginning, checksum and end.

- 04900000087654321 - Button stuck, identification number (parameter 974) 87654321

 **Caution**

- The Button repaired and Battery replaced information is only transmitted via the 2N Ext protocol.
- If the 2N Ext mode is not set, the operational call will not be established.

P100

This protocol can also include 2N Ext, which completes the DATA (error) information with the shaft number and audio unit type.

The data message consists of:

Call type - ID (974) - DATA - Axx (for 2N Ext only)

P100			
Call type	Call type	ID (974)	DATA
Alarm	1	parameter 974	
Alarm 2	1	parameter 974	
Checking call	3	parameter 974	
Rescue process ended	2	parameter 974	500
Button stuck	2	parameter 974	800
Button repaired	2	parameter 974	801
Replace battery	2	parameter 974	100
Battery replaced	2	parameter 974	101

 **Note**

This is only a part of the data message, excluding the beginning, checksum and end.

- 287654321500 - Rescue process ended, identification number (parameter 974) 87654321

 **Caution**

- The Button repaired and Battery replaced information is only transmitted via the 2N Ext protocol.
- If the 2N Ext mode is not set, the operational call will not be established.

5. Service Tool

Here is what you can find in this section:

- 5.1 Installation and Login
- 5.2 Introduction to Application
- 5.3 Use

Refer to the 2N TELEKOMUNIKACE official websites, 2N[®] Lift1 download section, for the latest application versions.

5.1 Installation and Login

After the installation is launched, the installation program will scan your PC for another **2N[®] Lift1 Service Tool** version and ask you to uninstall the currently available version if identical with the new one. Use the system control panel Add or Remove programs to uninstall the existing product version for reinstallation or reconfiguration. If the versions are not identical, the original version will be uninstalled and a new application version will be installed. Then you will also be asked whether the configuration files should be retained or the application with an empty database should be installed.

Now the **2N[®] Lift1 Service Tool Setup Wizard** has been launched. Follow the wizard instructions. Select the **2N[®] Lift1 Service Tool** installation location: **C:\Program Files (x86)\2N TELEKOMUNIKACE\2N Lift1** is used by default. Also define whether the application shall be installed for the currently logged-in user, or all the PC users.

Now the wizard is ready to install the **2N[®] Lift1 Service Tool**. Confirm the user account administration notification to the Windows system if necessary. Another Start item and a desktop shortcut icon will be added automatically.

Tip

- The wizard will install the USB port driver if unavailable to identify the Central Unit connected.

Note

- The **2N[®] Lift1 Service Tool** installation requires **500 MB** of free disk space at least.

Now the **2N[®] Lift8 Service Tool** is ready for use. Click the shortcut item on the desktop (see the figure below) or select the Start item to start the application.



2N[®] Lift1 Service Tool Icon

After the application launch, the splashscreen gets displayed to inform you of the application manufacturer and current version. After the launch, you will see the basic screen and Configuration / Parameters menu. Here an offline table of parameters can be prepared for you to export the data. Click Connect device to get connected to the **CU** and move to the Connect to device menu. Select the **2N[®] Lift1** COM port and click Connect to get connected to the **2N[®] Lift1 CU**. The configuration table will be downloaded automatically.

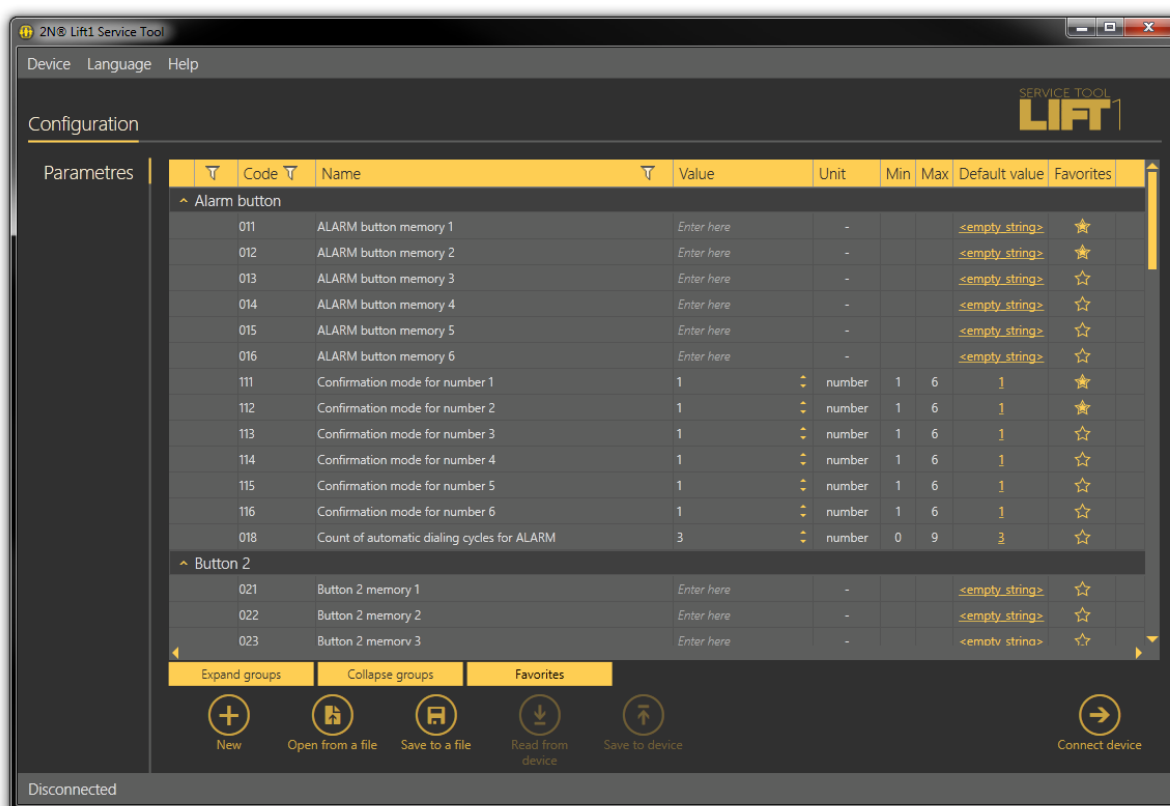

Application Window

 **Tip**

- The list of available COM ports only displays the ports to which the 2N[®] Lift1 programming level is connected.

 **Warning**

- Make sure that the USB port driver for 2N[®] Lift1 is properly installed on the logging-in PC. If not, the device will not be recognised and you will be unable to connect to it.
- If the Incompatible .NET version message is displayed upon the wizard launch, download the current .NETFX4.0 redistribution from the 2N TELEKOMUNIKACE websites or use the link [here](#).
- The minimum OS requirements are **Windows 8 / 8.1 CZ, Windows 7, Windows Vista**.

 **Note**

- **Recommended hardware requirements**

OS	Microsoft Windows 8 / 8.1 CZ, Microsoft Windows 7 SP1 CZ, Microsoft Windows Vista SP2 CZ
Other	Sound card (User sound record)

5.2 Introduction to Application

In this subsection, we will show you the application menu layout and basic controls. The application is divided into three menu levels. The first screen upon start includes Configuration / Parameter / Basic (see the figure below), which displays all of the three menu levels. The horizontal Main menu (Configuration) helps you select whether to configure the 2N[®] Lift1 system or record new voice menus. The vertical menus (Parameters) help you select the area to be administered. The third menu level, if meaningful, gets displayed horizontally to the right and includes a list of parameter setting forms.

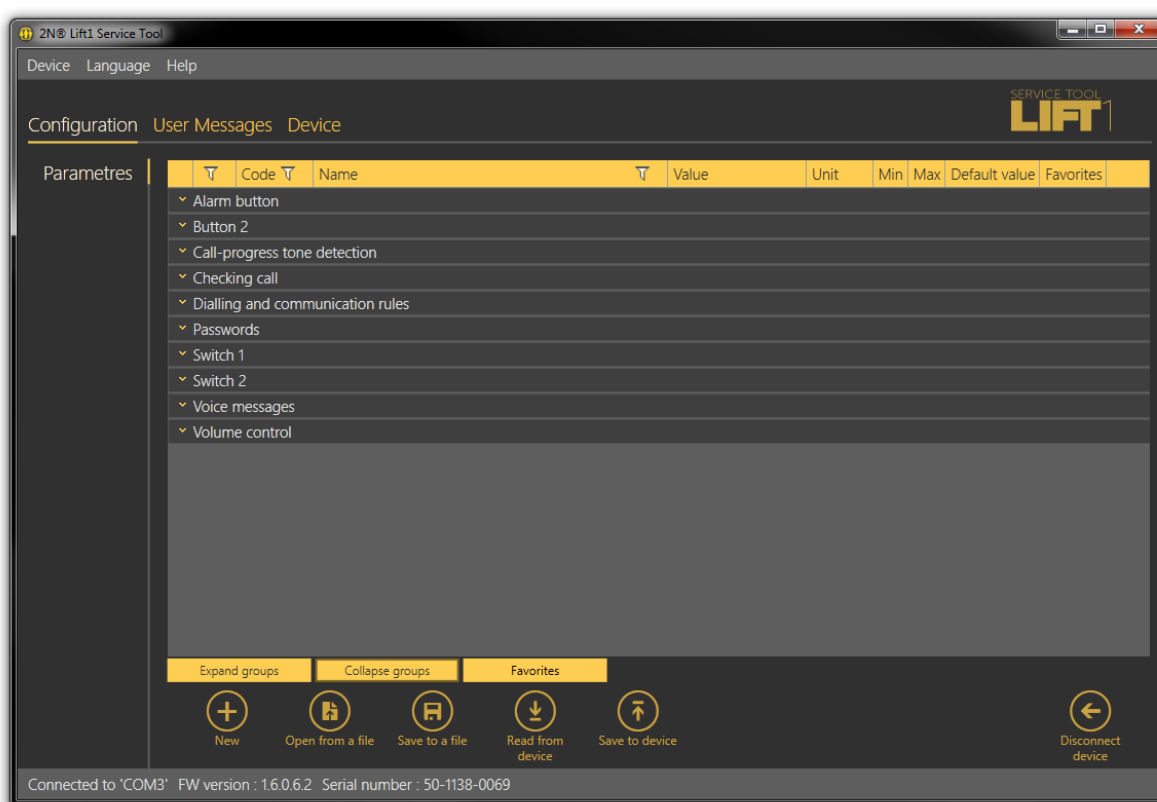

2N[®] Lift1 Service Tool Window

The main menu contains three pop-up menus. The Device menu helps you connect to or disconnect from the CU. Select the language mutation in the Language menu: CZ and EN are available so far. The Help menu provides a link to the latest manual version and information on the supplier. You will always be warned before logout or quit against potential data loss.







You will also be warned against data loss before loading a new configuration and overwriting the current set of parameters. Confirm your intention to avoid unintentional loss of unsaved parameters.





i Note

- The language change will not be executed until the application restart.

The Status line displays the following information, from the left: Connected to includes the name of the port to which you are currently connected corresponding with your PC COM port. FW version specifies the current **2N[®] Lift1** audio unit FW version and Serial number gives the **2N[®] Lift1** audio unit serial number. The logout button is situated in the right-hand bottom corner. The other controls in the lower part may be different in different menus. Let us describe all the buttons that are available in the application.

Basic Controls

 <p>New</p>	<p>New helps you create a new table of parameters. The existing table will be replaced after a warning.</p>
 <p>Open from a file</p>	<p>Open from file helps you read the table of parameters from a disk file.</p>
 <p>Save to a file</p>	<p>Save to file helps you save the current table of parameters into a disk file.</p>
 <p>Connect device</p>	<p>Connect device switches the user into the Connect to device menu.</p>
 <p>Back</p>	<p>Back returns you to the offline configuration menu.</p>
 <p>Connect</p>	<p>Connect connects the user to the port with the programming add-on.</p>

 <p>Read from device</p>	<p>Read from device downloads the current settings.</p>
 <p>Save to device</p>	<p>Save to device helps you save new parameters into the memory.</p>
 <p>Delete voice message in device</p>	<p>Delete voice message in device helps you delete a message saved in the device memory.</p>
 <p>Disconnect device</p>	<p>Disconnect device helps you log out from a device.</p>
 <p>Upgrade</p>	<p>Upgrade starts FW uploading to 2N[®] Lift1.</p>

5.3 Use

Upon the application launch, you get to the Configuration main menu and then the Parameters / Basic menu, where you can find almost all the 2N[®] Lift1 settings. You are in the offline configuration, which you can modify, prepare for download to a 2N[®] Lift1 audio unit or save into a file for later download. The offline mode helps you view the settings. The user has only access to the Configuration menu. The other menus are meaningful only if the audio unit is connected. The meaning and description of the parameters and controls are the same as in the online mode (i.e. with the CU connected); see below for details. Follow the CU login instructions in Subs. 5.1. Now let us explain what the menus are used for.

Configuration

Parameters

Having logged in to the CU as described in the preceding subsection, you get into the Configuration main menu. The Parameters / Basic menu includes the table of all the 2N[®] Lift1 parameters including their codes. Refer to **Subs. 3.2.** for the list of parameters and their meanings. All the parameters are arranged in associated groups for convenience. Moreover, each table row is equipped with a hint, which describes the parameter purpose and setting options. The table includes the following items: Code matches the parameter number in the voice menu, Name displays the parameter name, Value shows the currently set parameter value and Unit specifies the parameter unit (if no unit is specified in this column, the value is just a number). Maximum and Minimum define the permitted range of the values to be set. Default value displays the factory value of the parameter, which also appears after the factory reset. Click this value to add it to the Value column.

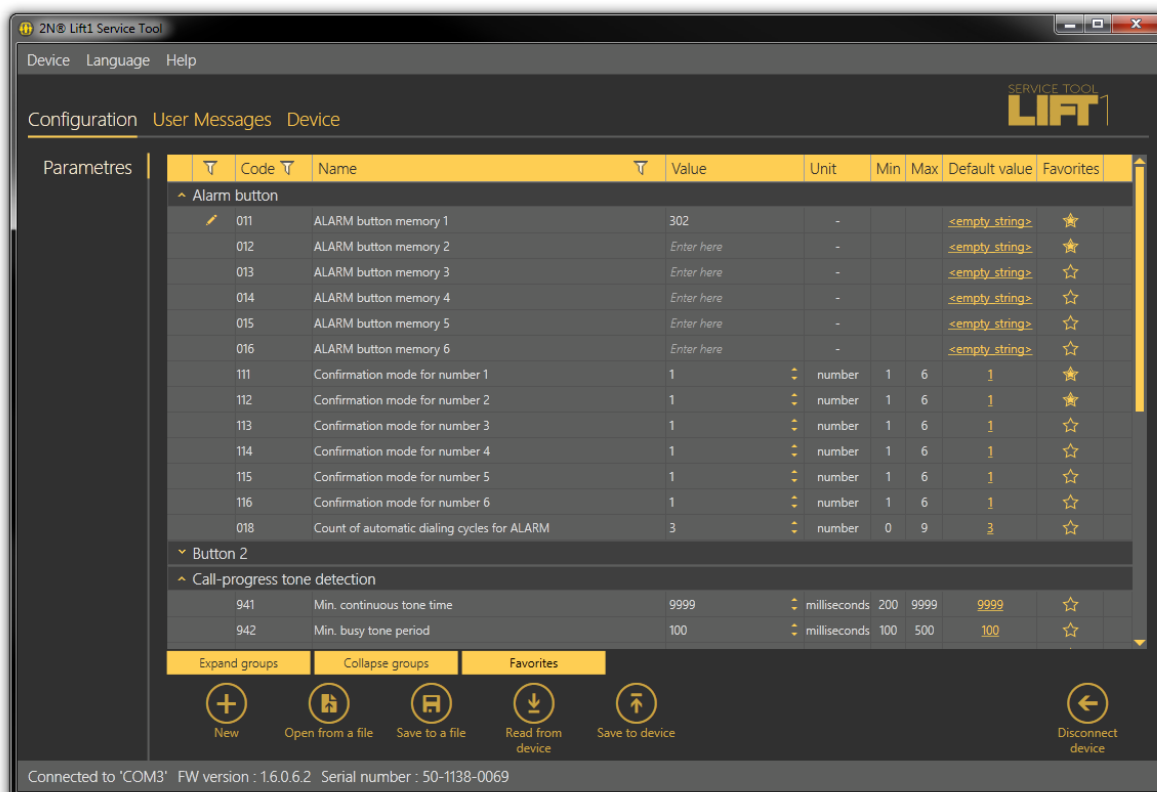

Configuration / Parameters Menu

The menu also includes the Expand groups / Collapse groups buttons for you to expand the sections and display all the required parameters quickly. Click the Favorites next to the Collapse groups button to display your favourite items in the table. Click on the empty star symbol behind a parameter in the Favorites column to select a new favourite item. Similarly, click on a filled-in star symbol to unselect a favourite item. Group expanding/collapsing and filtration are also useful for viewing favourite items. A yellow-to-orange colour change of the Favorites button means that the favourite items are only active. Click New set to overwrite the current settings with default values. Click Save to file to back up data into your PC disk. Push Open from file to read the back-up data. The Read from device button helps you read the current set of parameters from the CU. Finally, click Save to device to save the changes into the CU memory. Filtration is a convenient searching tool. Set the filter for each column separately and combine the filters to find the required data as quickly as possible. Click the funnel symbol in the selected column to activate the filter. Activation is indicated by a colour change of the funnel symbol; see the figure below.

	Code	Name	Value	Unit	Min
^ Call-progress tone detection					
	942	Min. busy tone period	100	milliseconds	100
	943	Max. busy tone period	800	milliseconds	100
	945	Min. count of busy tone periods	4	number	2

Left - Inactive Filter, Right - Active Filter

Each column with the funnel symbol includes own filter settings; see the figure below. The Contains function finds the searched string in all the column items and returns all the occurrences. Enter a text into the string field and click Filter to activate the filter and display all the searched items in the column. Use another filter in another column to make your search more precise and efficient. Having completed filtering, click Delete filter in the used columns or using the Alt+R keyboard shortcut to delete all the active filters. If you do not delete the setting, the filtration settings keep active even upon the 2N[®] Lift1 logout and you would obtain filtration results again instead of complete information in your next search.

	Code	Name	Value	Unit	Min	Max	Default value	Favorites
^ Call-progress tone detection								
	942	Min. busy tone period	Contains period				100	☆
	943	Max. busy tone period	Filter				800	☆
	945	Min. count of busy tone periods	4	number	2	50	4	☆
	954	Count of ringing periods	10	number	1	99	10	☆
^ Checking call								
	983	Checking call period	3	number	0	100	3	☆

Filtration Setting Result

 Tip

- Use the context menu opened by clicking anywhere in the table or the **Alt+R** keyboard shortcut to delete the set filters.
- Each table row is equipped with a hint including parameter description for convenience.

User Messages

User messages helps you replace the default system messages with messages of your own. Load the messages from a file or via the 2N[®] Lift1 Service Tool in the correct format. Use a microphone connected to your PC for recording.

Messages

The Messages menu displays the User message playlist including messages to be loaded into the device if necessary. When you enter the menu, the list is empty. Choose one of the following three adding options: click New to add a message to the list. The message is empty and you can replace it with a file of your own. Or, use the Read from device option to load the current voice message from the 2N[®] Lift1 audio unit connected. Or, click Load from directory to import a message saved on your disk. Select the folder with the message and confirm your selection. The selected voice message will be loaded to the application.

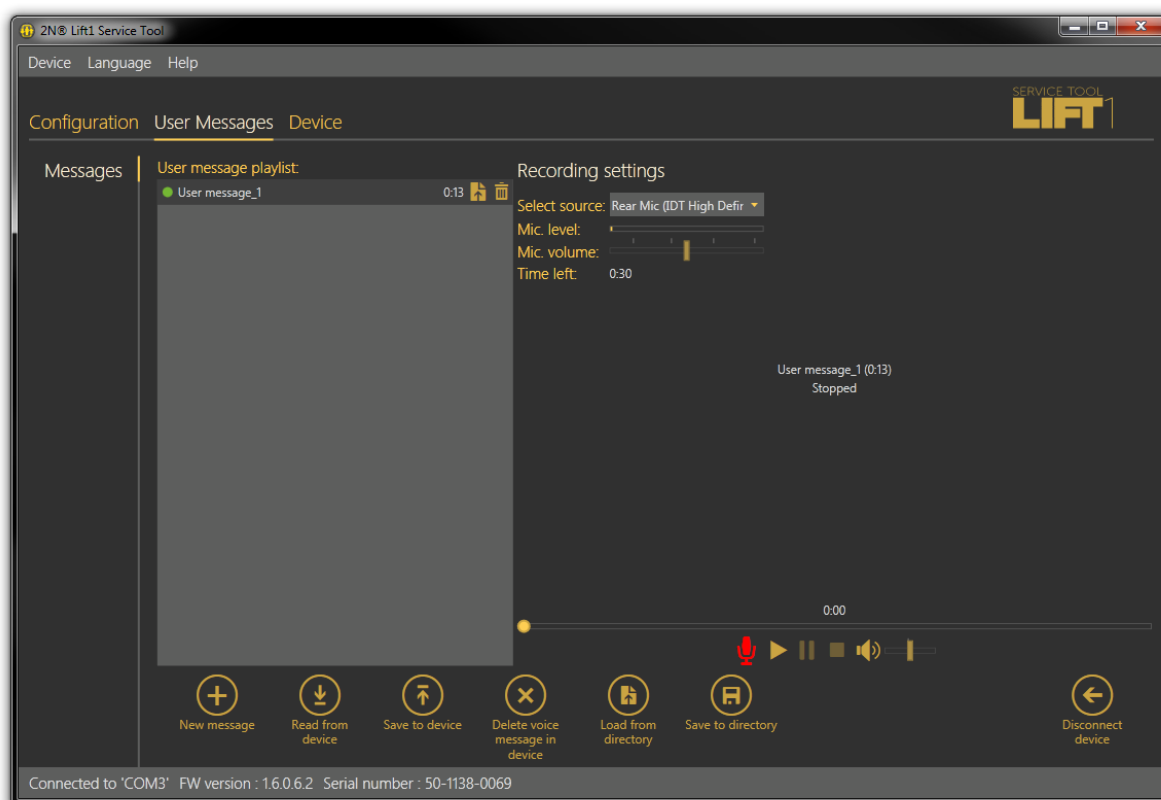

User Messages – Messages Menu

The User message playlist displays the message time and two buttons: Load message from file and Delete. If the message is not recorded, the total time is 0:00. Once you record a message, the total time will be displayed. Click this import button to open the disk file viewer for you to replace the message with another, correctly formatted file. If you just select a message, the message recorder will become available to the right for you to record a message. Standard recording functions are available: Play a message and select a Source. When the microphone icon goes red, start recording a new message while automatically deleting the preceding one.

Note

- The maximum message time is 30 s.
- The correct message format is .WAV. No other files can be imported.
- Do not record a message until you select the input source in the Recording settings.

The menu is faded while a new message is being recorded. The recorder displays the message name, total time and current state to signal active recording, play or stop. Click the Stop icon to stop recording. Click Play to check the currently recorded or imported voice message. Adjust the input source volume to slightly increase the volume of the message to be recorded, or use another source if the volume is still insufficient. Having completed editing, click Write to device to load the message into the **2N[®] Lift1** audio unit connected. Click Save to directory to save the current file onto your PC disk. To delete a message, select the message and click on the Trash icon.

Caution

- The application output volume setting does not affect the master volume of the voice message recorded. If the record volume is too low, repeat recording with a higher volume level.

Tip

- Use high-quality microphones and noise controlled rooms with good acoustic properties for recording only to avoid poor recording quality and interference.

Recording Settings

The Recording settings in the left-hand upper corner of the screen helps you select the input source and control the microphone volume. Select an item in the source list: integrated/external microphone or line input. Set the Mic. level and Mic. volume for the input source. The total time for a message to be imported to **2N[®] Lift1** is 30 seconds. Refer to the Time left parameter for the remaining message editing time.

Note

- If the microphone input is overexcited during recording, turn the Mic. volume down. If the message is too quiet, turn the volume up.
- In case the volume setting is not sufficient, use the system drivers or an external amplifier.

Device

The Device menu provides information on the 2N[®] Lift1 audio unit connected: basic parameters and, last but not least, firmware, bootloader and voice menu upgrading options.

Info

The Info menu provides basic information on the state of the device connected: audio unit firmware version, serial number and voice menu language and version, for example. The Time in device parameter displays the current time read from the 2N[®] Lift1 audio unit. This parameter is not read online and has to be updated using the Read from device button. Set time in device helps you record a time setting of your own. Click on the calendar to set the date/time in hours manually. You can overwrite the setting and set a different time value for a different time zone. Click Confirm to confirm the new setting. Click Save current time from PC to device to synchronise the audio unit time with your PC time value and load the new setting into the audio unit automatically.

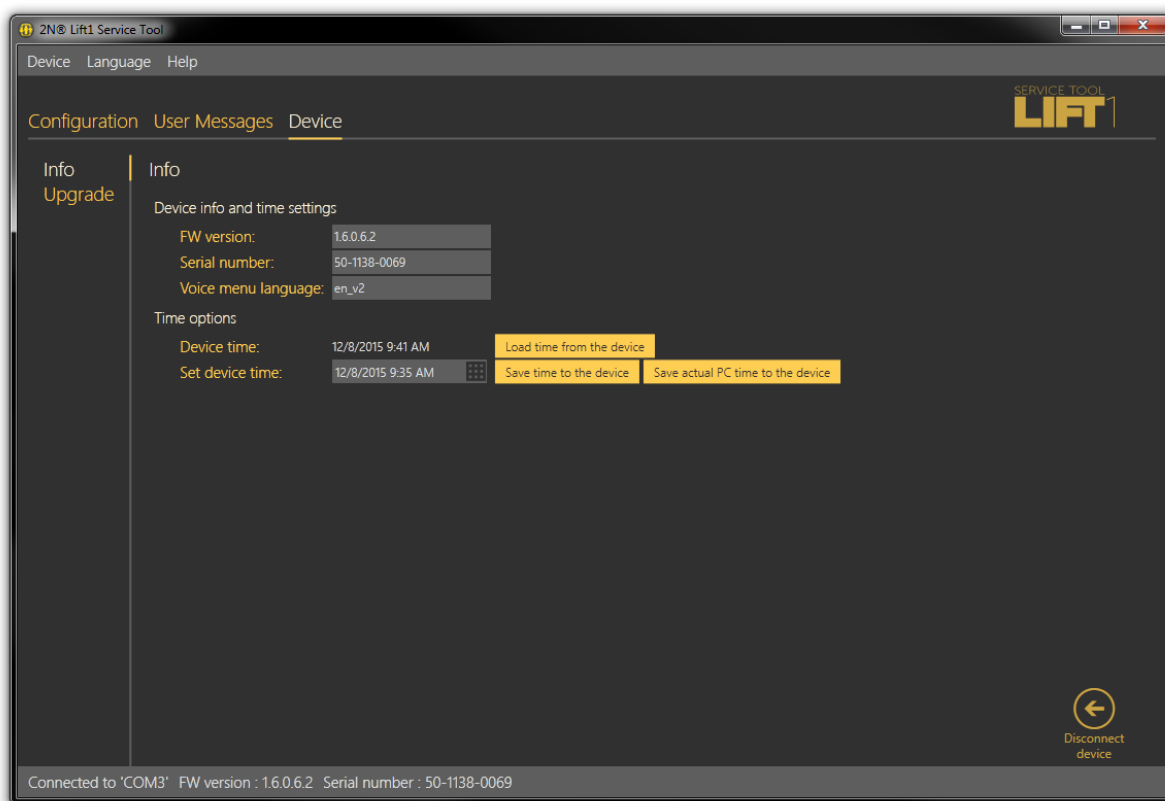

Device / Info Menu

Note

- As the 2N[®] Lift1 time is not backed up, the time setting will be lost in the case of power outage.

Upgrade

The Upgrade menu helps you upgrade the firmware, bootloader and voice menu. Select the file to be loaded in the File name section for the program to automatically read the type from the file header and display it as the file type: Firmware, Bootloader or Voice menu. Click Select to select a file and press Upgrade to make 2N[®] Lift1 Service Tool upload the new Firmware, Bootloader or Voice menu version into the audio unit.

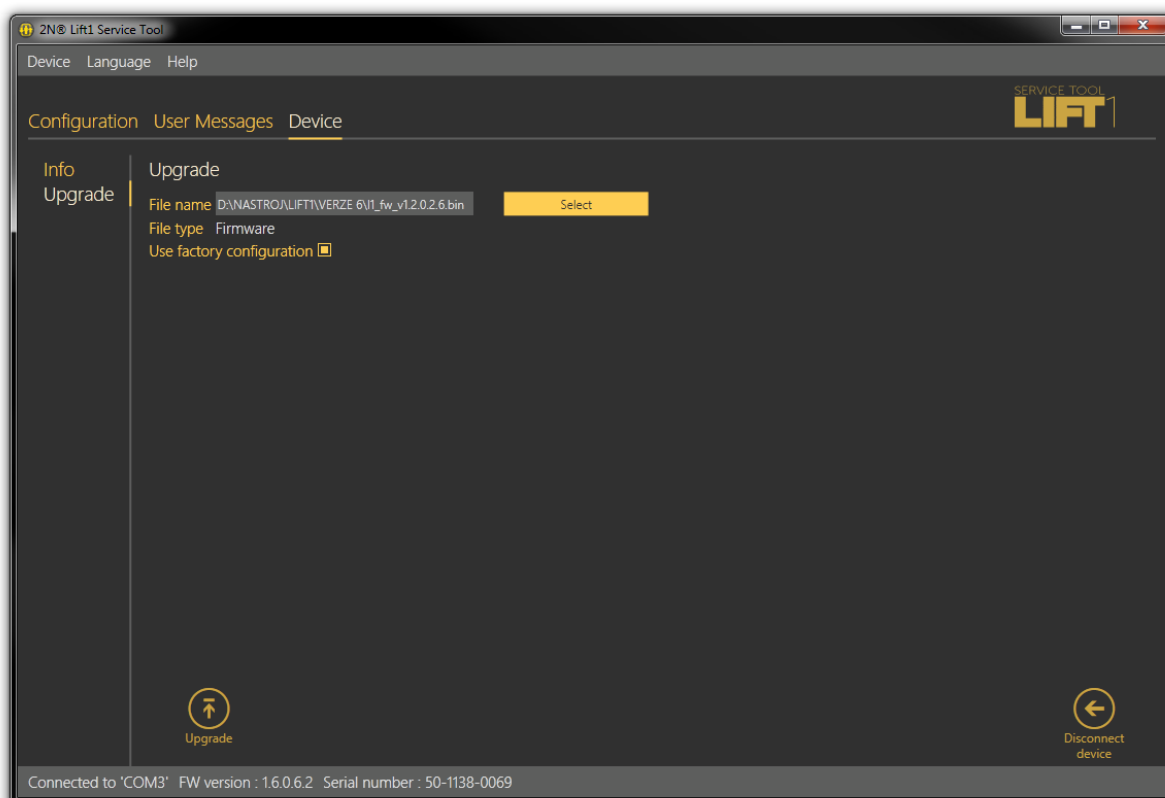

Device / Upgrade Menu

Activate the Use factory configuration checkbox to delete all user-changed values and use factory configuration. Select this option and click Upgrade to reset the factory values upon upgrade. This action is always accompanied by loading of a new FW, Bootloader or voice menu version to the audio unit. To set the default values only, use the Configuration menu.

Caution

- After the firmware, bootloader or voice menu upgrade, the audio unit will be restarted automatically and the application will be disconnected. Reconnection will not be possible until the audio unit has executed upgrade and restart.

6. Technical Parameters

Electric Parameters

Parameter	Value	Conditions
Minimum line current	15 mA	off-hook
Minimum line voltage	22 V	on-hook
Off-hook DC voltage drop	< 9 V < 12 V	I = 20 mA I = 50 mA
On-hook resistance	>1 M Ω	U = 25..100 V
Off-hook impedance	220 Ω + 820 Ω paral. 115 nF	15 to 60 mA
Return loss	> 14 dB	15 to 60 mA
Bandwidth	300 to 3500 Hz	15 to 60 mA
Ringing impedance	> 2 k Ω C = 0.47 μ F	25 to 50 Hz
Ringing detector sensitivity	10 to 20 V	25 to 50 Hz
Pulse dialling	40 / 60 ms	
DTMF dialling level	-9.0 +2.0/-2.5 dB and -11.0 dB +2.5/-2.0 dB	15 to 60 mA
Overvoltage protection - between A, B	1000 V	8 / 20 μ s

Notes:

1) Any ringing course is accepted.

Switch Parameters

- **Minimum voltage:** 9 V AC / DC
- **Maximum voltage:** 24 V AC / DC
- **Maximum current:** 1 A AC / DC
- **Resistance - open:** min. 400 k Ω
- **Resistance - closed:** approx. 0.5 Ω
- **Fuse:** resettable

Connection of External Indicators

- **Supply voltage:** 12–24 V DC, external power supply
- **Maximum switched current:** 200 mA

Other Parameters

- **Universal model dimensions:** 65 x 130 x 24 mm
- **Compact model dimensions:** 100 x 185 x 16 mm
- **Working temperature range:** -20 to +70 °C

7. Supplementary Information

This section provides supplementary information on the 2N[®] Lift1 product.

Here is what you can find in this section:

- 7.1 Troubleshooting
- 7.2 List of Terms and Abbreviations
- 7.3 Directives, Laws and Regulations
- 7.4 General Instructions and Cautions

7.1 Troubleshooting



For the most frequently asked questions refer to faq.2n.cz.

Have you forgotten your service password? Contact our Technical Support and communicate your **2N[®] Lift1** serial number.

7.2 List of Terms and Abbreviations

- Incoming call - call in the control centre - 2N[®] Lift1 direction
- Outgoing call - call in the 2N[®] Lift1 - control centre direction
- Check(ing) call - automatically activated call in the 2N[®] Lift1 - control centre direction
- Control centre - workplace receiving alarm/check calls and failure reports. There can also be separate workplaces for various call types or just the staff mobile telephones.
- L8 - 2N[®] Lift8 system, the software can control the check/alarm calls and fully administer the 2N[®] Lift1 communicators and other similar devices if necessary
- PBX - private branch exchange (equipped with analogue local lines and, typically, PSTN connection)
- PSTN - public switched telephone network. It is considered for simplification that 2N[®] Lift1 is connected to the PSTN although it works along a PBX line in the same way.

7.3 Directives, Laws and Regulations

2N[®] Lift1 conforms to the following directives and regulations:

2014/35/EU on the harmonisation of the laws of the Member States relating to the making available on the market of electrical equipment designed for use within certain voltage limits

2014/30/EU on the harmonisation of the laws of the Member States relating to electromagnetic compatibility

2011/65/EU on the restriction of the use of certain hazardous substances in electrical and electronic equipment

2012/19/EU on waste electrical and electronic equipment

7.4 General Instructions and Cautions

Please read this User Manual carefully before using the product. Follow all instructions and recommendations included herein.

Any use of the product that is in contradiction with the instructions provided herein may result in malfunction, damage or destruction of the product.

The manufacturer shall not be liable and responsible for any damage incurred as a result of a use of the product other than that included herein, namely undue application and disobedience of the recommendations and warnings in contradiction herewith.

Any use or connection of the product other than those included herein shall be considered undue and the manufacturer shall not be liable for any consequences arisen as a result of such misconduct.

Moreover, the manufacturer shall not be liable for any damage or destruction of the product incurred as a result of misplacement, incompetent installation and/or undue operation and use of the product in contradiction herewith.

The manufacturer assumes no responsibility for any malfunction, damage or destruction of the product caused by incompetent replacement of parts or due to the use of reproduction parts or components.

The manufacturer shall not be liable and responsible for any loss or damage incurred as a result of a natural disaster or any other unfavourable natural condition.

The manufacturer shall not be held liable for any damage of the product arising during the shipping thereof.

The manufacturer shall not make any warrant with regard to data loss or damage.

The manufacturer shall not be liable and responsible for any direct or indirect damage incurred as a result of a use of the product in contradiction herewith or a failure of the product due to a use in contradiction herewith.

All applicable legal regulations concerning the product installation and use as well as provisions of technical standards on electric installations have to be obeyed. The manufacturer shall not be liable and responsible for damage or destruction of the product or damage incurred by the consumer in case the product is used and handled contrary to the said regulations and provisions.

The consumer shall, at its own expense, obtain software protection of the product. The manufacturer shall not be held liable and responsible for any damage incurred as a result of the use of deficient or substandard security software.

The consumer shall, without delay, change the access password for the product after installation. The manufacturer shall not be held liable or responsible for any damage incurred by the consumer in connection with the use of the original password.

The manufacturer also assumes no responsibility for additional costs incurred by the consumer as a result of making calls using a line with an increased tariff.

Electric Waste and Used Battery Pack Handling



Do not place used electric devices and battery packs into municipal waste containers. An undue disposal thereof might impair the environment!

Deliver your expired electric appliances and battery packs removed from them to dedicated dumpsites or containers or give them back to the dealer or manufacturer for environmental-friendly disposal. The dealer or manufacturer shall take the product back free of charge and without requiring another purchase. Make sure that the devices to be disposed of are complete.

Do not throw battery packs into fire. Battery packs may not be taken into parts or short-circuited either.



An Axis company

2N TELEKOMUNIKACE a.s.

Modřanská 621, 143 01 Prague 4, Czech Republic

Phone: +420 261 301 500, Fax: +420 261 301 599

E-mail: sales@2n.cz

Web: www.2n.cz

v2.0.2