



2N[®] Helios IP Video Kit

IP Intercom Module



Installation Manual

Version 2.4

www.2n.cz

The 2N TELEKOMUNIKACE a.s. is a Czech manufacturer and supplier of telecommunications equipment.



The product family developed by 2N TELEKOMUNIKACE a.s. includes GSM gateways, private branch exchanges (PBX), and door and lift communicators. 2N TELEKOMUNIKACE a.s. has been ranked among the Czech top companies for years and represented a symbol of stability and prosperity on the telecommunications market for almost two decades. At present, we export our products into over 120 countries worldwide and have exclusive distributors on all continents.



2N[®] is a registered trademark of 2N TELEKOMUNIKACE a.s. Any product and/or other names mentioned herein are registered trademarks and/or trademarks or brands protected by law.



2N TELEKOMUNIKACE a.s. administers the FAQ database to help you quickly find information and to answer your questions about 2N products and services. On www.faq.2n.cz you can find information regarding products adjustment and instructions for optimum use and procedures „What to do if...“.



2N TELEKOMUNIKACE a.s. hereby declares that the 2N[®] Helios IP Video Kit product complies with all basic requirements and other relevant provisions of the 1999/5/EC directive. For the full wording of the Declaration of Conformity see the CD-ROM (if enclosed) or our website at www.2n.cz.



The 2N TELEKOMUNIKACE a.s. is the holder of the ISO 9001:2009 certificate. All development, production and distribution processes of the company are managed by this standard and guarantee a high quality, technical level and professional aspect of all our products.

Content

| | |
|--|-----------|
| 1. Product Overview | 4 |
| 1.1 Components and Associated Products | 6 |
| 1.2 Terms and Symbols | 12 |
| 2. Description and Installation | 13 |
| 2.1 Before You Start | 14 |
| 2.2 Mechanical Installation | 15 |
| 2.3 Electric Installation | 18 |
| 2.5 Configuration | 26 |
| 2.4 Extending Module Connection | 28 |
| 3. Technical Parameters | 31 |
| 4. Supplementary Information | 34 |
| 4.1 Troubleshooting | 35 |
| 4.2 Directives, Laws and Regulations | 36 |
| 4.3 General Instructions and Cautions | 37 |

1. Product Overview

Here is what you can find in this section:

- [1.1 Components and Associated Products](#)
- [1.2 Terms and Symbols](#)

Basic Features

2N® Helios IP Video Kit is a universal and reliable IP intercom module designed for integration in the third parties' equipment. It is provided with a number of useful functions that are not quite common in the devices of this category. Featuring the SIP standard support and compatibility with renowned IP exchange and telephone manufacturers, **2N® Helios IP Video Kit** can make use of all VoIP services available on the market.

2N® Helios IP Video Kit is equipped with two composite video inputs, and can support two analog cameras with PAL or NTSC standard. The intercom transcodes the analog signal to video stream in selected format, such as H.264, H.264, MJPEG etc.

2N® Helios IP Video Kit is equipped with a 10W power amplifier for external loudspeaker connection. If the power output of the internal loudspeaker is insufficient for your specific application, you can connect an external loudspeaker to the line output. You can also connect an external electret microphone or another audio signal source to the IP intercom line output.

2N® Helios IP Video Kit allows up to 16 separate buttons or a 16-button matrix keypad to be connected. Set the button function flexibly according to your specific application needs. You can set up to three telephone numbers and call time profiles to each of the buttons to make the called subscriber accessible any time. Configure the buttons as a numerical keypad, which can be used as a switch activation code lock or for dialling a preset or any other telephone number.

2N® Helios IP Video Kit is equipped with one relay output and two active 12 V outputs. Use the numerical keypad or, during the call, any telephone to control these outputs. A wide range of output mode settings help you make use of a high number of applications.

2N® Helios IP Video Kit is equipped with two galvanically isolated digital inputs and three status signalling outputs.

2N® Helios IP Video Kit is very easy to install. All you have to do is connect it to your LAN using the LAN cable. An integrated two-port LAN switch simplifies installation on sites with a limited LAN infrastructure. Supply the intercom either from a 9–36 V source or directly from your POE supporting LAN.

Use a PC web browser to configure your **2N® Helios IP Video Kit** . Apply the **IP Manager** to administer extensive intercom installations easily and quickly.

Advantages of Use



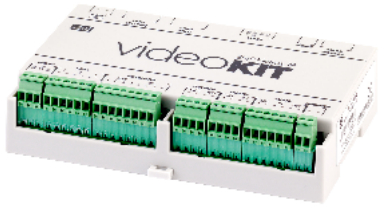
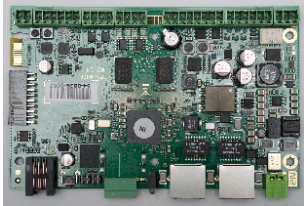

- Industrial design and variable mounting options
- Wide supply power range + PoE supply
- Two analog cameras connection
- Integrated 10 W power amplifier
- External amplifier connection
- External microphone/audio signal source connection
- Galvanically isolated relay output
- Two controlled active 12 V outputs
- Two galvanically isolated logic inputs
- Up to 3 signalling LED outputs
- Up to 16 external buttons/matrix keypad connection
- Integrated two-port LAN switch
- Bidirectional communication – acoustic echo cancelling
- Configuration via web interface/special PC application
- SIP 2.0 support
- Video codecs (H.263, H.263+, H.264, MPEG-4, MJPEG)
- Audio codecs (G.711, G.729, G.722, L16/16kHz)
- HTTP(S) server for configuration
- SNTP client for server time synchronisation
- RTSP server for audio streaming
- TFTP client for automatic configuration and firmware update

1.1 Components and Associated Products

Basic Units

| | |
|---|---|
|  A white plastic box labeled 'videokit' containing an intercom module. The box has two rows of green terminal blocks on the front. |  A green printed circuit board (PCB) populated with various electronic components, including integrated circuits, capacitors, and connectors. It is the intercom module without its packaging. |
| <p>Part No. 9154100C Intercom module in plastic box</p> | <p>Part No. 9154101C Intercom module without box</p> |



Internal Units

| | | |
|--|--|---|
|  |  | |
| <p>Part No. 91378365</p> <p>2N® Indoor Touch - black</p> <p>The elegant internal touch panel, 2N® Indoor Touch, is suitable for all 2N® Helios IP intercoms. On the panel's display not only can you find out who is at the door, but also start a conversation with the visitor, open the lock or turn on the light in the entrance hall.</p> | <p>Part No. 91378365WH</p> <p>2N® Indoor Touch - white</p> <p>The elegant internal touch panel, 2N® Indoor Touch, is suitable for all 2N® Helios IP intercoms. On the panel's display not only can you find out who is at the door, but also start a conversation with the visitor, open the lock or turn on the light in the entrance hall.</p> | |
|  |  |  |
| <p>Part No. 91378366</p> <p>2N® Indoor Touch - black</p> <p>WiFi</p> <p>The elegant internal touch panel, 2N® Indoor Touch, is suitable for all 2N® Helios IP intercoms. On the panel's display not only can you find out who is at the door, but also start a conversation with the visitor, open the lock or turn on the light in the entrance hall.</p> | <p>Part No. 91378367</p> <p>2N® Indoor Touch - black</p> <p>WiFi + NFC</p> <p>The elegant internal touch panel, 2N® Indoor Touch, is suitable for all 2N® Helios IP intercoms. On the panel's display not only can you find out who is at the door, but also start a conversation with the visitor, open the lock or turn on the light in the entrance hall.</p> | <p>Part No. 91378368</p> <p>2N® Indoor Touch - black</p> <p>NFC</p> <p>The elegant internal touch panel, 2N® Indoor Touch, is suitable for all 2N® Helios IP intercoms. On the panel's display not only can you find out who is at the door, but also start a conversation with the visitor, open the lock or turn on the light in the entrance hall.</p> |

VoIP Telephones

| | |
|--|---|
|  |  |
| <p>Part No. 91378357 Grandstream GXV3240 VoIP video telephone</p> <p>GXV3240 is the successor to the popular GXV3140 model, which allows comfortable video calls in the IP network. Touchscreen and keyboard control.</p> | <p>Part No. 91378358 Grandstream GXV3275 VoIP telephone</p> <p>GXV3275 is the successor to the popular GXV3175 model, which allows comfortable video calls in the IP network. Touchscreen control.</p> |

Electric Locks

| | | |
|--|---|--|
|  |  |  |
| <p>Part No. 932071E BEFO 11211</p> <p>12V/230mA DC</p> <p>low consumption</p> | <p>Part No. 932081E BEFO 11221 with momentum pin</p> <p>12V/230mA DC</p> <p>low consumption</p> <p>For opening of the lock a short electrical impuls is sufficient, which unlocks the lock. Lock is then open until someone closes the door.</p> | <p>Part No. 932091E BEFO 11211MB with mechanical blocking</p> <p>12V/230mA DC</p> <p>low consumption</p> <p>Enables mechanically close or open the lock. When opened, the lock is open all the time. When closed, it behaves as standart electrical lock.</p> |







Tip





- FAQ: [Electric locks - Difference between locks in 2N® Helios IP accesories](#)

Power Supply

| | | |
|---|--|--|
|  |  |  |
| <p>Part. No. 91378100 PoE injector - without cable</p> <p>Part. No. 91378100E PoE injector - with EU cable</p> <p>Part. No. 91378100US PoE injector - with US cable</p> <p>For power supply of intercom via ethernet cable when PoE switch is not available.</p> | <p>Part No. 91341481E Stabilised 12 V / 2 A power supply needs to be used when no PoE is available.</p> | <p>Part No. 932928 12 V transformer</p> <p>For external power supply of the lock with 12V AC voltage.</p> |

Additional Modules

| | | |
|---|---|---|
|  |  |  |
| <p>Part No. 9159010</p> <p>Security Relay</p> <p>A handy add-on that significantly enhances door entry security as it prevents tampering with the intercom and forced opening of the lock. To be installed between intercom and lock, powered by the intercom.</p> | <p>Part No. 9137410E</p> <p>External IP Relay - 1 output</p> <p>Standalone IP device which can be controlled by HTTP commands sent by Helios IP intercom, which can thus control devices on unlimited distance.</p> | <p>Part No. 9137411E</p> <p>External IP Relay - 4 outputs, PoE</p> <p>Standalone IP device which can be controlled by HTTP commands sent by Helios IP intercom, which can thus control devices on unlimited distance.</p> |
|  |  |  |
| <p>Part No. 9159013</p> <p>Exit button</p> <p>A button for connection to a logic input for opening a door inside a building.</p> | <p>Part No. 9159012</p> <p>Magnetic door contact</p> <p>Set for installation on a door, enabling the status of door opening to be ascertained. Used when the intercom is used for door protection, to detect when the door is not closed or forced open.</p> | <p>Part No. 9159014EU/US/UK</p> <p>2N® 2Wire</p> <p>(set of 2 adaptors and power source for EU/US/UK)</p> <p>The 2N® 2Wire converter allows you to use existing wiring (2 wires) from your original door bell or door intercom to connect any IP device. You don't have to configure anything, and you only need one 2N® 2Wire unit at each end of the cable and a power source connected to at least one of these units. The 2N® 2Wire unit then provides PoE power not only to the second converter, but also to all other connected IP end devices.</p> |

| | | |
|---|---|---|
|  |  |  |
| <p>Part No. 9154001</p> <p>Electret microphone with self-adhesive layer.</p> <p>Sensitivity 42dB, operating temperature 5-35°C. Adhesion surface 25x25 mm. Must be protected from water penetration.</p> | <p>Part No. 9154002</p> <p>Speaker with self-adhesive layer.</p> <p>External dimensions 60x60 mm, actual speaker diameter 45 mm. Must be protected from water penetration.</p> | <p>Part No. 9154003</p> <p>Analogue camera for connection to the OEM intercom 2N® Helios IP Video Kit</p> |
|  | | |
| <p>Part No. 9154004</p> <p>Water-proof metal button</p> | | |

✔ **Tip**

- For more accessories and particular advice please contact your local distributor of 2N products.

1.2 Terms and Symbols

The following symbols and pictograms are used in the manual:

 **Safety**

- **Always abide** by this information to prevent persons from injury.

 **Warning**

- **Always abide** by this information to prevent damage to the device.

 **Caution**

- **Important information** for system functionality.

 **Tip**

- **Useful information** for quick and efficient functionality.

 **Note**

- Routines or advice for efficient use of the device.

2. Description and Installation

Here is what you can find in this section:

- [2.1 Before You Start](#)
- [2.2 Mechanical Installation](#)
- [2.3 Electric Installation](#)
- [2.4 Extending Module Connection](#)
- [2.5 Configuration](#)

2.1 Before You Start

Product Completeness Check

Before installing this product, please check whether the **2N[®] Helios IP Video Kit** delivery complies with the following packing list.

- 1× **2N[®] Helios IP Video Kit**
- 1× Short Installation Manual

2.2 Mechanical Installation

Mounting Types

Refer to the table below for a list of mounting types and necessary components. Make sure that the installation site is not exposed to flowing or condensed water.

Wall mounting

Use the proper wall mounting screws and dowels (not included in the delivery). Hang the device on the wall using the cover bottom holes.

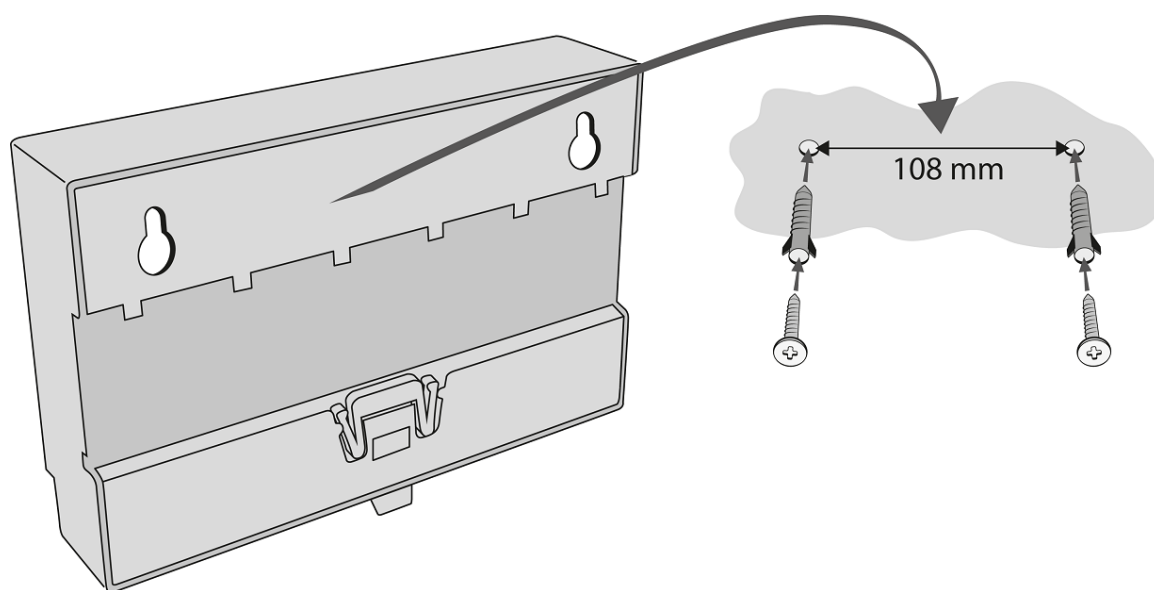

DIN rail mounting

Mount the device to a standard TS 35 DIN rail. The recommended minimum DIN rail length is 14 cm.

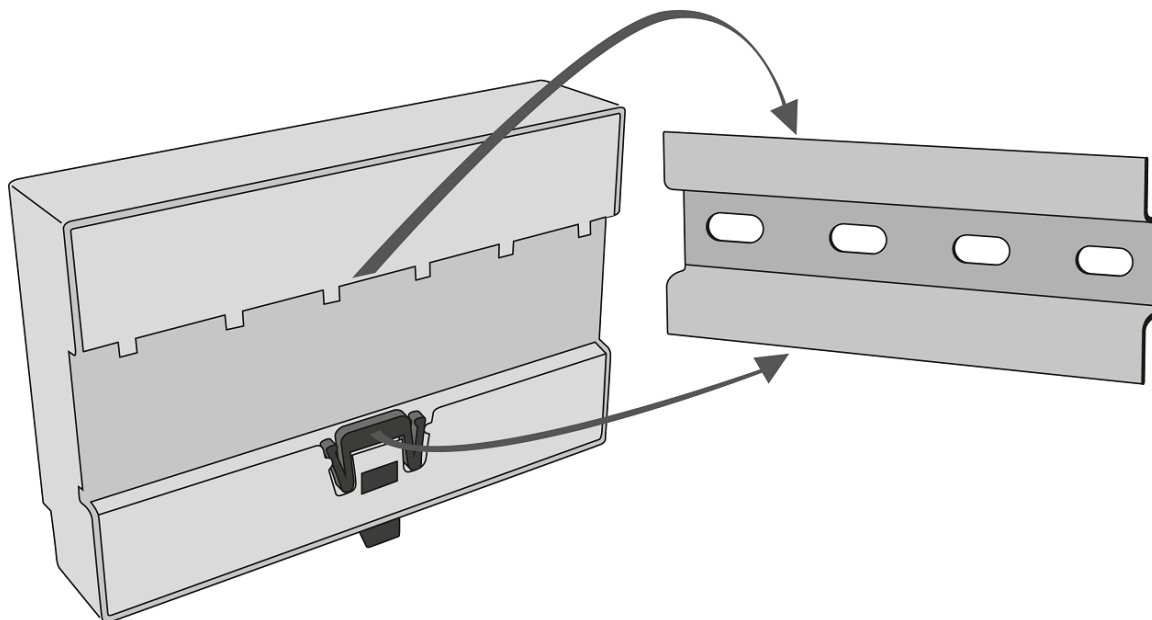

PCB mounting (for Part No. 9154101 only)

Use 4–6 distance columns and proper screws (not included in the delivery) to mount the PCB to the support. Fix the distance columns as shown in the figure.

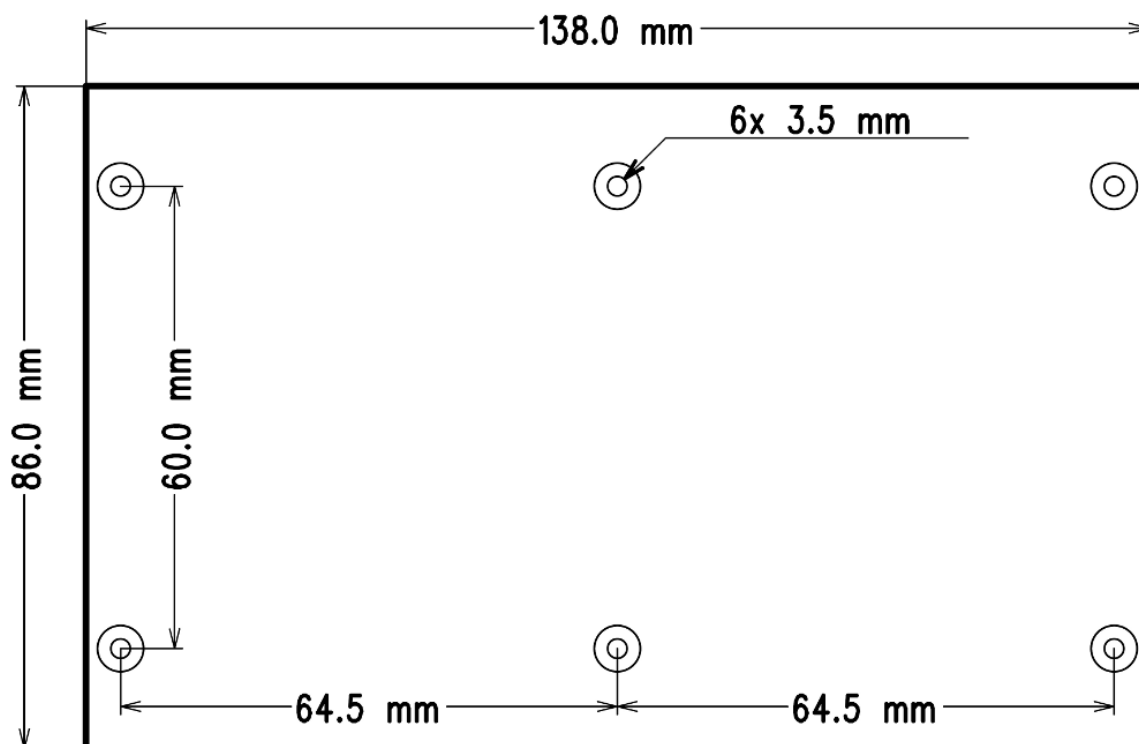

⚠ Caution

- The warranty does not apply to the product defects and failures arisen as a result of improper mounting (in contradiction herewith). The manufacturer is neither liable for damage caused by theft within an area that is accessible after the attached electric lock is switched. The product is not designed as a burglar protection device except when used in combination with a standard lock, which has the security function.
- When the proper mounting instructions are not met, water might get in and destroy the electronics. It is because the intercom circuits are under continuous voltage and water infiltration causes an electro-chemical reaction. The manufacturer's warranty shall be void for products damaged in this way!

2.3 Electric Installation

Device and PCB Connectors

Figures below show the layout of the **2N[®] Helios IP Video Kit** connectors and terminals.

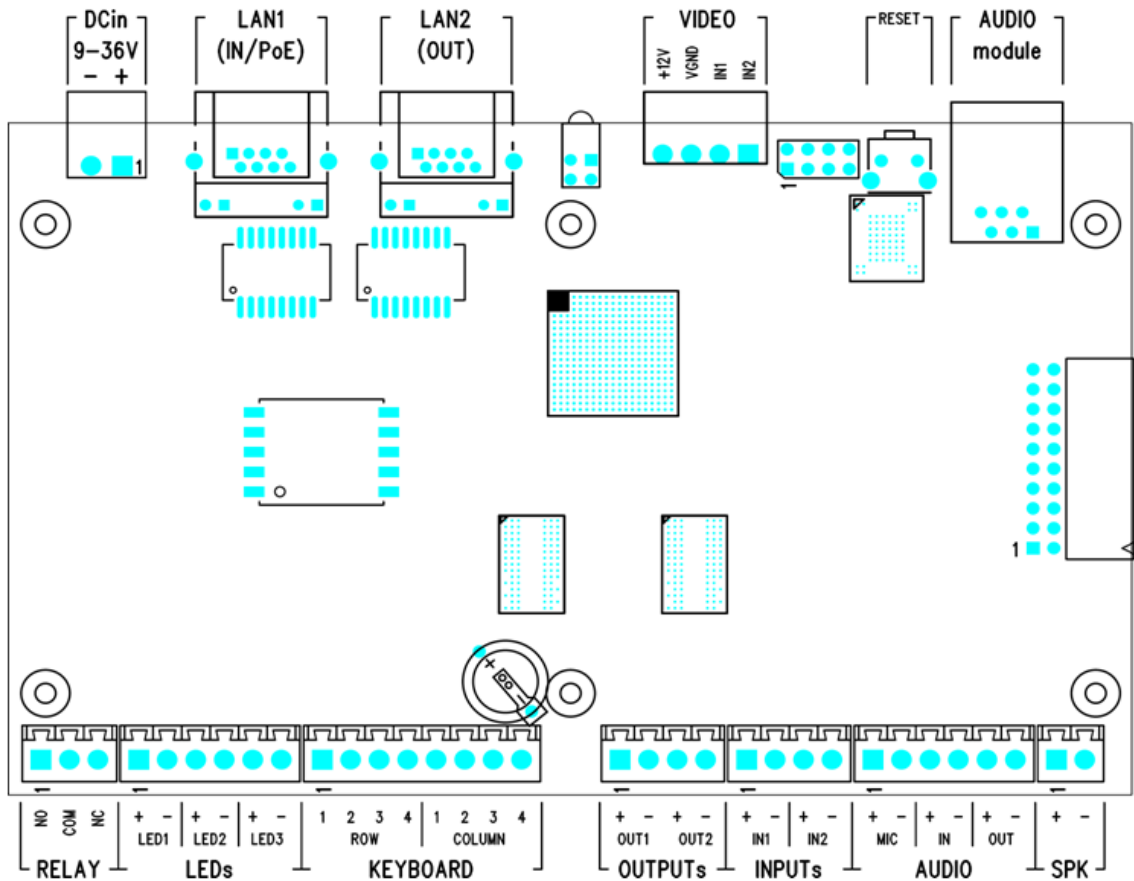

Figure: PCB Connectors

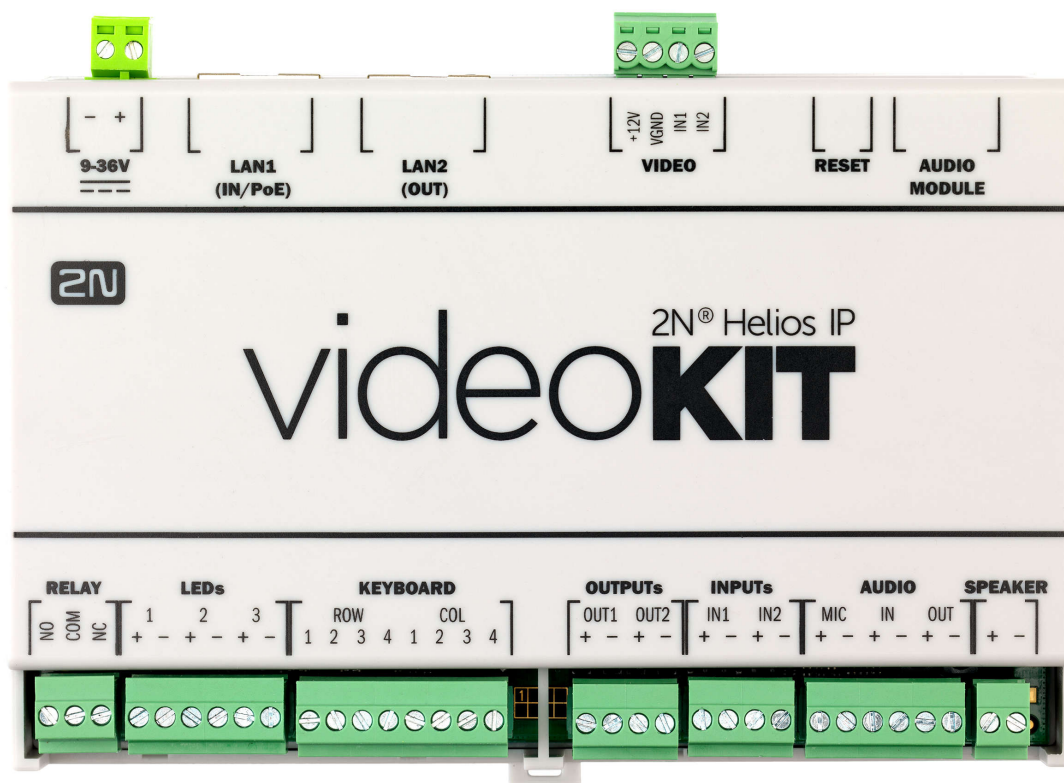

Figure: Connectors

| Group | Terminals | Function |
|--------------|--------------------------------------|--|
| DC in | | 9–36 V / 1.5 A power input |
| LAN1 | | LAN connection with PoE function |
| LAN2 | | LAN connection |
| D1 | | Integrated red and green LED indicators |
| VIDEO | +12 V, VGND, IN1, IN2 | Connection of up to two analog cameras connected via composite PAL or NTSC signal |
| RESET | | RESET multifunction button |
| AUDIO MODULE | | Connection of an audio module with microphone, loudspeaker, buttons and LEDs |
| RELAY | NO, COM, NC | Programmable relay switch with an accessible N/O and N/C contact |
| LEDs | LED1+, LED1– LED2+, LED2– | 3 current outputs for connection of programmable LED indicators; two terminals per LED |
| KEYBOARD | COL1–4 ROW1–4 | Connection of matrix keypad (4×4) or 16 separate buttons |
| OUTPUTS | OUT1+, OUT1– OUT2+, OUT2– | 2 programmable active 12 V DC/ 650 mA outputs |
| INPUTs | IN1+, IN1– IN2+, IN2– | 2 programmable galvanically isolated inputs |
| AUDIO | MIC+, MIC– IN+, IN– OUT+, OUT– | Microphone input, line input, line output |
| SPEAKER | SPK+ SPK– | Power amplifier output for loudspeaker |

Connection to LAN

Connect **2N® Helios IP Video Kit** to the LAN using an RJ-45 terminated UTP/STP cable (of category Cat 5e or higher). As the device is equipped with the Auto-MDIX function, you can use either the straight or crossed cable version.

2N® Helios IP Video Kit is equipped with two LAN interfaces (LAN1 and LAN2) and an integrated Ethernet switch. You can use only LAN1 interfaces for LAN connection. LAN1 is the only interface provided with PoE. LAN2 helps connect another LAN device on the installation site. This interface is not equipped with PoE.

Note

- **2N® Helios IP Video Kit** does not allow you to feed another connected device via PoE. The integrated PoE function is intended for the **2N® Helios IP Video Kit** supply only.

Connection of External Power Supply

2N® Helios IP Video Kit can be supplied either from an external 9–36 V / 2 A DC source or directly from the LAN provided with the PoE 802.3af supporting network elements.

External Power Supply

Connect the external 12V power supply to the DC in terminals. Use safety low-voltage voltage (SELV, 9–36 V) dimensioned for the minimum current consumption of 1.5 A (Part No. 91341481E, e.g.) to make your device work correctly.

PoE Supply

2N® Helios IP Video Kit is compatible with the PoE 802.3af technology (Class 0 – 12.95 W) and can be supplied directly from the LAN via compatible network elements. If your LAN lacks such compatible elements, you can insert a PoE injector, Part No. 91758100E, between your **2N® Helios IP Video Kit** and the nearest network element. Connect your **2N® Helios IP Video Kit** to the LAN via the LAN1 interface to supply it successfully.

Caution

- In case you feed your **2N® Helios IP Video Kit** via PoE or from a limited-power external power supply, monitor the power consumption of the whole system. With regard to the PoE 802.3af capacities and efficiency of the switched-mode power supplies in the device, the maximum possible device input is approximately 12 W. An overload of the PoE source usually results in PoE disconnection and, subsequently, **2N® Helios IP Video Kit** restart.
- The **2N® Helios IP Video Kit** consumption at relax (power amplifier inactive, no load switched on LED1–3 and OUT1–2 outputs) is up to 2 W.
- The maximum power amplifier consumption is determined by the current loudspeaker volume level and impedance (up to 10 W for a 4 Ω loudspeaker). The real consumption is typically lower and depends on the characteristics of the signal to be amplified.
- If you intend to connect a considerable load to the OUT1 and OUT2 outputs, make sure that the total input does not exceed the above mentioned limit (12 W for PoE). If the PoE supply fails to provide sufficient power for the specific application, use a more powerful external source to make your device work perfectly.

Connection of LED Indicators

2N® Helios IP Video Kit is equipped with three independent current LED control outputs (LED1+, LED2+ and LED3± terminals). All of them are current outputs (20 mA, up to 12 V). You can connect the LEDs directly to the terminals of these outputs or use LEDs with serial resistors. Mind the polarity while connecting the LEDs to make your device work properly.

The functions of the LED1, LED2 and LED3 outputs are programmable.

Connection of Keypad/Buttons

2N® Helios IP Video Kit is equipped with an interface for connection of an external matrix keypad or up to 16 separate buttons; see the figure below:

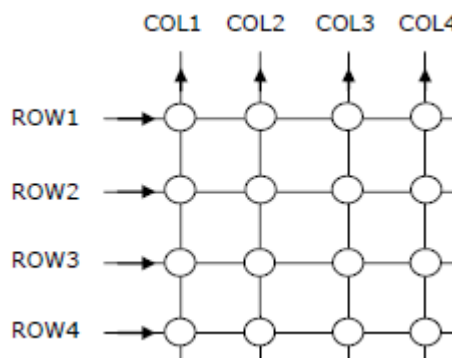

The buttons are connected in a 4×4 matrix to the ROW1–4 (output) and COL1–4 (inputs) terminals. If you do not make use of all of the 16 buttons, you can leave some of the ROW and COL signals unconnected. If you need one button only, connect it to the ROW1 and COL4 terminals.

The button function is programmable. You can set the numerical keypad buttons to any matrix position (0 to 9, *, #) or configure one of the 16 buttons for dialling a telephone directory position.

Caution

- Errors such as false keystroke detection may occur in installations with strong EMI. Therefore, make sure that the keypad or button cables are carried in a trunk separated from the power cables and are as short as possible (up to 1 m).

Connection of External Loudspeaker

2N® Helios IP Video Kit is equipped with an integrated 10 W power amplifier of class D. The amplifier output is available on the SPEAKER+ and SPEAKER– terminals. The maximum power is achievable with a 4 Ω loudspeaker only. The higher the loudspeaker impedance, the lower the maximum power output; refer to the table below:

| Loudspeaker impedance | Maximum power (at +20 dB) |
|-----------------------|---------------------------|
| 4 Ω (min) | 10 W |
| 8 Ω | 5 W |
| 16 Ω | 2.5 W |
| 32 Ω | 1.2 W |
| 64 Ω | 0.6 W |

⚠ Caution

- Never connect a loudspeaker with impedance lower than 4 Ω to avoid system damage.
- Never exceed the maximum power output designated for the loudspeaker to avoid loudspeaker destruction. Choose a loudspeaker with proper impedance and maximum power values, or limit the maximum volume level in the device configuration.
- Use an external power supply to maximise the power output. Make sure that the maximum Master volume value is +6 dB in the Hardware / Audio menu if you use PoE and 4 Ω speaker.

Connection of External Microphone

2N[®] Helios IP Video Kit is equipped with an input for connection of an external electret microphone on the MIC+ and MIC- terminals. Shielding of the shielded cable is connected to the IN- terminal.

⚠ Caution

- Undesired noise may be heard in the earphone where EMI affects the microphone signal. To avoid this, connect the microphone using a shielded cable of the minimum possible length.

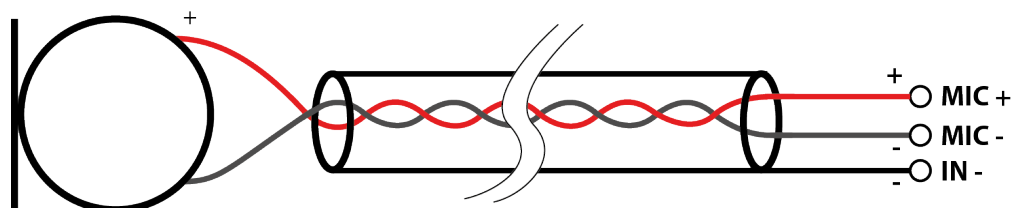

Connection of External Amplifier

2N[®] Helios IP Video Kit is equipped with a line output for connection of an external power amplifier on the LINE OUT+ and LINE OUT- terminals.

Connection of External Audio Source

2N[®] Helios IP Video Kit is equipped with a line input for connection of an external audio signal source (FM tuner, MP3 player, e.g.) on the LINE IN+ and LINE IN- terminals.

Connection to Relay Output

is equipped with one galvanically isolated relay switch with N/O and N/C contacts on the NC, NO and COM terminals. The relay function is programmable.

Warning

- Do not exceed the voltage and current limits for the load connected to the relay contacts as specified in the technical parameters of the device to avoid device damage.

Connection to Digital Outputs

2N® Helios IP Video Kit is equipped with two active 12 V / 650 mA outputs on the OUT1± and OUT2± terminals. The outputs are overload and short-circuit resistant.

Warning

When you connect a device containing a coil, such as a relay or an electromagnetic lock, it is necessary to protect the intercom against voltage peak while switching off the induction load. For this way of protection we recommend a diode 1A / 1000V (e.g., 1N4007, 1N5407, 1N5408) connected antiparallel to the device.

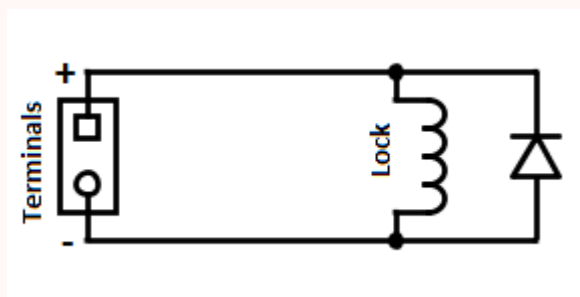

Connection to Digital Inputs

2N® Helios IP Video Kit is equipped with two digital inputs on the IN1± and IN2± terminals. The digital inputs recognise the following two logic levels: log. 0 for voltage under 1.1 V and log. 1 for voltage over 3 V. Keep the voltage polarity to make the function work properly. The function is programmable for either input.

Camera connection

2N® Helios IP Video Kit is equipped with two video inputs for analog camera with composite PAL or NTSC signal. Output from camera connects to VIDEO VGND and VIDEO IN1/IN2 sockets. **2N® Helios IP Video Kit** automatically detects signal format. If the attached camera has no own power supply, it can be supplied from **2N® Helios IP Video Kit** from VIDEO +12 V and VIDEO VGND sockets.

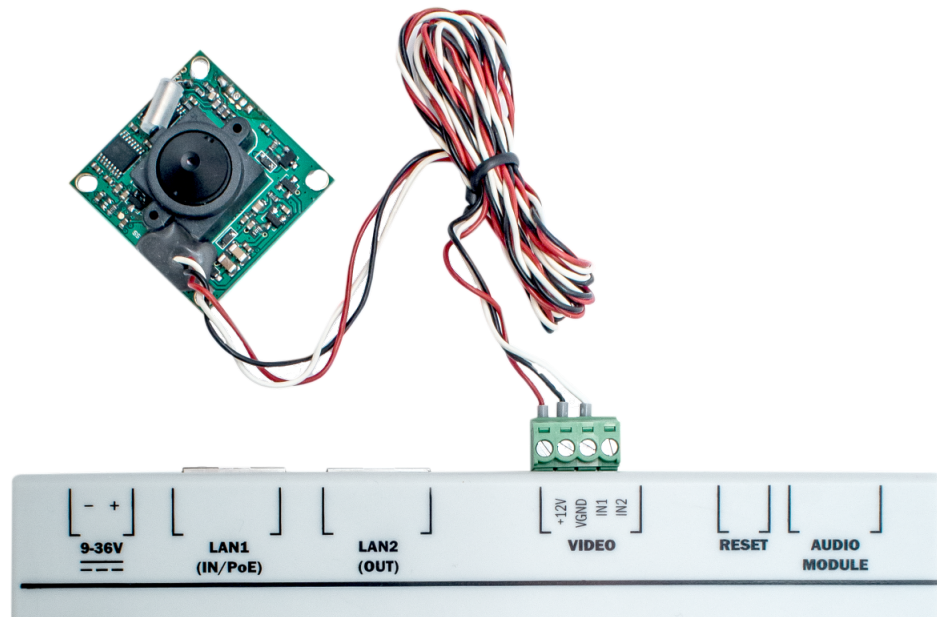

2.5 Configuration

Device Configuration

Configure **2N® Helios IP Video Kit** using a PC equipped any web browser as follows:

- Launch your web browser (Internet Explorer, Firefox, etc.).
- Enter the IP address of your intercom (<http://192.168.1.100/>, e.g.).
- Log in with username **Admin** and password **2n**.

You have to know the IP address of your device to log in to the integrated web server. Upon purchase, **2N® Helios IP Video Kit** is in the Dynamic IP address mode, i.e. it obtains the IP address automatically if there is an adequately set DHCP server in the LAN. If no such server is available, set the Static IP address mode to your **2N® Helios IP Video Kit**.

If the device remains inaccessible (you have forgotten the IP address or the LAN configuration has changed, e.g.), change the network settings using the RESET button on the device.

LAN Setting Change and Default Reset

2N® Helios IP Video Kit is equipped with a RESET button. Press the button shortly (< 1 s) to restart the system without changing configuration.

Follow the instructions below to **identify the current IP address**:

- Connect the loudspeaker to the SPEAKER terminals.
- Press and hold the REST button.
- Wait until the red and green LEDs on the device come on simultaneously (approx. 15 s).
- Release the RESET button.
- The device announces the current IP address via the loudspeaker connected automatically.

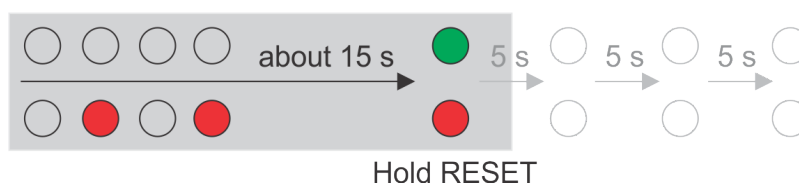

Follow the instructions below to switch on the **Static IP address** mode (DHCP OFF):

- Press and hold the REST button.
- Wait until the red and green LEDs on the device come on simultaneously (approx. 15 s).
- Wait until the red LED goes off (approx. 5 s).
- Release the RESET button.

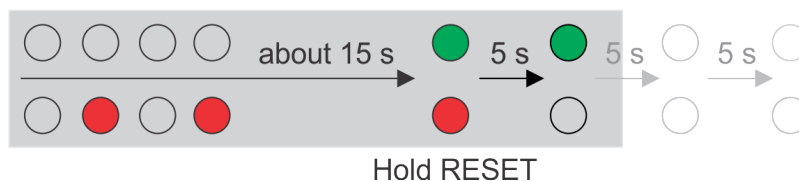

The following network parameters will be set after restart:

- IP address: 192.168.1.100
- Network mask: 255.255.255.0
- Default gateway: 192.168.1.1

Follow the instructions below to switch on the **Dynamic IP address** mode (DCHP ON):

- Press and hold the REST button.
- Wait until the red and green LEDs on the device come on simultaneously (approx. 15 s).
- Wait until the red LED goes off (approx. 5 s).
- Wait until the green LED goes off and the red LED comes on again (another 5 s).
- Release the RESET button.

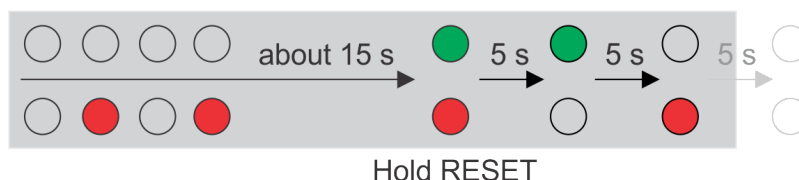

Follow the instructions below to **reset the factory default values**:

- Press and hold the REST button.
- Wait until the red and green LEDs on the device come on simultaneously (approx. 15 s).
- Wait until the red LED goes off (approx. 5 s).
- Wait until the green LED goes off and the red LED comes on again (approx. 5 s).
- Wait until the red LED goes off (another 5 s).
- Release the RESET button.

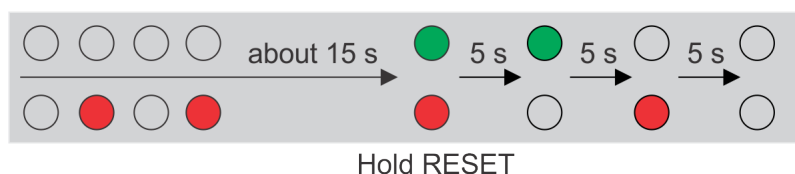

2.4 Extending Module Connection

2N® Helios IP Video Kit allows to connect following extending modules:

- [Security Relay](#)

Security Relay

The **Security Relay** (Part No. 9159010) is used for enhancing security between the intercom and the connected electric lock. The **2N® Helios IP Security Relay** is designed for any **2N® Helios IP** intercom model with firmware versions 1.15 and higher. It significantly enhances security of the connected electric lock as it prevents lock opening by forced intercom tampering.



Function:

The **2N® Helios IP Security Relay** is a device installed between an intercom (outside the secured area) and the electric lock (inside the secured area). The **2N® Helios IP Security Relay** includes a relay that can only be activated if the valid opening code is received from the intercom.

Specifications:

- Passive switch: NO and NC contacts, up to 30 V / 1 A AC/DC
- Active switch output: 12 V / 700 mA DC
- Dimensions: (56 × 31 × 24) mm
- Weight: 20 g

Installation:

Install the **2N® Helios IP Security Relay** onto a two-wire cable between the intercom and the electric lock inside the area to be secured (typically behind the door). The device is powered and controlled via this two-wire cable and so can be added to an existing installation. Thanks to its compact dimensions, the device can be installed into a standard mounting box.

Connection:

Connect the **2N® Helios IP Security Relay** to the intercom as follows:

- To the intercom active output (OUT1 or OUT2) , or
- To the intercom relay output with a 12 V DC serial external power supply.

Connect the electric lock to the **2N® Helios IP Security Relay** output as follows:

- To the active 12 V / 700 mA DC output, or
- To the relay output with a serial external power supply.

The device also supports a Departure button connected between the 'PB' and '- HeliosIP' terminals. Press the Departure button to activate the output for 5 seconds.

Status signalling:

| Green LED | Red LED | Status |
|-----------|----------|---|
| blinking | off | Operational mode |
| on | off | Activated output |
| blinking | blinking | Programming mode – waiting for initialisation |
| on | blinking | Error – wrong code received |

Configuration:

- Connect the **2N® Helios IP Security Relay** to the properly set intercom switch output; refer to the **2N® Helios IP Configuration Manual**. Make sure that one LED at least on the **2N® Helios IP Security Relay** is on or blinking.
- Press and hold the **2N® Helios IP Security Relay** Reset button for 5 seconds to put the device in the programming mode (both the red and green LEDs are blinking).
- Activate the intercom switch using the keypad, telephone, etc. The first code sent from the intercom will be stored in the memory and considered valid. After code initialisation, the **2N® Helios IP Security Relay** will pass into the operational mode (the green LED is blinking).

✔ Tip

- FAQ: [2N® Helios IP Security Relay – what it is and how to use it with 2N® Helios IP intercom?](#)

✔ Tip

- Video Tutorial: [Door intercoms 2N® Helios IP - Security Relay](#)

Connection:

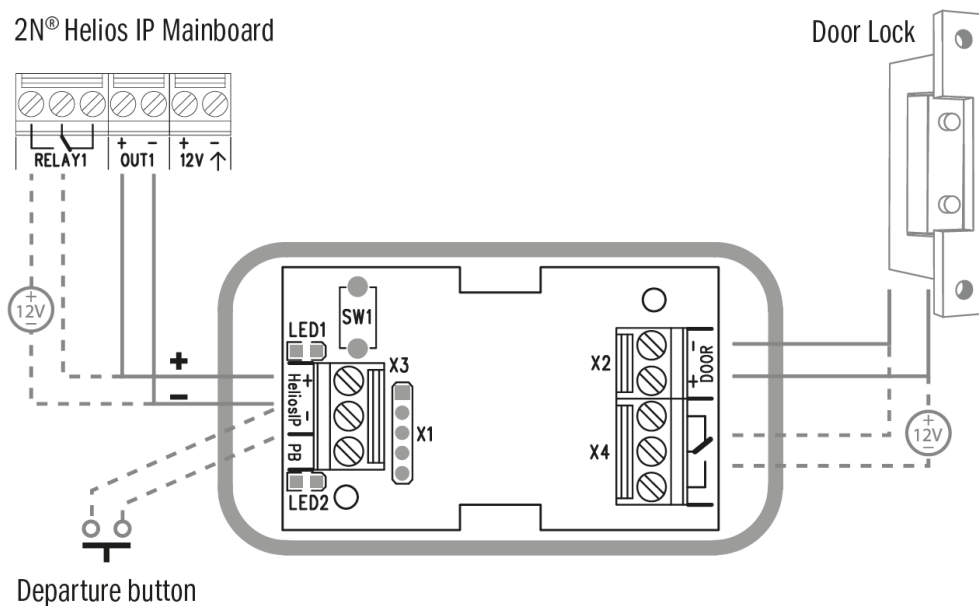

3. Technical Parameters

Supported Protocols

- **LAN interface:** IPv4, ARP, TCP, UDP, DHCP
- **Device configuration:** HTTP/HTTPS
- **Call signalling:** SIP 2.0 (UDP)
- **Audio data transmission:** RTP (G.711, G.729, G.722, L16/16kHz)
- **Audio streaming:** RTSP
- **Time synchronisation:** SNTP
- **Auto provisioning:** TFTP
- **E-mail sending:** SMTP

Power Supply

- **External power supply:** 9 to 36 V $\pm 10\%$ / 2 A DC or PoE, typically 12 V DC
- **PoE:** 802.3af (Class 0 – up to 12.95 W)
- **Power consumption:** 2 W at relax

 **Note**

- If you feed the device from a DC power source and the supply voltage is lower than 12 V, then the output voltage is limited to the supply voltage value.

LAN Interface

- **LAN interface count:** 2 (LAN1 and LAN2)
- **PoE:** 802.3af on LAN1 only
- **Parameters:** 10/100BASE-TX with Auto-MDIX, RJ-45
- **Recommended cabling:** Cat-5e or higher

Video Interface

- **Video input count:** 2 (IN1, IN2)
- **Video input format:** PAL or NTSC composite signal
- **Camera power supply:** 12 V, max 500 mA (+12 V, VGND)

Video stream

- **Protocols:** RTP / RTSP / HTTP
- **Codecs:** H.263, H.263+, H.264, MPEG-4, M-JPEG
- **IP camera function:** Yes

Audio Interface

- **Microphone input:** Standard electret microphone, Max. $V_{pp} = 100$ mV, $R_{in} = 4,4$ k Ω , $V_{bias} = 1,5$ V
- **Line input:** Max. 755 mV RMS, $R_{in} = 47$ k Ω
- **Amplifier output:** 10 W amplifier of class D, MONO output, THD < 1 %, minimum loudspeaker impedance: 4 Ω
- **Line output:** Max. 755 mV RMS, $R_{out} = 600$ Ω
- **Acoustic echo cancelling:** AEC, full duplex

Button/Keypad Interface

- **Button count:** Up to 16 separate buttons in 4x4 matrix
- **Button function:** User programmable
- **Matrix outputs**
 - 4 (ROW1–4 terminals)
 - $U_{out} < 0.1$ V (L), $U_{out} > 3.2$ V (H), up to 8 mA
- **Matrix inputs**
 - 4 (COL1–4 terminals)
 - $U_{in} < 1.15$ (L), $U_{in} > 2.15$ V, max. $U_{in} = 5$ V

LED Control Outputs

- **Output count:** 3 (LED1 \pm , LED2 \pm and LED3 \pm terminals)
- **Output function:** User programmable
- **Output current:** Typ. 20 mA
- **Output voltage:** Up to 12 V

Digital Outputs

- **Output count:** 2 (OUT1 \pm and OUT2 \pm terminals)
- **Output function:** User programmable
- **Output type:** Power output with short-circuit protection
- **Output voltage**
 - PoE power supply: 10 V DC
 - External power supply: Power supply voltage minus 2 V, maximum 11 V DC
- **Output current:** Up to 400 mA

Digital Inputs

- **Input count:** 2 (IN1± and IN2± terminals)
- **Input function:** User programmable
- **Input type:** Galvanically isolated inputs (opto-couplers)
- **Characteristics:** $U_{in} < 1.1 \text{ V (L)}$, $U_{in} > 3 \text{ V (H)}$, max. $U_{in} = 32 \text{ V}$

Relay Output

- **Output count:** 1 (NC, NO, COM terminals)
- **Output function:** User programmable
- **Limits (DC):** Up to 30 V DC / 1 A
- **Limits (AC):** Up to 125 V AC / 0.3 A

Mechanical Properties

- **Working temperature:** $-40^{\circ}\text{C} - 55^{\circ}\text{C}$
- **Working relative humidity:** 10% - 95% (non-condensing)
- **Storing temperature:** $-40^{\circ}\text{C} - 70^{\circ}\text{C}$
- **Dimensions**
 - 142 × 98 × 34 mm (Part No. 9154100)
 - 138 × 90 × 26 mm (Part No. 9154101)
- **Weight**
 - Up to 280 g (Part No. 9154100)
 - Up to 150 g (Part No. 9154101)
- **Protection class**
 - IP20 (Part No. 9154100)
 - IP00 (Part No. 9154101)

4. Supplementary Information

Here is what you can find in this section:

- [4.1 Troubleshooting](#)
- [4.2 Directives, Laws and Regulations](#)
- [4.3 General Instructions and Cautions](#)

4.1 Troubleshooting



For the most frequently asked questions refer to faq.2n.cz.

4.2 Directives, Laws and Regulations

Europe

2N® Helios IP Video Kit conforms to the following directives and regulations:

Directive 1999/5/EC of the European Parliament and of the Council, of 9 March 1999 – on radio equipment and telecommunications terminal equipment and the mutual recognition of their conformity

Directive 2006/95/EC of the European Parliament and of the Council of 12 December 2006 on the harmonisation of the laws of Member States relating to electrical equipment designed for use within certain voltage limits

Directive 2004/108/EC of the Council of 15 December 2004 on the harmonisation of the laws of Member States relating to electromagnetic compatibility

Commission Regulation (EC) No. 1275/2008, of 17 December 2008, implementing Directive 2005/32/EC of the European Parliament and of the Council with regard to ecodesign requirements for standby and off mode electric power consumption of electrical and electronic household and office equipment

Directive 2011/65/EU of the European Parliament and of the Council of 8 June 2011 on the restriction of the use of certain hazardous substances in electrical and electronic equipment

Regulation (EC) No. 1907/2006 of the European Parliament and of the Council of 18 December 2006 concerning the Registration, Evaluation, Authorisation and Restriction of Chemicals (REACH), establishing a European Chemicals Agency, amending Directive 1999/45/EC and repealing Council Regulation (EEC) No. 793/93 and Commission Regulation (EC) No. 1488/94 as well as Council Directive 76/769/EEC and Commission Directives 91/155/EEC, 93/67/EEC, 93/105/EC and 2000/21/EC

Directive 2012/19/EC of the European Parliament and of the Council of 4 July 2012 on waste electrical and electronic equipment.

4.3 General Instructions and Cautions

Please read this User Manual carefully before using the product. Follow all instructions and recommendations included herein.

Any use of the product that is in contradiction with the instructions provided herein may result in malfunction, damage or destruction of the product.

The manufacturer shall not be liable and responsible for any damage incurred as a result of a use of the product other than that included herein, namely undue application and disobedience of the recommendations and warnings in contradiction herewith.

Any use or connection of the product other than those included herein shall be considered undue and the manufacturer shall not be liable for any consequences arisen as a result of such misconduct.

Moreover, the manufacturer shall not be liable for any damage or destruction of the product incurred as a result of misplacement, incompetent installation and/or undue operation and use of the product in contradiction herewith.

The manufacturer assumes no responsibility for any malfunction, damage or destruction of the product caused by incompetent replacement of parts or due to the use of reproduction parts or components.

The manufacturer shall not be liable and responsible for any loss or damage incurred as a result of a natural disaster or any other unfavourable natural condition.

The manufacturer shall not be held liable for any damage of the product arising during the shipping thereof.

The manufacturer shall not make any warrant with regard to data loss or damage.

The manufacturer shall not be liable and responsible for any direct or indirect damage incurred as a result of a use of the product in contradiction herewith or a failure of the product due to a use in contradiction herewith.

All applicable legal regulations concerning the product installation and use as well as provisions of technical standards on electric installations have to be obeyed. The manufacturer shall not be liable and responsible for damage or destruction of the product or damage incurred by the consumer in case the product is used and handled contrary to the said regulations and provisions.

The consumer shall, at its own expense, obtain software protection of the product. The manufacturer shall not be held liable and responsible for any damage incurred as a result of the use of deficient or substandard security software.

The consumer shall, without delay, change the access password for the product after installation. The manufacturer shall not be held liable or responsible for any damage incurred by the consumer in connection with the use of the original password.

The manufacturer also assumes no responsibility for additional costs incurred by the consumer as a result of making calls using a line with an increased tariff.

Electric Waste and Used Battery Pack Handling



Do not place used electric devices and battery packs into municipal waste containers. An undue disposal thereof might impair the environment!

Deliver your expired electric appliances and battery packs removed from them to dedicated dumpsites or containers or give them back to the dealer or manufacturer for environmental-friendly disposal. The dealer or manufacturer shall take the product back free of charge and without requiring another purchase. Make sure that the devices to be disposed of are complete.

Do not throw battery packs into fire. Battery packs may not be taken into parts or short-circuited either.

**2N TELEKOMUNIKACE a.s.**

Modřanská 621, 143 01 Prague 4, Czech Republic

Phone: +420 261 301 500, Fax: +420 261 301 599

E-mail: sales@2n.cz

Web: www.2n.cz

EN1941_v2.1